



T 560-1
60 US^t Lifting Capacity
Truck Crane
Datasheet
Imperial

T 560-1



Features: T 560-1

- ▶ 60 US^t maximum lifting capacity
- ▶ 110 ft maximum boom length
- ▶ 170 ft maximum tip height
- ▶ Air-ride suspension
- ▶ Travel speeds up to 65 mph

WORKS FOR YOU.™

Key

.....	3
-------	---

Dimensions

Crane dimensions	4, 5
Crane weights	6
Range diagram	7

Load charts

16,500 lb counterweight

Main boom, outriggers fully extended (100%), 360°	8
Main boom, outriggers fully extended (100%), over rear	8
Main boom, 33 ft offsettable jib, 360°	9
Main boom, 57 ft offsettable jib, 360°	9
Main boom, on tires	9

11,500 lb counterweight

Main boom, outriggers fully extended (100%), 360°	10
Main boom, outriggers fully extended (100%), over rear	10
Main boom, 33 ft offsettable jib, 360°	11
Main boom, 57 ft offsettable jib, 360°	11
Main boom, on tires	11

7,500 lb counterweight

Main boom, outriggers fully extended (100%), 360°	12
Main boom, outriggers fully extended (100%), over rear	12
Main boom, 33 ft offsettable jib, 360°	13
Main boom, 57 ft offsettable jib, 360°	13
Main boom, on tires	13

4,500 lb counterweight

Main boom, outriggers fully extended (100%), 360°	14
Main boom, outriggers fully extended (100%), over rear	14
Main boom, on tires	15

Technical description

Boom	16
Hoist, rope, and hook	16, 17
Cab, controls, operator aids and load limiter / load indicator	17
Superstructure	18
Counterweight	18
Tires	18
Vehicle performance	18
Hydraulic system	18
Carrier, engine, and drive-line	19

	Boom length		Hoist speed
	Tip height		Rope – Standard / Optional
	Boom with extension		Rope diameter
	Telescoping mode		Rope length
	Boom angle		Max. line pull
	Working radius		Electrical system
	Max. boom length with extension		Tires
	Main boom with aux head		Engine
	Hook and block		Steering
	Hook and ball		Speed
	Gradeability		Slewing / Allowable slewing range
	Crane / Crane in standard configuration		Slewing brake
	Gross vehicle weight		Main hoist
	Weight on front axle		Auxiliary hoist
	Weight on rear axle		Cab
	Counterweight		Operator aids / Load limiter / Load indicator
	Outriggers		Transmission
	Swing/Rotation		Hydraulics
	Over rear		Heating / Air conditioning
	General performance		

CRANE DIMENSIONS

T 560-1

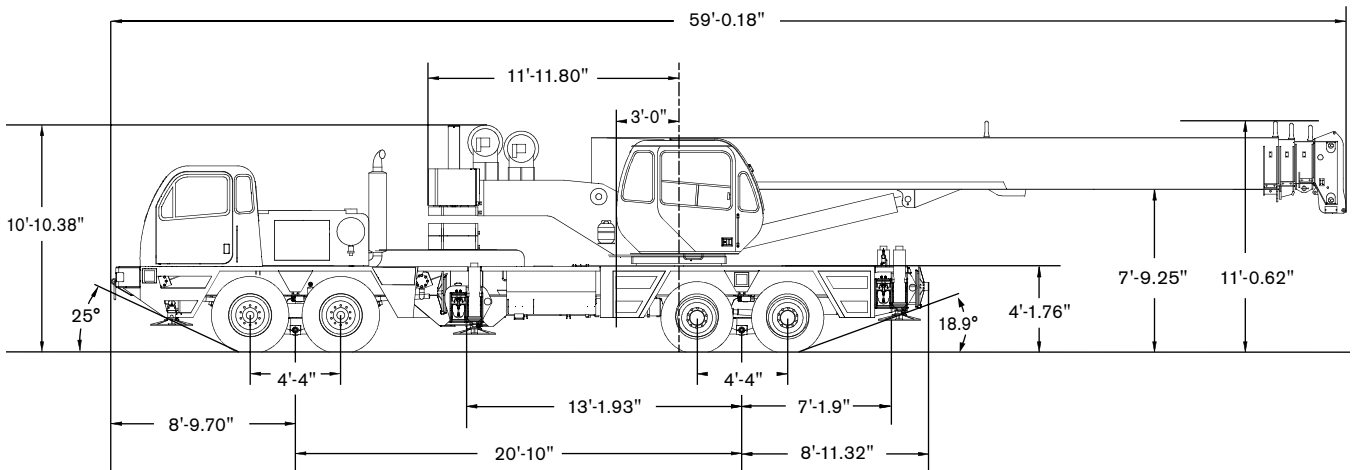
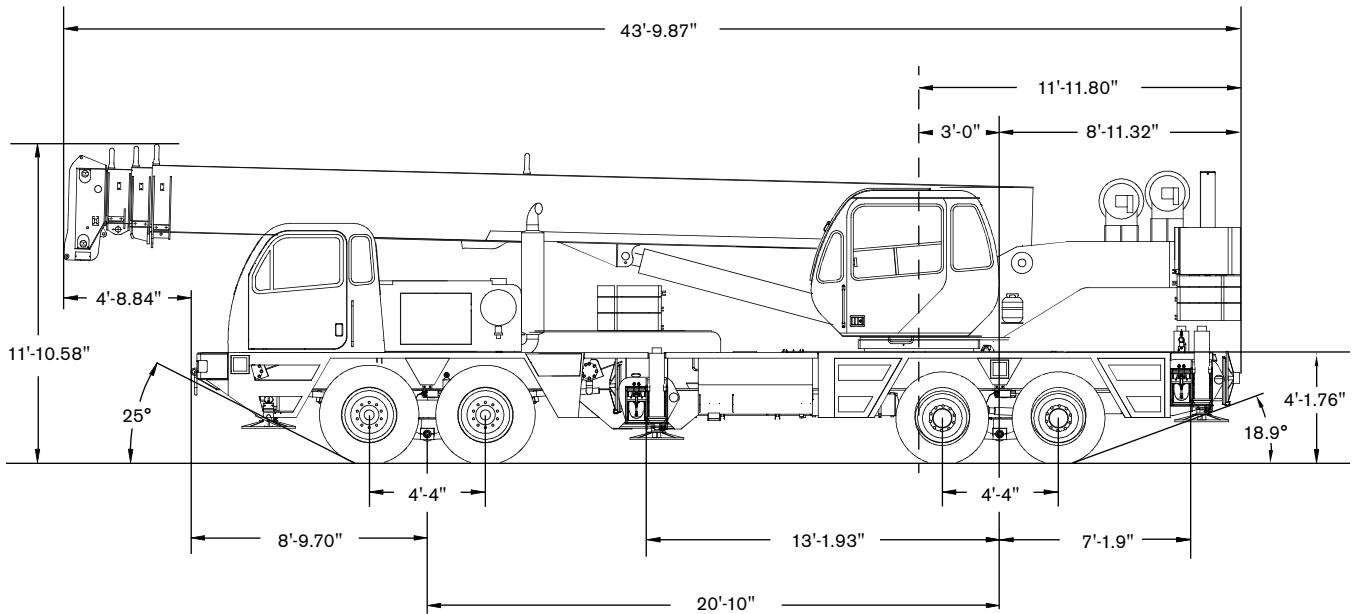

CRANE DIMENSIONS



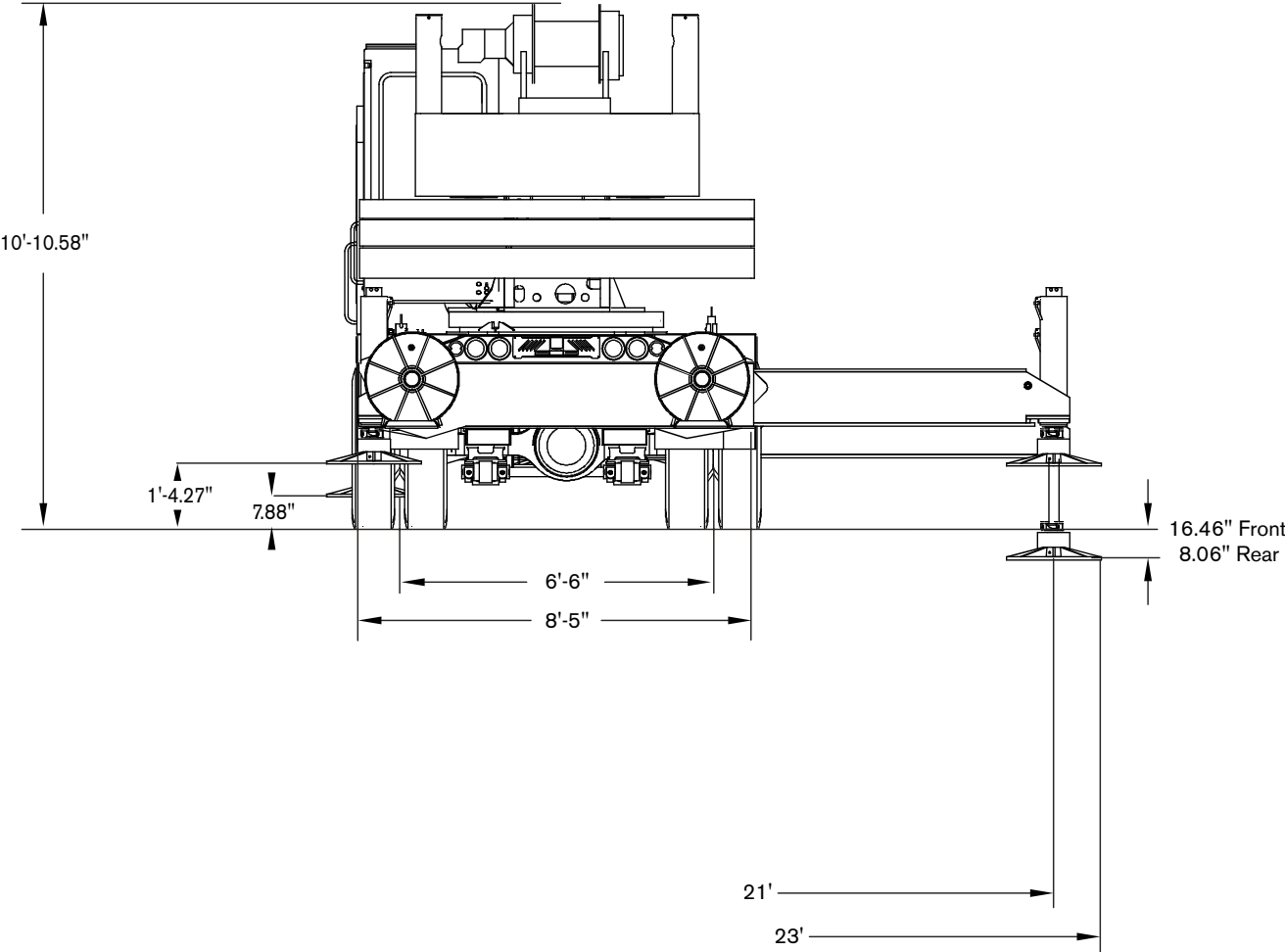





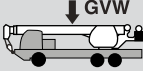
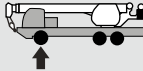
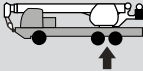
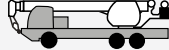

T 560-1



SPECIFICATIONS

T 560-1

Approximate Crane Weights

Boom in front travel position		 Gross Vehicle	 Front max. 44,000 lb	 Rear max. 43,000 lb	
Configuration:					
	1/4 tank fuel 200 lb operator seated in cab Front tires: 425/65 R22.5 Rear tires: 11R22-14PR Load Range G 20PR 110 ft boom/no jib 4,500 lb rear counterweight shell	71,824	33,512	38,311	
Add/subtract options					
	3,000 lb counterweight on rear	+ 3,000	- 1,102	+ 4,102	
	4,000 lb counterweight on rear	+ 4,000	- 1,470	+ 5,470	
	5,000 lb counterweight on rear	+ 5,000	- 1,837	+ 6,387	
	3,000 lb counterweight on crane deck	+ 3,000	+ 1,974	+ 1,026	
	4,000 lb counterweight on crane deck	+ 4,000	+ 2,633	+ 1,367	
	5,000 lb counterweight on crane deck	+ 5,000	+ 3,291	+ 1,709	
	Full tank of fuel	+ 545	+ 244	+ 301	
		Air conditioning in upper cab	+ 150	- 8	+ 158
		Heater/defroster in upper cab	+ 60	+ 4	+ 56
Air conditioning in lower cab		+ 100	+ 112	- 12	
	Auxiliary hoist with drum roller and 600 ft of 16 x 9 class wire rope	+ 87	+ 51	+ 36	
		Spin resistant wire rope – main hoist	+ 90	- 19	+ 109
Spin resistant wire rope – auxiliary hoist		+ 90	- 27	+ 117	
	Electric remote control	+ 200	+ 100	+ 100	
	32 ft swing-on jib	+ 1,270	+ 1,194	+ 76	
	32 ft to 57 ft extendable swing-on jib	+ 2,170	+ 1,922	+ 248	
	Auxiliary boom head	+ 100	+ 168	- 68	
	60 USt hook block on bumper 5 sheave, quick reeving	+ 1,157	+ 1,839	- 688	
	40 USt hook block on bumper 4 sheave, quick reeving	+ 690	+ 1,104	- 412	
	7 USt hook and ball on bumper	+ 340	+ 383	- 43	

RANGE DIAGRAM - MAIN BOOM

T 560-1

Outriggers Fully Extended (100%)

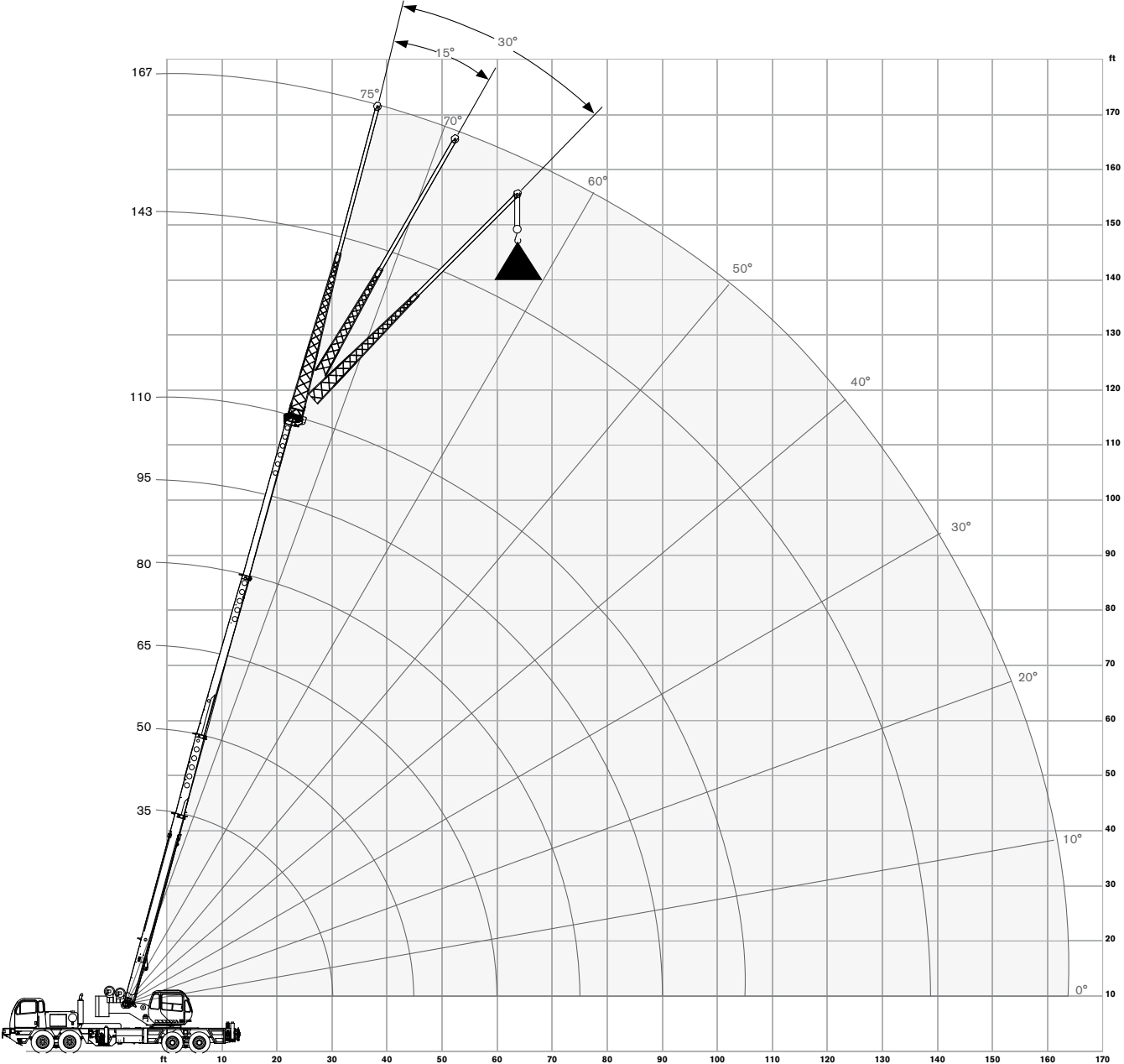

LOAD CHART - MAIN BOOM

T 560-1

Outriggers Fully Extended (100%)

 16,500 lb

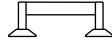
 100%

 360°

 35-110 ft

Standard ASME
B30.5

		Boom Length (ft)							
		35	50	65	80	95	110		
ft	lb	lb	lb	lb	lb	lb	lb	ft	
10	120,000	80,000						10	
12	100,700	80,000						12	
15	82,800	78,400	61,900					15	
20	62,500	63,300	54,800	46,200				20	
25	48,300	49,600	49,100	40,700	35,300			25	
30	36,700	38,600	39,100	36,000	31,100	27,500		30	
35		29,100	29,700	30,000	28,000	24,800		35	
40		22,700	23,400	23,800	24,000	22,500		40	
45		18,100	19,000	19,300	19,500	19,600		45	
50			15,600	16,000	16,200	16,300		50	
55			12,900	13,400	13,600	13,700		55	
60			10,700	11,300	11,500	11,700		60	
65				9,600	9,800	10,000		65	
70				8,100	8,400	8,600		70	
75				6,800	7,200	7,400		75	
80					6,200	6,400		80	
85					5,200	5,500		85	
90					4,400	4,700		90	
95						4,000		95	
100						3,300		100	
105						2,700		105	

Outriggers Fully Extended (100%)

 16,500 lb

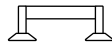
 100%

 Over Rear

 35-110 ft

Standard ASME
B30.5

		Boom Length (ft)							
		35	50	65	80	95	110		
ft	lb	lb	lb	lb	lb	lb	lb	ft	
10	120,000	80,000						10	
12	107,000	80,000						12	
15	87,100	78,400	61,900					15	
20	62,900	63,300	54,800	46,200				20	
25	48,300	49,600	49,100	40,700	35,300			25	
30	36,800	39,900	40,500	36,000	31,100	27,500		30	
35		32,800	33,500	32,200	28,000	24,800		35	
40		27,500	28,300	28,700	25,200	22,500		40	
45		22,200	24,200	24,600	23,100	20,600		45	
50			20,800	21,300	21,300	18,800		50	
55			17,900	18,400	18,600	17,400		55	
60			14,700	15,800	16,000	16,200		60	
65				13,600	13,900	14,100		65	
70				11,900	12,200	12,300		70	
75				10,300	10,700	10,900		75	
80					9,400	9,600		80	
85					8,200	8,500		85	
90					7,200	7,500		90	
95						6,600		95	
100						5,800		100	
105						5,100		105	

Notes to lifting capacity

Lifting capacities do not exceed 85% of tipping load. Weight of hook blocks and slings is part of the load, and is to be deducted from the capacity ratings. Consult operation manual for further details.

Note: Data published herein is intended as a guide only and shall not be construed to warrant applicability for lifting purposes. Crane operation is subject to the computer charts and operation manual both supplied with the crane.

LOAD CHART - MAIN BOOM

T 560-1

With Offset Jibs

 16,500 lb

 100%

 360°

Standard ASME
B30.5

33 ft Offsettable Jib					
0° Offset		15° Offset		30° Offset	
ft	lb	ft	lb	ft	lb
37	12,500	48	8,500	54	6,400
43	11,800	53	8,100	59	6,200
48	11,200	58	7,800	63	6,100
56	10,300	65	7,500	70	5,900
64	9,500	72	7,100	76	5,900
71	8,700	78	6,700	82	5,600
78	7,400	74	6,400	88	5,400
86	5,900	92	5,400	95	5,100
94	4,800	99	4,400	102	4,200
101	3,800	106	3,600	108	3,500
108	3,100	112	2,900	114	2,900
115	2,400	118	2,200	120	2,200
123	1,700	125	1,600	126	1,600
130	1,000	131	900		
136		136			

57 ft Offsettable Jib					
0° Offset		15° Offset		30° Offset	
ft	lb	ft	lb	ft	lb
48	6,500	63	4,500	73	3,300
54	6,400	69	4,300	78	3,200
60	6,200	74	4,100	83	3,100
69	6,000	82	3,900	90	3,000
78	5,400	90	3,700	97	2,900
86	4,900	97	3,500	103	2,800
94	4,500	104	3,300	109	2,700
103	4,200	112	3,100	117	2,600
112	3,700	120	2,900	124	2,500
120	3,000	127	2,700	130	2,500
128	2,400	134	2,200	136	2,100
136	1,800	141	1,700	142	1,600
145	1,300	148	1,100	149	1,200
153	700	155			
159		160			

On Tires

 16,500 lb

 On tires

 Over Rear

Standard ASME
B30.5

Boom		Travel Speed: Boom straight over rear		
ft	ft	0 mph	Creep	2.5 mph
		lb	lb	lb
10	35	26,800	16,400	10,300
12	35	24,300	14,600	8,900
15	35	21,100	12,300	7,200
20	50	17,000	9,300	4,900
25	50	13,800	7,000	3,100
30	50	11,100	5,100	
35	50	9,200	3,700	
40	65	7,800	2,800	
45	65	6,700	2,100	
50	65	5,700		
55	65	4,800		
60	80	3,800		
65	80	3,000		
70	95	2,300		
75	95	1,800		

Notes to lifting capacity

Lifting capacities do not exceed 85% of tipping load, (75% of tipping load on tires). Weight of hook blocks and slings is part of the load, and is to be deducted from the capacity ratings. Consult operation manual for further details.

Note: Data published herein is intended as a guide only and shall not be construed to warrant applicability for lifting purposes. Crane operation is subject to the computer charts and operation manual both supplied with the crane.

LOAD CHART - MAIN BOOM

T 560-1

Outriggers Fully Extended (100%)

 11,500 lb

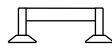
 100%

 360°

 35-110 ft

Standard ASME
B30.5

	Boom Length (ft)						
	35	50	65	80	95	110	
ft	lb	lb	lb	lb	lb	lb	ft
10	120,000	80,000					10
12	98,500	80,000					12
15	80,800	78,400	61,900				15
20	60,400	61,600	54,800	46,200			20
25	46,200	47,600	48,200	40,700	35,300		25
30	32,400	34,200	34,800	35,100	31,100	27,500	30
35		25,600	26,200	26,500	26,700	24,800	35
40		19,800	20,500	20,800	21,000	21,200	40
45		15,600	16,500	16,800	17,000	17,100	45
50			13,400	13,800	14,000	14,100	50
55			11,000	11,400	11,600	11,800	55
60			9,000	9,500	9,800	9,900	60
65				7,900	8,200	8,400	65
70				6,600	6,900	7,100	70
75					5,800	6,000	75
80					4,900	5,100	80
85					4,000	4,300	85
90					3,300	3,500	90
95						2,900	95
100						2,300	100
105						1,800	105

Outriggers Fully Extended (100%)

 11,500 lb

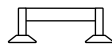
 100%

 Over Rear

 35-110 ft

Standard ASME
B30.5

	Boom Length (ft)						
	35	50	65	80	95	110	
ft	lb	lb	lb	lb	lb	lb	ft
10	120,000	80,000					10
12	106,800	80,000					12
15	83,700	78,400	61,900				15
20	60,400	61,600	54,800	46,200			20
25	46,200	47,600	48,200	40,700	35,300		25
30	36,600	38,100	38,800	36,000	31,100	27,500	30
35		31,400	32,000	32,200	28,000	24,800	35
40		26,200	27,000	27,400	25,200	22,500	40
45		22,200	23,000	23,400	23,100	20,600	45
50			19,200	19,600	19,800	18,800	50
55			16,100	16,600	16,800	16,900	55
60			13,600	14,200	14,400	14,500	60
65				12,200	12,400	12,600	65
70				10,500	10,800	11,000	70
75				9,000	9,400	9,600	75
80					8,200	8,400	80
85					7,100	7,400	85
90					6,200	6,400	90
95						5,600	95
100						4,900	100
105						4,200	105

Notes to lifting capacity

Lifting capacities do not exceed 85% of tipping load. Weight of hook blocks and slings is part of the load, and is to be deducted from the capacity ratings. Consult operation manual for further details.

Note: Data published herein is intended as a guide only and shall not be construed to warrant applicability for lifting purposes. Crane operation is subject to the computer charts and operation manual both supplied with the crane.

LOAD CHART - MAIN BOOM

T 560-1

With Offset Jibs

 11,500 lb

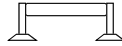
 100%

 360°

Standard ASME
B30.5

33 ft Offsettable Jib					
0° Offset		15° Offset		30° Offset	
ft	lb	ft	lb	ft	lb
39	12,500	48	8,500	54	6,400
44	11,800	53	8,100	59	6,200
49	11,200	58	7,800	63	6,100
57	10,300	65	7,500	70	5,900
64	9,000	71	7,100	77	5,900
71	7,500	78	6,500	83	5,600
78	6300	84	5,500	88	5,200
86	4,900	92	4,400	96	4,200
94	3,700	99	3,500	102	3,300
101	2,900	105	2,800	108	2,600
107	2,200	111	2,100	114	2,000
114	1,600	118	1,500	119	1,400
122	900	125	900	125	800
129		131			
135		136			

57 ft Offsettable Jib					
0° Offset		15° Offset		30° Offset	
ft	lb	ft	lb	ft	lb
47	6,500	64	4,500	73	3,300
54	6,400	69	4,300	78	3,200
60	6,200	75	4,100	83	3,100
69	6,000	83	3,900	90	3,000
78	5,400	90	3,700	97	2,900
86	4,900	97	3,500	103	2,800
94	4,500	104	3,300	109	2,700
104	3,600	113	3,100	117	2,600
113	2,800	120	2,600	124	2,400
121	2,100	128	2,000	130	1,900
128	1,600	134	1,500	136	1,400
136	1,100	141	1,000	142	900
144		148		149	
152		155			
159		160			

On Tires

 11,500 lb

 On tires

 Over Rear

Standard ASME
B30.5

Boom		Travel Speed: Boom straight over rear		
ft	ft	0 mph	Creep	2.5 mph
		lb	lb	lb
10	35	28,100	17,700	11,600
12	35	25,500	15,800	10,200
15	35	22,300	13,400	8,300
20	50	18,000	10,300	5,800
25	50	14,600	7,900	3,900
30	50	11,900	5,800	2,300
35	50	9,600	4,400	1,200
40	65	7,200	3,500	
45	65	5,700	2,700	
50	65	4,600	2,000	
55	65	3,600	1,400	
60	80	2,800		
65	80	1,500		
70	95	1,200		

Notes to lifting capacity

Lifting capacities do not exceed 85% of tipping load, (75% of tipping load on tires). Weight of hook blocks and slings is part of the load, and is to be deducted from the capacity ratings. Consult operation manual for further details.

Note: Data published herein is intended as a guide only and shall not be construed to warrant applicability for lifting purposes. Crane operation is subject to the computer charts and operation manual both supplied with the crane.

LOAD CHART - MAIN BOOM

T 560-1

Outriggers Fully Extended (100%)

 7,500 lb

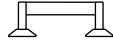
 100%

 360°

 35-110 ft

Standard ASME
B30.5

		Boom Length (ft)							
		35	50	65	80	95	110		
ft	lb	lb	lb	lb	lb	lb	lb	ft	
10	120,000							10	
12	96,800	80,000						12	
15	79,100	78,400	61,900					15	
20	58,300	59,600	54,800	46,200				20	
25	41,300	42,800	43,500	40,700	35,300			25	
30	28,100	29,900	30,500	30,800	31,000	27,500		30	
35		22,200	22,800	23,100	23,300	23,500		35	
40		17,000	17,700	18,000	18,200	18,400		40	
45		13,200	14,100	14,400	14,600	14,700		45	
50			11,300	11,700	11,900	12,000		50	
55			9,100	9,600	9,800	9,900		55	
60			7,300	7,900	8,100	8,200		60	
65				6,400	6,700	6,800		65	
70				5,200	5,500	5,700		70	
75				4,200	4,500	4,700		75	
80					3,700	3,900		80	
85					2,900	3,200		85	
90					2,200	2,500		90	
95						1,900		95	
100						1,400		100	
105						900		105	

Outriggers Fully Extended (100%)

 7,500 lb

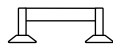
 100%

 Over Rear

 35-110 ft

Standard ASME
B30.5

		Boom Length (ft)							
		35	50	65	80	95	110		
ft	lb	lb	lb	lb	lb	lb	lb	ft	
10	120,000	80,000						10	
12	103,400	80,000						12	
15	81,000	78,400	61,900					15	
20	58,300	59,600	54,800	46,200				20	
25	44,600	45,900	46,600	40,700	35,300			25	
30	35,300	36,800	37,400	36,000	31,100	27,500		30	
35		30,200	30,900	31,300	28,000	24,800		35	
40		24,700	25,400	25,700	25,200	22,500		40	
45		19,800	20,700	21,000	21,200	20,600		45	
50			17,100	17,500	17,700	17,800		50	
55			14,200	14,700	14,900	15,000		55	
60			11,900	12,500	12,700	12,800		60	
65				10,600	10,900	11,000		65	
70				9,100	9,400	9,500		70	
75				7,700	8,100	8,300		75	
80					7,000	7,200		80	
85					6,000	6,200		85	
90					5,100	5,400		90	
95						4,600		95	
100						3,900		100	
105						3,300		105	

Notes to lifting capacity

Lifting capacities do not exceed 85% of tipping load. Weight of hook blocks and slings is part of the load, and is to be deducted from the capacity ratings. Consult operation manual for further details.

Note: Data published herein is intended as a guide only and shall not be construed to warrant applicability for lifting purposes. Crane operation is subject to the computer charts and operation manual both supplied with the crane.





LOAD CHART - MAIN BOOM

T 560-1

With Offset Jibs

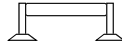
 7,500 lb

 100%

 360°

Standard ASME
B30.5

33 ft Offsettable Jib					
0° Offset		15° Offset		30° Offset	
ft	lb	ft	lb	ft	lb
39	12,500	48	8,500	54	6,400
44	11,800	53	8,100	59	6,200
50	11,200	58	7,800	64	6,100
57	10,100	65	7,500	70	5,900
65	8,000	72	6,700	76	5,900
72	6,300	78	5,500	83	5,000
78	5,100	84	4,500	88	4,100
86	3,800	92	3,400	95	3,100
94	2,900	99	2,600	102	2,400
101	2,100	106	1,900	108	1,800
107	1,500	111	1,400	114	1,300
114		118		120	
122		125		126	
129		131			
135		136			

57 ft Offsettable Jib					
0° Offset		15° Offset		30° Offset	
ft	lb	ft	lb	ft	lb
47	6,500	63	4,500	73	3,300
54	6,400	69	4,300	79	3,200
60	6,200	74	4,100	84	3,100
69	6,000	82	3,900	91	3,000
78	5,400	90	3,700	98	2,900
86	4,600	97	3,500	105	2,800
94	3,800	104	3,200	111	2,700
104	2,900	112	2,400	118	2,300
112	2,100	120	1,800	126	1,700
120	1,500	127	1,300	132	1,300
128	900	134	900	137	800
136		141		143	
144		148		149	
152		155			
158		160			

On Tires

 7,500 lb

 On tires

 Over Rear

Standard ASME
B30.5

Boom		Travel Speed: Boom straight over rear		
ft	ft	0 mph	Creep	2.5 mph
		lb	lb	lb
10	35	29,100	18,700	12,700
12	35	26,500	16,800	11,100
15	35	23,200	14,300	9,200
20	50	18,700	11,100	6,600
25	50	14,000	8,500	4,600
30	50	10,900	6,400	2,900
35	50	8,400	5,000	1,800
40	65	6,400	4,000	1,100
45	65	4,900	3,100	
50	65	3,800	2,400	
55	65	2,900	1,800	
60	80	2,200	1,200	
65	80	1,600		

Notes to lifting capacity

Lifting capacities do not exceed 85% of tipping load, (75% of tipping load on tires). Weight of hook blocks and slings is part of the load, and is to be deducted from the capacity ratings. Consult operation manual for further details.

Note: Data published herein is intended as a guide only and shall not be construed to warrant applicability for lifting purposes. Crane operation is subject to the computer charts and operation manual both supplied with the crane.

LOAD CHART - MAIN BOOM

T 560-1

Outriggers Fully Extended (100%)

 4,500 lb

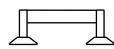
 100%

 360°

 35-110 ft

Standard ASME
B30.5

		Boom Length (ft)							
		35	50	65	80	95	110		
ft	lb	lb	lb	lb	lb	lb	lb	ft	
10	120,000	80,000						10	
12	95,200	80,000						12	
15	77,600	78,400	61,900					15	
20	56,800	58,100	54,800	46,200				20	
25	38,700	40,200	40,900	40,700	35,300			25	
30	26,100	27,900	28,500	28,800	29,000	27,500		30	
35		20,600	21,200	21,500	21,700	21,800		35	
40		15,600	16,300	16,600	16,600	16,800	17,000	40	
45		12,000	12,900	13,200	13,400	13,500		45	
50			10,200	10,600	10,800	10,900		50	
55			8,100	8,600	8,800	8,900		55	
60			6,400	7,000	7,200	7,300		60	
65				5,600	5,900	6,000		65	
70				4,400	4,800	4,900		70	
75				3,400	3,800	4,000		75	
80					3,000	3,200		80	
85					2,300	2,500		85	
90					1,600	1,900		90	
95						1,300		95	
100						800		100	

Outriggers Fully Extended (100%)

 4,500 lb

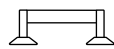
 100%

 Over Rear

 35-110 ft

Standard ASME
B30.5

		Boom Length (ft)							
		35	50	65	80	95	110		
ft	lb	lb	lb	lb	lb	lb	lb	ft	
10	120,000	80,000						10	
12	100,900	80,000						12	
15	78,900	78,400	61,900					15	
20	56,800	58,100	54,800	46,200				20	
25	43,400	44,700	45,300	40,700	35,300			25	
30	34,200	35,700	36,400	36,000	31,100	27,500		30	
35		29,300	29,900	30,200	28,000	24,800		35	
40		22,900	23,700	24,000	24,200	22,500		40	
45		18,300	19,200	19,500	19,700	19,800		45	
50			15,800	16,200	16,400	16,500		50	
55			13,100	13,600	13,800	13,900		55	
60			10,900	11,500	11,700	11,800		60	
65				9,700	10,000	10,100		65	
70				8,200	8,600	8,700		70	
75				6,900	7,300	7,500		75	
80					6,300	6,500		80	
85					5,300	5,600		85	
90					4,500	4,800		90	
95						4,000		95	
100						3,400		100	
105						2,800		105	

Notes to lifting capacity

Lifting capacities do not exceed 85% of tipping load. Weight of hook blocks and slings is part of the load, and is to be deducted from the capacity ratings. Consult operation manual for further details.

Note: Data published herein is intended as a guide only and shall not be construed to warrant applicability for lifting purposes. Crane operation is subject to the computer charts and operation manual both supplied with the crane.



LOAD CHART - MAIN BOOM

T 560-1

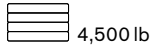

On Tires



4,500 lb



Standard ASME
B30.5











Boom		Travel Speed: Boom straight over rear		
 10 ft	 35 ft	0 mph	Creep	2.5 mph
		lb	lb	lb
10	35	29,900	19,500	13,500
12	35	27,200	17,500	11,900
15	35	23,800	15,000	9,900
20	50	19,300	11,700	7,200
25	50	13,500	9,100	5,100
30	50	9,600	6,900	3,400
35	50	7,200	5,400	2,200
40	65	5,400	4,400	1,400
45	65	4,100	3,500	
50	65	3,000	2,700	
55	65	2,300	2,100	

Notes to lifting capacity

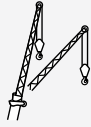



Lifting capacities do not exceed 85% of tipping load, (75% of tipping load on tires). Weight of hook blocks and slings is part of the load, and is to be deducted from the capacity ratings. Consult operation manual for further details.

Note: Data published herein is intended as a guide only and shall not be construed to warrant applicability for lifting purposes. Crane operation is subject to the computer charts and operation manual both supplied with the crane.

Boom

Standard configuration:		
	Full power extension via foot pedal control	4 sections
	Minimum / Maximum	35 ft / 110 ft
	Maximum tip height	114 ft
	Boom elevation angle range (min. / max.)	-4° / 76°
Optional configuration:		
	33 ft swing-on jib, fixed length	
	Angular offsets	0°, 15°, 30°
	Maximum tip height with fixed jib	145 ft
	33–57 ft swing-on jib with adjustable length	
	Angular offsets	0°, 15°, 30°
	Maximum tip height with extended jib	169 ft
	Idler sheaves Quick reeving design	
	Single nylon sheave Installs only on main boom head, compatible with extendable and fixed swing-on jibs	
	Quick reeving with 5 metal sheaves	60 USt
	Quick reeving with 5 metal sheaves	40 USt
	Top swivel ball with hook and latch	7 USt

Hoist, Rope and Hook

Standard configuration:		
	Two speed ratios	
	1st layer without load (low range / high range) 5th layer without load (low range / high range)	184 ft/min / 369 ft/min 266 ft/min / 533 ft/min
	Maximum line pull	
	1st layer (low range / high range) 5th layer (low range / high range)	15,639 lb / 10,827 lb 10,827 lb / 5,052 lb
	Permissible line pull	9,000 lb
	6 x 19 IWRC IPS	
	Rope diameter	5/8 in
	Maximum usable	561 ft

Hoist, Rope and Hook

Optional configuration:



Second Hoist:



Two speed ratios
5th layer without load (high range)

533 ft/min



Maximum line pull
1st layer (low range)
Permissible line pull

15,639 lb

9,000 lb



Rotation resistant compacted strand 6 x 19



Rope diameter

5/8 in

Cab, Controls, Operator aids and Load limiter / Load indicator

Standard configuration:



Upper cab:

Sliding door on left side
Sliding window on the right side
Tilting, tinted glass skylight
Removable front windshield
Six-way adjustable seat with armrest dual-axis electro-proportional joysticks
Joystick control for hoist(s), swing and boom elevation
Foot pedals for swing brake, boom telescope and engine rpm
Hand control for engine rpm

Lower cab:

Hinged door on left side with roll-down window
Sliding window on the right side
Six-way adjustable seat with seatbelt
Cruise control
Two speed windshield wiper with washer



Rated capacity indicator with pictograph display of boom radius, boom angle, boom length, allowable load, actual load and % of allowable load

Settable alarms for swing angle, boom length, boom angle, tip height and work area exclusion zone



Optional configuration:





Upper cab:

Air conditioning – hydraulically powered
Heater and air conditioning package – hydraulically powered
Liquid Propane (LP) Cab Heater
Single-Axis armrest mounted controls
Work Lights
Upper cab remote carrier control

Superstructure

Standard configuration:		
	Foot pedal actuated multi-disc brake and air actuated house lock	360°
	Hydraulic driven double planetary reduction gear drive	2.8 rpm

Counterweight

Standard configuration:		
	Three counterweight configurations are standard	4,500 lb / 7,500 lb / 11,500 lb
Optional configuration:		
	Optional counterweight configuration - 5,000 lb weight cannot be transported on the crane when roading	16,500 lb

Tires

Standard configuration:		
	Aluminium wheels with stainless hub covers Front Tires Rear Tires	425/65 R22.5-18PR 11 R22.5-14PR

Vehicle performance

Standard configuration:		
	Theoretical maximum Automatic transmission	100+ %
	Automatic transmission	65 mph

Hydraulic system

Standard configuration:		
	Three-pump system, Automatic transmission	
	Tandem pump - Main and auxiliary winch; Main boom hoist and telescope	60.3 / 45.1 gal/min @ 3,500 psi
	Single pump - Outriggers and swing	22 gal/min @ 2,500 psi
	Single pump - Power steering	8 gal/min @ 1,500 psi
Three-pump system, Manual transmission:		
Triplex pump -		
Main and auxiliary winch; Main boom hoist and telescope; Swing	60.3 / 45.1 gal/min @ 3,500 psi /	22 gal/min @ 2,500 psi
Single pump - Power steering		8 gal/min @ 1,500 psi
Simultaneous operation of all hydraulic functions		
Two-speed boom extension		
Full Flow with bypass protection:		
Suction		250 micron screen
Return		5 micron filter
Pressurized tank with sight level gauge		
		117 gal

Carrier, Engine and Drive-line

Standard configuration:



Turn radius to centerline of tires

42 ft - 8 in



Axle drive system
Air brakes with ABS, air release / spring set / parking brake

8 x 4 drive

Front axle – maximum capacity
Tubular beam with equalizer air suspension mounting

44,000 lb

Rear axle – maximum capacity
Interaxle differential with lock-out

43,000 lb

Air over equalizer boom suspension

Front and rear



Engine and transmission, EPA 2015 compliant
Detroit Diesel DD13
Intake: Turbocharged and aftercooled
Rated power
Rated torque
Eaton UltraShift Plus fully automated 10-speed transmission
Fuel type
Engine brake

13 L / 450 hp @ 1,800 rpm
1,550 ft-lb @ 1,240 rpm

Ultra low sulfur diesel
Jacobs type

Fuel tank capacity

100 gallon



Voltage
3 Batteries
Alternator

12 VDC
1,000 CCA each
130 amp

Optional configuration:



Engine and transmission, Tier 3. Export only, not for use in U.S. or Canada
Mercedes OM460
Intake: Turbocharged and aftercooled
Rated power
Rated torque
Eaton UltraShift Plus fully automated 10-speed transmission
Fuel type
Engine brake

13 L / 449 hp @ 1,800 rpm
1,475 ft-lb @ 1,300 rpm

Diesel
Exhaust and Jacobs type

Effective Date: March 2017. Product specifications and prices are subject to change without notice or obligation. The photographs and/or drawings in this document are for illustrative purposes only. Refer to the appropriate Operator's Manual for instructions on the proper use of this equipment. Failure to follow the appropriate Operator's Manual when using our equipment or to otherwise act irresponsibly may result in serious injury or death. The only warranty applicable to our equipment is the standard written warranty applicable to the particular product and sale and Terex makes no other warranty, express or implied. Products and services listed may be trademarks, service marks or trade-names of Terex Corporation and/or its subsidiaries in the USA and other countries. All rights are reserved. Terex® is a registered trademark of Terex Corporation in the USA and many other countries. Copyright 2017 Terex Corporation.

Terex Cranes, Global Marketing, Dingerstraße 24, 66482 Zweibrücken, Germany
Tel. +49 (0) 6332 830, Email: info.cranes@terex.com, www.terex.com/cranes



www.terex.com/cranes

Brochure Reference: TC-DS-I-E-TC 560-1-03/17



WORKS FOR YOU.™