

## MR 608

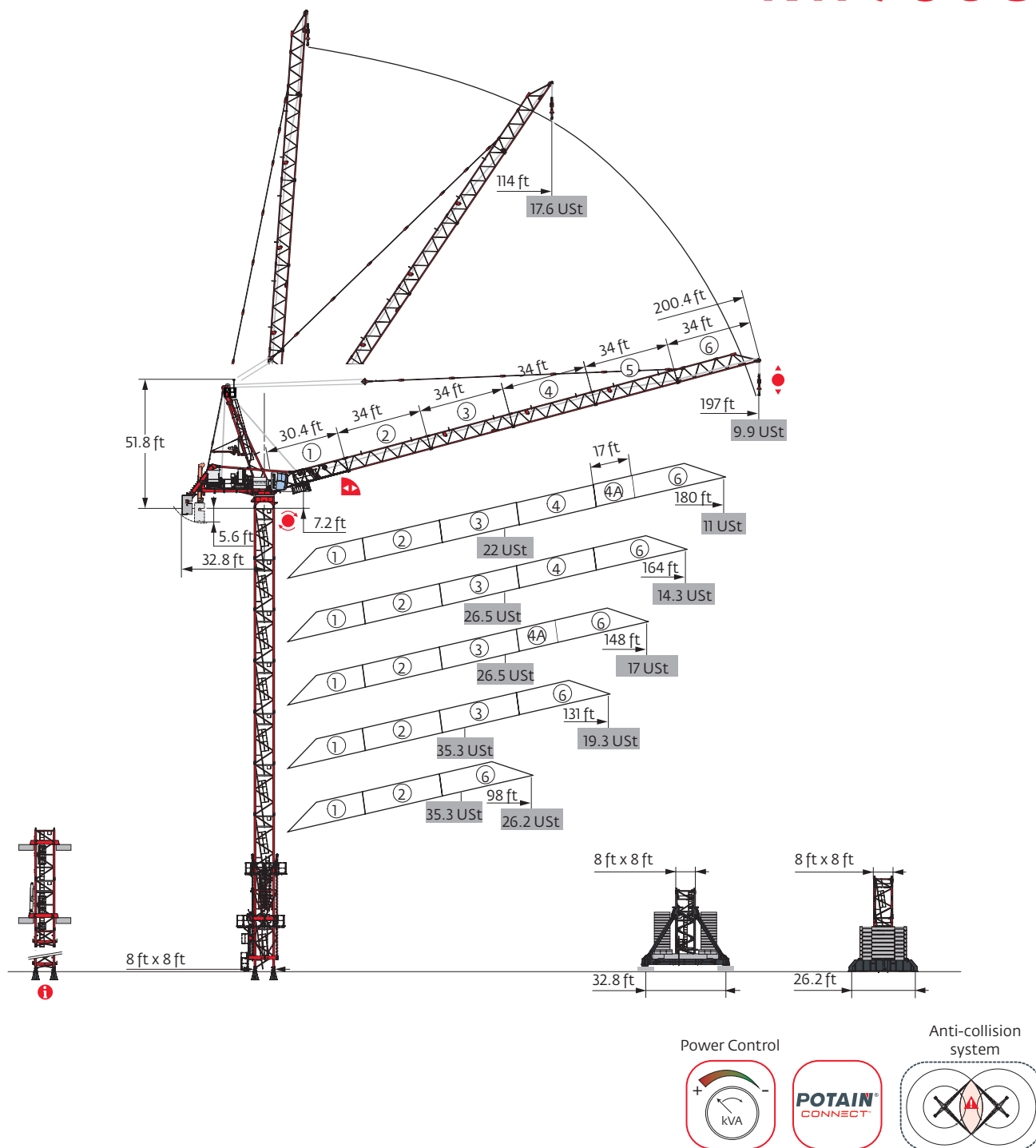

Mast - Reactions

8 ft - P 800B						
Height (ft)	98	131	148	164	180	197
Height (ft)	204.4	193.6	182.4	182.4	182.4	177.2
10.9 ft	0	2	1	1	1	2
16.4 ft	12	10	10	10	10	9
F2 (Ust)	● 294	313	313	311	319	315
	■ 333	351	324	356	384	368
F3 (Ust)	● 189	206	219	219	224	223
	■ 245	261	230	263	289	276

8 ft - P 854A						
Height (ft)	98	131	148	164	180	197
Height (ft)	253.6	253.6	237.2	242.8	237.2	242.8
10.9 ft	0	0	0	2	0	2
16.4 ft	15	15	14	13	14	13
F2 (Ust)	● 353	390	377	381	382	383
	■ 537	620	562	621	618	620
F3 (Ust)	● 233	262	265	271	271	276
	■ 435	510	451	511	506	514

8 ft - JM 850						
Height (ft)	98	131	148	164	180	197
Height (ft)	250.7	239.8	234.3	239.8	234.3	245.1
10.9 ft	0	2	0	2	0	1
16.4 ft	13	11	12	11	12	12
F1 (Ust)	● 159	168	164	174	176	181
	■ 189	196	191	217	218	237

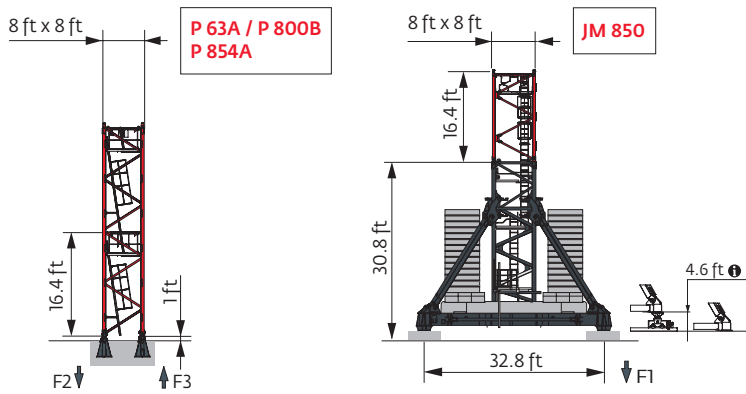

Note: When "ASCE" is noted in this data sheet it is referring to 115 mph Wind Zone, Exposure B, Design Wind Speed = 98 mph. See back cover for design wind speed calculations.

**i** Other mast compositions - Please consult us.

Motorized accesses: adapted mast composition, base ballast and reactions.

**8 ft - ZY 800 -**

▲▲▲▲ (ft)	98	131	148	164	180	197
↕ (ft)	203.4	121.4	99.4	105	99.4	121.4
⌈	10.9 ft	1	1	2	1	2
	16.4 ft	11	6	4	5	4
FI (Ust)	● 168	144	134	130	132	140
	■ 156	112	113	106	101	105

**8 ft - ZY 854 -**

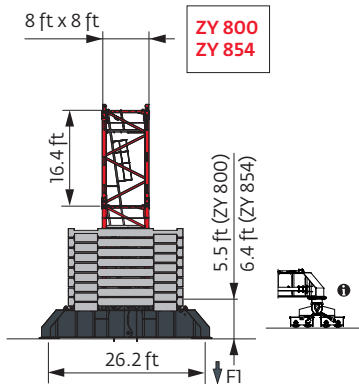

▲▲▲▲ (ft)	98	131	148	164	180	197
↕ (ft)	258.9	248	237.2	237.2	231.6	237.2
⌈	10.9 ft	0	2	1	1	2
	16.4 ft	15	13	13	13	12
FI (Ust)	● 226	235	224	225	223	226
	■ 296	300	279	297	302	304







Anchorage





Base ballast



 (USt) / 8 ft - JM 850 - 							
▽\Δ\Δ (ft)	98	131	148	164	180	197	
250.7	105.8						
245.1	92.6					172	
239.8	92.6	119.1		145.5		158.7	
↓ (ft)	234.3	79.4	105.8	119.1	132.3	158.7	132.3
	217.9	52.9	66.1	79.4	92.6	119.1	105.8
	201.4	52.9	52.9	52.9	66.1	92.6	66.1
	185 ↓	52.9	52.9	52.9	52.9	52.9	52.9
	86.6	52.9	52.9	52.9	52.9	52.9	52.9

 (USt) / 8 ft - ZY 800 - 							
▽\Δ\Δ (ft)	98	131	148	164	180	197	
203.4	119.1						
121.4	92.6	105.8				66.1	
↓ (ft)	105	92.6	105.8		79.4	52.9	
	99.4	92.6	105.8	92.6	79.4	66.1	52.9
	83	92.6	105.8	92.6	79.4	66.1	52.9

 (USt) / 8 ft - ZY 854 - 							
▽\Δ\Δ (ft)	98	131	148	164	180	197	
258.9	211.6						
248	172	224.9					
237.2	145.5	185.2	224.9	224.9		238.1	
↓ (ft)	231.6	132.3	172	211.6	198.4	224.9	224.9
	215.2	119.1	119.1	145.5	158.7	172	185.2
	198.8	105.8	92.6	105.8	119.1	132.3	145.5
	182.4	92.6	92.6	105.8	79.4	92.6	105.8
	166	79.4	92.6	105.8	79.4	79.4	92.6
	149.6	79.4	92.6	105.8	79.4	66.1	79.4
	133.2	79.4	92.6	105.8	79.4	52.9	66.1
	116.8	79.4	92.6	105.8	79.4	52.9	52.9
	100.4	79.4	92.6	105.8	79.4	52.9	52.9
	84	79.4	92.6	105.8	79.4	52.9	39.7

Load curves

▽\Δ\Δ (ft)	77	82	89	98	102	105	115	118	121	131	135	148	154	164	171	180	187	197	ft
 17.6 USt																			
197	18 → 114	17.6	17.6	17.6	17.6	17.6	17.5	-	16.5	15.3	-	13.4	12.9	12	11.6	10.9	10.5	9.9	USt
180	17.4 → 115.5	17.6	17.6	17.6	17.6	17.6	17.6	-	16.8	15.4	15.1	13.7	13	12.2	11.7	11	USt		
164	16 → 135	17.6	17.6	17.6	17.6	17.6	17.6	17.6	17.6	17.6	17.6	16	15.3	14.3	USt				
148	14.8 → 135	17.6	17.6	17.6	17.6	17.6	17.6	17.6	17.6	17.6	17.6	16.2	USt						
131	14 → 131	17.6	17.6	17.6	17.6	17.6	17.6	17.6	17.6	17.6	USt								
98	11 → 98	17.6	17.6	17.6	17.6	USt													

▽\Δ\Δ (ft)	74	77	82	89	98	105	115	121	131	135	148	154	164	171	180	ft	
 35.3 USt																	
180	17.4 → 95	22	22	22	22	21.3	-	-	17	15.7	15.2	13.8	13.1	12.2	11.7	11	USt
164	16 → 93	26.5	26.5	26.5	26.5	24.8	23.1	21.1	19.8	18.2	17.7	16.1	15.3	14.3	USt		
148	14.8 → 93	26.5	26.5	26.5	26.5	25.1	23.6	21.6	20.5	19	18.5	17	USt				
131	14 → 74	35.3	-	31.6	29.2	26.1	24.5	22.3	20.9	19.3	USt						
98	11 → 74	35.3	-	31.7	29.3	26.2	USt										

Jib weight & counter-jib ballast

Height (ft)	Weight (lb) (+/- 5%)	Ballast (lb)	Weight (lb)
197 ft	32,915	10	132,277
180 ft	33,962	10	132,277
164 ft	31,427	10	132,277
148 ft	30,799	10	132,277
131 ft	28,263	9	119,050
98 ft	23,468	8	105,822

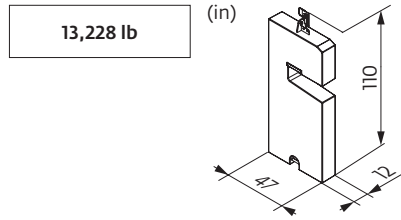

Luffing jib

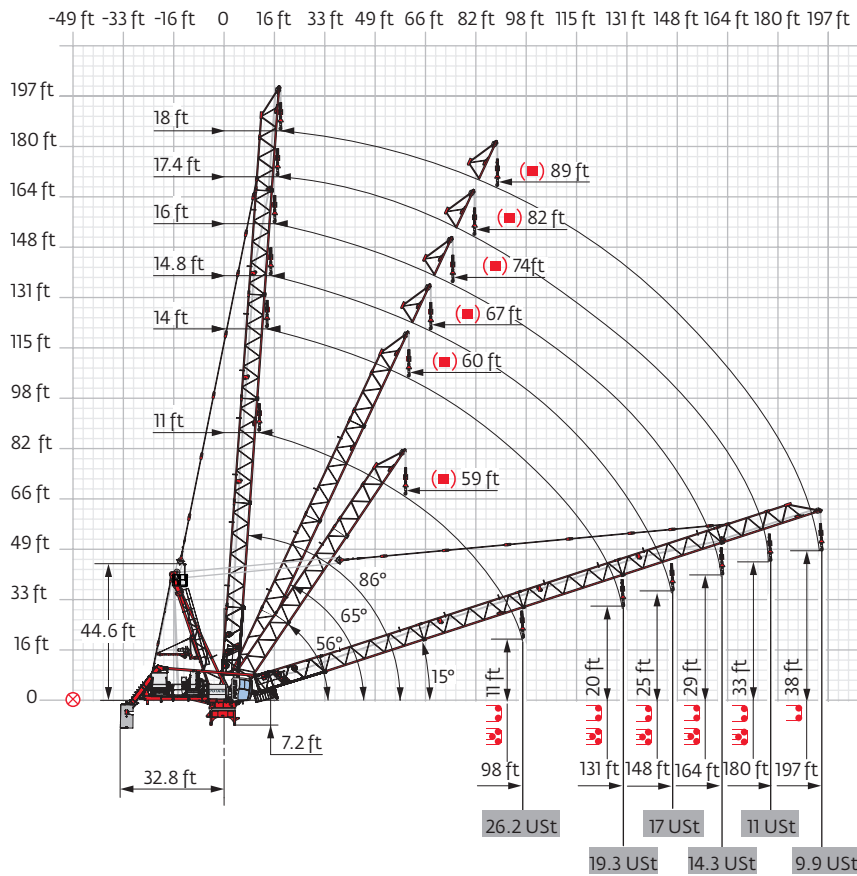





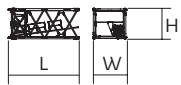
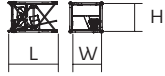
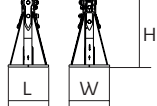
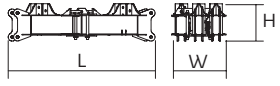

Dimensions and weight

Slewing crane part:  197 ft -  180 HPL™

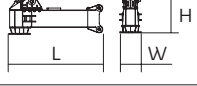

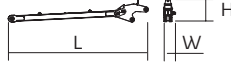
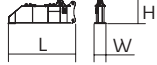
Slewing crane part		L (ft)	W (ft)	H (ft)	lb (+/- 5%)
Counter-jib (+ Grab rail + Platform)		22.6	20.9	7.6	11,541
Strut		9.4	7.8	45.8	20,959
Cab	Ultra View	14.8	6.5	8.4	3,605
Towerhead	8 ft	10.6	11.9	11	26,852
Jib section	① ② ③ ④ ⑤	31.5 34.7 34.7 34.7 34.7	7.2 6.2 6.2 6.2 6.2	7.5 6 6 6 6	6,460 4,211 4,299 3,616 3,086
Jib section	④A	17.7	6.2	6	2,072
Jib section	⑥	34.1	6.2	6	5,291
Pulley block		4.7	1.7	8.9	3,549
Hoisting winch (+ rope)	180 HPL™ 320 LVF	15.8 18.4	6.3 7.2	6.5 7.8	16,788 28,318
Luffing winch (+ rope)	150 VVF	16	5.6	7.1	11,133
Rear left derrick arm (+ auxiliary winch + pulley block)		7.8	3.4	4.3	1,356
Front left derrick arm		11.5	1.4	1.6	419
Articulated derrick arm		13.8	1	1.8	694
Derrick support		6.5	3.6	7.4	1,477

Crane tower		L (ft)	W (ft)	H (ft)	lb (+/- 5%)
Telescopic cage T 851	 $\square$ 8 ft	36.7	15.9	19	34,723
K 85/KR 84B2 KRM 849B KM 850.10B KM 850.14B K 85/KR 84A2 KRMT 849A K 849A KR 849A KMT 849A KMT 850.10A KMT 850.14A	 $\square$ 8 ft	33.6 33.6 33.9 33.9 17.2 17.2 17.2 17.2 17.2 17.5 17.5	8.3 8.4 8.3 8.3 8.3 8.4 8.3 8.3 8.4 8.3 8.3	8.2 8.3 8.2 8.2 8.2 8.3 8.2 8.2 8.3 8.2 8.2	21,242 17,196 22,201 24,670 12,236 9,017 7,496 9,458 6,945 12,015 13,206
KRMT 849C	 $\square$ 8 ft	11.7	8.4	8.3	7,066
Fixing angles	 P 63A / P 800B P 854A	2.5 3	2.5 3	4.2 4.9	1,025 2,072
Central cross (transport position)	 JM 850	17.1	5.6	4.9	14,771
Basic mast unit	 JM 850	28.7	8.2	8.2	32,187
Chassis girder	 JM 850	17.1	3	5.1	7,055
Chassis ties	 JM 850	23.6	0.8	1.1	551
Struts	 JM 850	26.9	2.5	4.3	5,071
1/2 Cross girder	 ZY 800 ZY 854	18.6 18.7	3.2 3.2	6.3 7.4	10,406 14,176
Cross girder	 ZY 800 ZY 854	39.2 39	4.6 4.7	6.3 7.4	22,212 30,865

Mechanisms

480 V - 60 Hz													hp	kW	
	180 HPL™ 80	fpm	138	171	228	359	504	69	85	115	184	251	180	132	2,385 ft
		USt	17.6	13.2	8.8	4.4	2.1	35.3	26.5	17.6	8.8	5.2			
	320 LVF 80 Optima	fpm	246	322	449	640	669	125	161	226	318	335	320	240	3,432 ft
		USt	17.6	13.2	8.8	5.5	4.5	35.3	26.5	17.6	12.2	10.4			
	150 VVF 71		2 min 05 s									150	110		
	RVF 173 Optima +	rpm	0 → 1									3 x 10	3 x 7.5		

	<b>IEC 60204-32</b>		<b>kVA</b>
	480 V (+6% -10%) 60 Hz		180 HPL™ + 150 VVF: 293 → 161 kVA 320 LVF + 150 VVF: 405 → 217 kVA

These mast combinations meet the EN 14439 and ASME B30.3-2016 specifications for “out of service” wind conditions, provided the illustrated wind speed matches required design wind speed for the location of the tower crane. The “out of service” design wind speed was determined in accordance with ASCE 7-10, Figure 26.5-1A. The wind velocity, used for this configuration was 98 mph (158 kph), which represents a nominal design 3-second wind gust at 33 ft (10 m) above ground for Exposure B category. A factor of 0.85 was applied to the 700-year ultimate design wind speed of 115 mph (185 kph), per ASCE 37-02, with the assumption that this crane is considered a temporary structure used during a construction period of 2 years or less.

- Standard equipment
- Options
- Reactions in service
- Reactions out of service
- Jib weight
- Total ballast weight
- Jib articulation axis
- Weather vaning position
- Lorry 44 ft
- Container High Cube 40 ft, and/or Flat Rack 20 ft
- Hoisting
- Luffing
- Slewing
- Travelling
- Required power
- Power Control Function: winch speeds adapted to the available power
- Consult us

This commercial document is not legally binding. For any technical information, please refer to the corresponding instructions.

