

MR 229

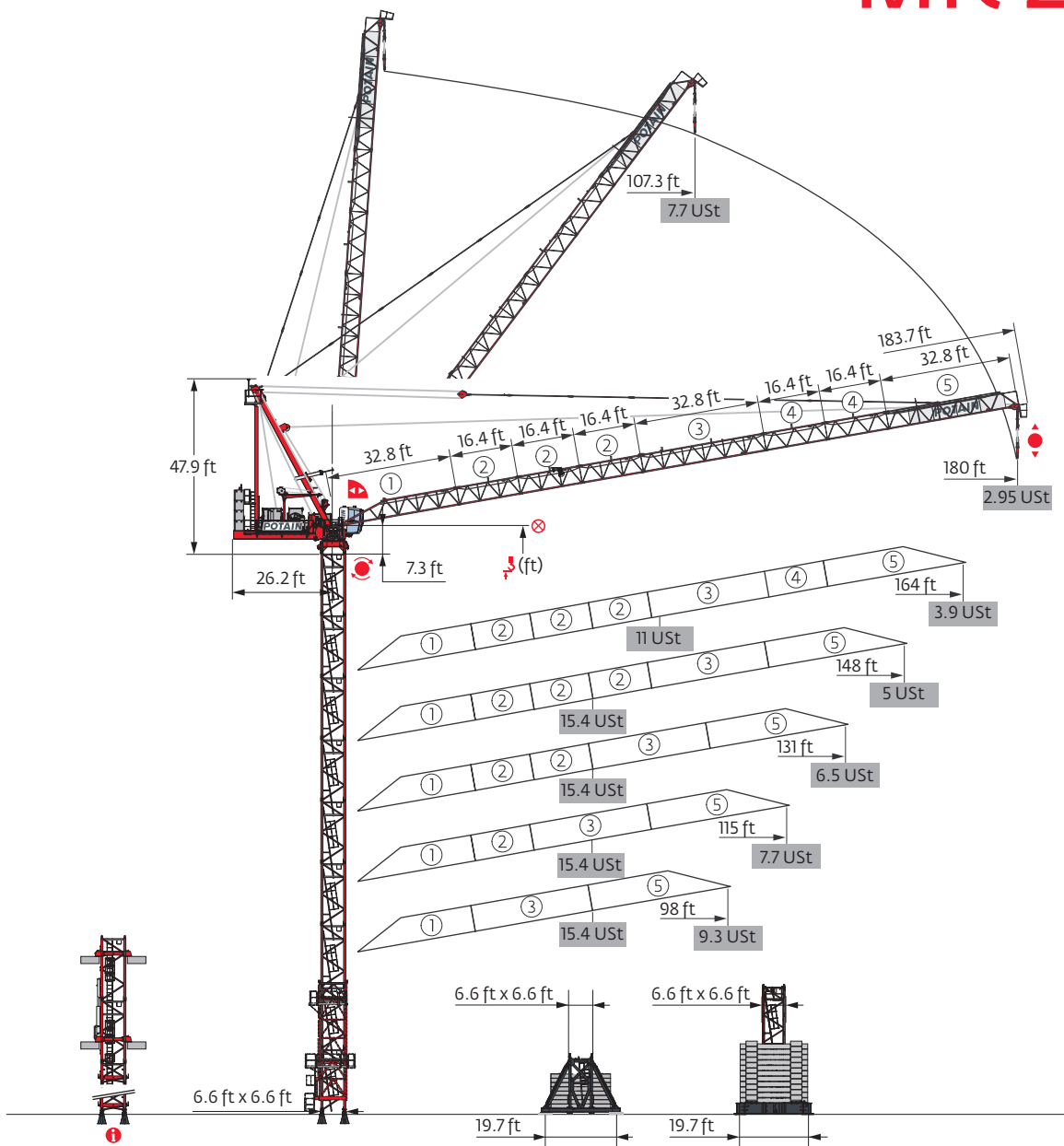

Potain Plus



Power Control

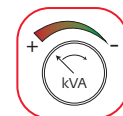

Top Tracing 3

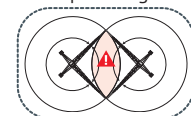

Mast - Reactions

6.6 ft - P 63A

Height (ft)	98	115	131	148	164	180
\downarrow (ft)	216.2	205.1	199.8	188.7	183.4	177.8
\downarrow/P_x (ft)	216.2	205.1	199.8	188.7	183.4	177.8
10.9 ft	1	0	1	0	1	2
16.4 ft	10	10	9	9	8	7
32.8 ft	1	1	1	1	1	1
F2 (Ust)	● 211 ■ 405	208 397	210 406	210 397	206 406	207 416
F3 (Ust)	● 164 ■ 359	162 352	158 361	159 354	161 363	162 372

6.6 ft - V 60A - 

Height (ft)	98	115	131	148	164	180
\downarrow (ft)	164.4	153.5	142.7	131.6	126.3	115.2
\downarrow/P_x (ft)	164.4	153.5	142.7	131.6	126.3	115.2
10.9 ft	1	0	2	1	2	1
16.4 ft	8	8	6	6	5	5
F1 (Ust)	● 107 ■ 132	107 128	108 125	108 122	105 127	103 123

6.6 ft - ZX 640 - 

Height (ft)	98	115	131	148	164	180
\downarrow (ft)	213.9	202.8	191.9	181.1	170	159.1
\downarrow/P_x (ft)	213.9	202.8	191.9	181.1	170	159.1
10.9 ft	2	1	0	2	1	0
16.4 ft	9	9	9	7	7	7
32.8 ft	1	1	1	1	1	1
F1 (Ust)	● 145 ■ 206	145 201	145 197	145 194	141 189	136 184

When "ASCE" is noted in this data sheet it is referring to 115 mph Wind Zone, Exposure B, Design Wind Speed = 98 mph. See back cover for design wind speed calculations.

i Other mast compositions - Please consult us.

Motorized accesses: adapted mast composition, base ballast and reactions.

P 63A / P 800B

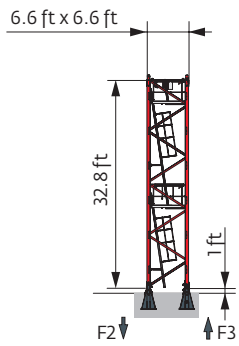

V 60A

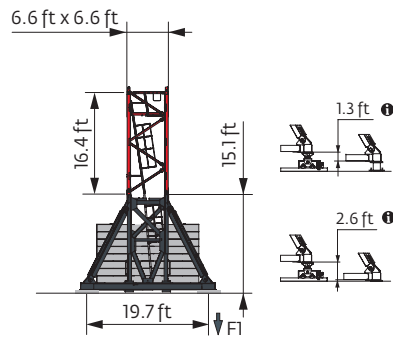

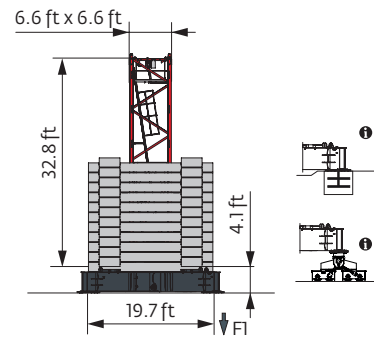

ZX 640





Anchorage



Base ballast

 (USt) /  6.6 ft - V60A - 

RAIL (ft)	98	115	131	148	164	180
164.4	145.5					
153.5	119.1	145.5				
142.7	119.1	119.1	145.5			
131.6	105.8	105.8	119.1	145.5		
126.3	105.8	105.8	119.1	132.3	145.5	
115.2	92.6	105.8	105.8	119.1	132.3	145.5
98.8	79.4	92.6	92.6	105.8	105.8	119.1
82.4	79.4	79.4	79.4	92.6	92.6	105.8
65.9	66.1	66.1	79.4	79.4	79.4	92.6



 (USt) /  6.6 ft - ZX 640 - 

RAIL (ft)	98	115	131	148	164	180
213.9	242.5					
202.8	220.5	242.5				
191.9	198.4	220.5	242.5			
181.1	165.4	198.4	220.5	242.5		
170	143.3	165.4	187.4	209.4	242.5	
159.1	121.3	143.3	165.4	187.4	209.4	231.5
142.7	110.2	121.3	132.3	154.3	176.4	198.4
126.3	99.2	99.2	110.2	121.3	132.3	154.3
109.9	88.2	88.2	99.2	99.2	110.2	121.3
93.5	77.2	77.2	88.2	88.2	99.2	110.2
77.1	66.1	66.1	77.2	77.2	88.2	88.2
60.7	55.1	55.1	66.1	66.1	77.2	77.2

Load curves







RAIL (ft)	56	66	72	82	89	98	99.4	105	115	115.6	121	131	131.7	138	147.6	147.9	154	164	ft	
164	13.1 → 82.5	104.2 - 108.3	11	11	11	10	8.5	-	7.7	7	-	6.4	5.5	-	5	4.4	-	4	3.5	USt
	13.1 → 83.8	106.5 - 111.5	11	11	11	10.2	8.8	-	7.9	7.3	-	6.7	5.8	-	5.3	4.6	-	4.2	3.6	USt P+
148	12.1 → 65.6	105.9 - 108.7	15.4	15.4	13.6	11.4	10.2	8.7	-	7.8	7.1	-	6.5	5.7	-	5.2	4.5	4.5	USt	
	12.1 → 65.6	108.2 - 112.1	15.4	15.4	13.7	11.6	10.4	8.9	-	8.1	7.5	-	6.8	6	-	5.5	4.8	4.7	USt P+	
131	10.8 → 65.9	106.9 - 111.5	15.4	15.4	13.8	11.6	10.4	8.8	-	8	7.3	-	6.7	5.9	5.8	USt				
	10.8 → 66	109.4 - 114.8	15.4	15.4	13.9	11.7	10.5	9.1	-	8.3	7.7	-	7.1	6.2	6.1	USt P+				
115	9.8 → 66.5	108.9 - 112.2	15.4	15.4	14	11.7	10.5	9	-	8.2	7.5	7.4	USt							
	9.8 → 66.6	111.4 - 115.6	15.4	15.4	14	11.9	10.7	9.3	-	8.4	7.7	7.7	USt P+							
98	8.5 → 66.4		15.4	15.4	14	11.8	10.6	9.1	8.9	USt										
	8.5 → 66.5		15.4	15.4	14	11.9	10.7	9.3	9.2	USt P+										

 =  - 0.51 USt max.



RAIL (ft)	56	66	72	82	89	98	99.4	105	115	115.6	121	131	131.7	138	147.6	147.9	154	164	171	180	ft
180	14.4 → 103.9	7.7	7.7	7.7	7.7	7.7	-	7.6	6.6	-	6.1	5.3	-	4.9	4.3	-	4	3.5	3.2	2.8	USt
	14.4 → 107.4	7.7	7.7	7.7	7.7	7.7	-	7.7	7	-	6.4	5.6	-	5.1	4.5	-	4.1	3.7	3.4	2.95	USt P+
164	13.1 → 109.6	7.7	7.7	7.7	7.7	7.7	-	7.7	7.2	-	6.6	5.8	-	5.3	4.7	-	4.3	3.7	USt		
	13.1 → 113.1	7.7	7.7	7.7	7.7	7.7	-	7.7	7.6	-	6.9	6.1	-	5.6	4.9	-	4.5	3.9	USt P+		
148	12.1 → 111.5	7.7	7.7	7.7	7.7	7.7	-	7.7	7.4	-	6.8	5.9	-	5.5	4.8	4.8	USt				
	12.1 → 114.8	7.7	7.7	7.7	7.7	7.7	-	7.7	7.7	-	7.1	6.2	-	5.7	5.1	5	USt P+				
131	10.8 → 113.3	7.7	7.7	7.7	7.7	7.7	-	7.7	7.6	-	7	6.2	6.1	USt							
	10.8 → 117.2	7.7	7.7	7.7	7.7	7.7	-	7.7	7.7	-	7.3	6.5	6.4	USt P+							
115	9.8 → 115.6	7.7	7.7	7.7	7.7	7.7	-	7.7	7.7	7.7	USt										
	9.8 → 115.6	7.7	7.7	7.7	7.7	7.7	-	7.7	7.7	7.7	USt P+										
98	8.5 → 99.4	7.7	7.7	7.7	7.7	7.7	7.7	USt													
	8.5 → 99.4	7.7	7.7	7.7	7.7	7.7	7.7	USt P+													

Jib weight & counter-jib ballast

	 (lb) (+/- 5%)		
		9,237 lb	 (lb)
180 ft	14,661 (lb)	4	36,949
164 ft	14,407	4	36,949
148 ft	13,536	4	36,949
131 ft	12,125	4	36,949
115 ft	10,714	4	36,949
98 ft	9,480	4	36,949

CAA - 9,237 lb

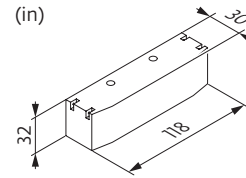



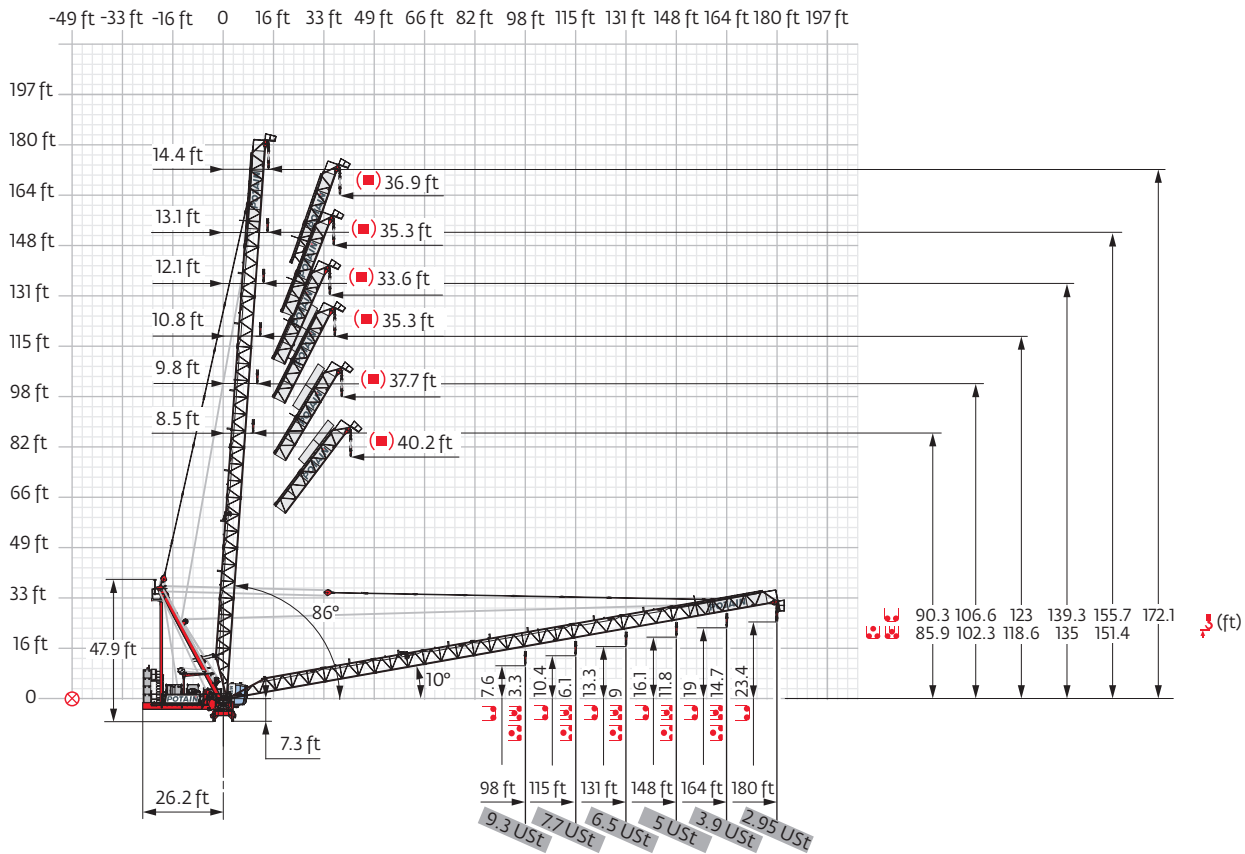

Luffing jib





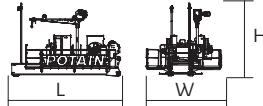
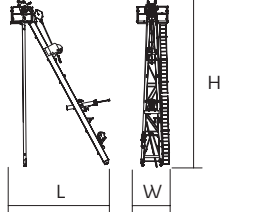
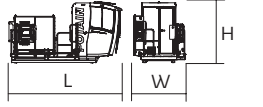
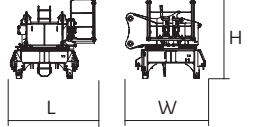
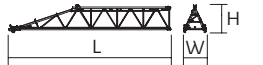

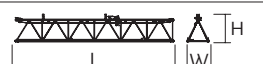
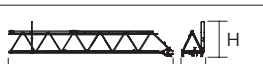
Dimensions and weight

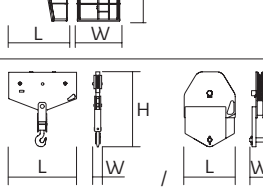
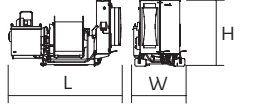
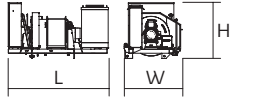
Slewing crane part:  180 ft -  90 HPL™

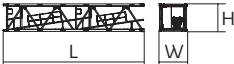

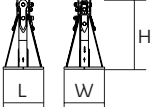
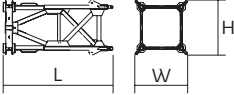
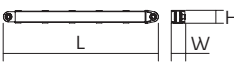
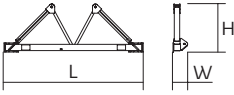
Slewing crane part		L (ft)	W (ft)	H (ft)	lb (+/- 5%)	
Counter-jib		90 HPL™ 132 HPL™	21.9 21.9	15.1 15.1	14.4 14.4	26,015 31,306
Strut			22.8	8.3	38.5	9,866
Cab		Ultra View	15.1	7	8.3	4,277
Towerhead		□ 6.6 ft	10.1	9.4	9.1	16,204
Jib section		①	33.8	4.8	5.5	2,156
Jib section		② ④	16.9 16.9	4.5 4.6	5.8 5.7	1,127 836
Jib section		③	33.3	4.5	5.8	1,669
Jib section		⑤	34.9	4.9	7.5	2,222
Jib nose inspection platform			6.3	4.7	7	123
Pulley block			4.3 2	0.7 0.8	5.2 2.9	626 507
Hoisting winch (+ rope)		90 HPL™ 132 HPL™	9.3 11.9	4.3 5.6	5.6 6.3	6,510 11,536
Luffing winch (+ rope)		75 VVF	9.2	5.3	5.3	6,316

Crane tower			L (ft)	W (ft)	H (ft)	lb (+/- 5%)
T 61		□ 6.6 ft	35.5	13.6	14.7	21,385
K 649B KM 649E KRM 6410B		□ 6.6 ft	33.6 33.8 33.6	6.8 6.7 6.9	6.7 6.7 6.8	11,663 10,692 15,653
K 649A KMT 649A KR 649A KRMT 649A		□ 6.6 ft □ 6.6 ft □ 6.6 ft □ 6.6 ft	17.2 17.2 17.2 17.2	6.8 6.8 6.9 6.9	6.7 6.7 6.8 6.8	6,184 5,666 7,165 6,724
K 649C KMT 649C KRMT 649C		□ 6.6 ft □ 6.6 ft □ 6.6 ft	11.7 11.7 11.7	6.8 6.8 6.9	6.7 6.7 6.8	4,376 4,542 5,401
Fixing angles		P 63A / P 800B	2.5	2.5	4.2	1,025
Basic mast unit		V 60A	16.4	7.9	7.9	10,494
Struts		V 60A	14.8	1	1	1,036
Half-bearer		V 60A	22	2.3	7.6	4,057
1/2 Cross girder		ZX 640	14.3	3.3	5.1	7,319
Cross girder		ZX 640	30	3.9	5.1	15,168

Mechanisms

480 V - 60 Hz													hp	kW	
	90 HPL™ 35	fpm	161	212	308	448	651	79	103	153	225	325	90	66	2,474 ft
		USt	7.7	5.8	3.9	2	0.6	15.4	11.6	7.7	3.9	1.3			
	132 HPL™ 35	fpm	240	310	435	571	679	120	156	218	287	340	132	98	4,291 ft
		USt	7.7	5.8	3.9	1.9	1.1	15.4	11.6	7.7	3.9	2.4			
	75 VVF 30		2 min									75	55		
	RVF 162 Optima+	rpm	0 → 0.7									2 x 7.5	2 x 5.5		

IEC 60204-32	kVA	
480 V (+6% -10%) 60 Hz	90 HPL™ + 75 VVF: 146 → 80 kVA	
	132 HPL™ + 75 VVF: 179 → 96 kVA	

These mast combinations meet the EN 14439 and ASME B30.3-2016 specifications for “out of service” wind conditions, provided the illustrated wind speed matches required design wind speed for the location of the tower crane. The “out of service” design wind speed was determined in accordance with ASCE 7-10, Figure 26.5-1A. The wind velocity, used for this configuration was 98 mph (158 kph), which represents a nominal design 3-second wind gust at 33 ft (10 m) above ground for Exposure B category. A factor of 0.85 was applied to the 700-year ultimate design wind speed of 115 mph (185 kph), per ASCE 37-02, with the assumption that this crane is considered a temporary structure used during a construction period of 2 years or less.

- Standard equipment
- Options
- Potain Plus function: Plus load curves
- Hook heights with Plus load curves
- Reactions in service
- Reactions out of service
- Jib weight
- Total ballast weight
- Jib articulation axis
- Weather vaning position
- Lorry 44 ft
- Container High Cube 40 ft, and/or Flat Rack 20 ft
- Hoisting
- Luffing
- Slewing
- Travelling
- Required power
- Power Control Function: winch speeds adapted to the available power
- Consult us

This commercial document is not legally binding. For any technical information, please refer to the corresponding instructions.

