

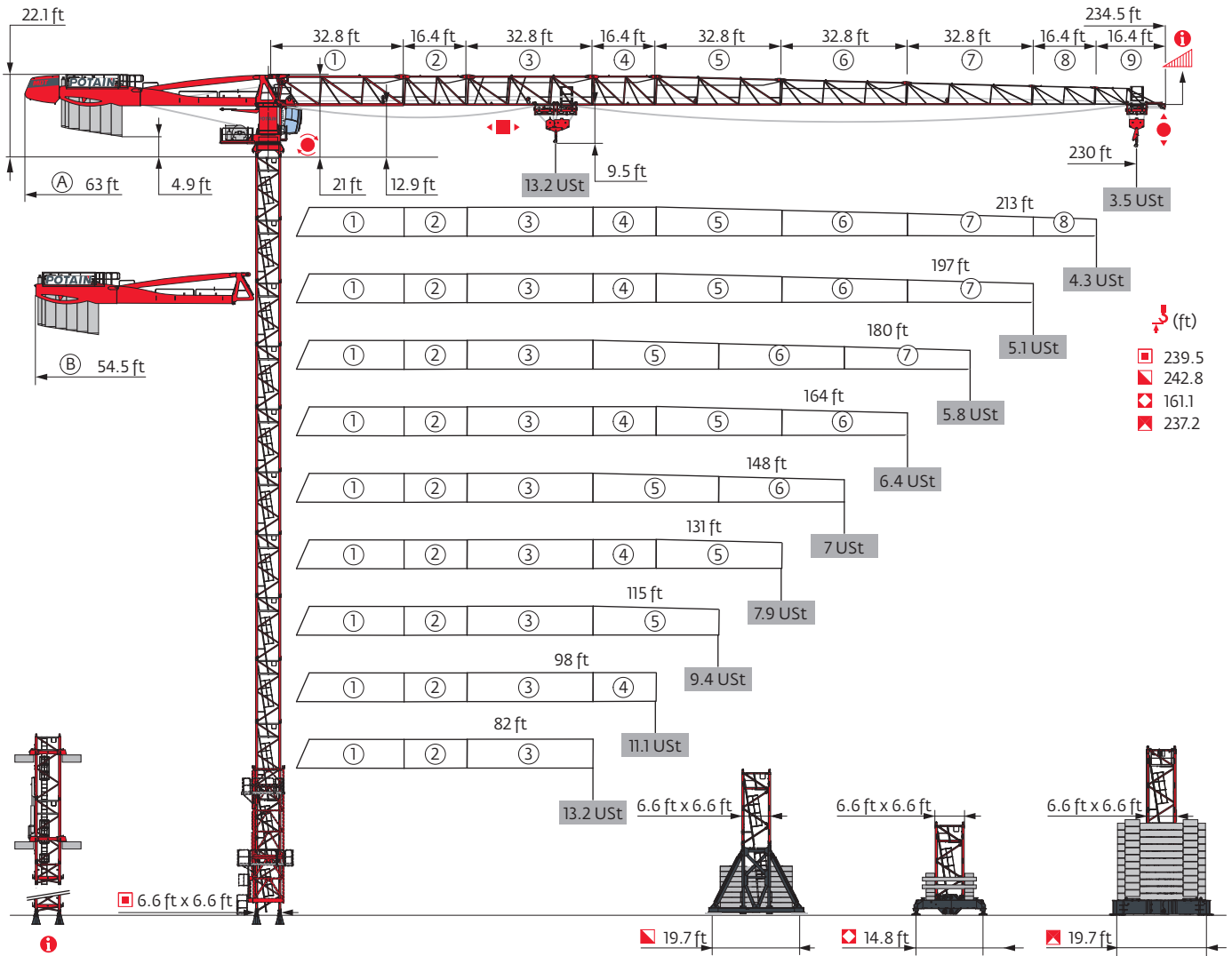

## MDT 319



Potain Plus    Power Control    Top Site    Top Tracing 3

Mast - Reactions



6.6 ft - P 63A										
Height (ft)	82	98	115	131	148	164	180	197	213	230
Height (ft)	239.5	233.9	233.9	233.9	228.7	228.7	228.7	228.7	217.5	217.5
Height/P <sub>+</sub> (ft)	239.5	233.9	233.9	233.9	228.7	228.7	228.7	228.7	217.5	217.5
Section	10.9 ft	2	0	0	0	1	1	1	1	0
	16.4 ft	11	12	12	12	11	11	11	11	11
	32.8 ft	1	1	1	1	1	1	1	1	1
F2 (USt)	● 216	218	217	222	217	218	218	220	217	219
	■ 341	330	329	336	319	327	328	326	300	308
F3 (USt)	● 159	159	158	161	156	155	156	155	153	155
	■ 290	278	276	281	264	271	272	267	244	251

6.6 ft - V 60A - 										
Height (ft)	82	98	115	131	148	164	180	197	213	230
Height (ft)	226	226	226	226	220.8	226	226	209.6	209.6	209.6
Height/P <sub>+</sub> (ft)	226	226	226	226	220.8	226	226	209.6	209.6	209.6
Section	10.9 ft	1	1	1	2	1	1	1	1	1
	16.4 ft	12	12	12	12	11	12	12	11	11
F1 (USt)	● 122	124	123	124	119	125	125	121	121	122
	■ 156	157	156	160	150	162	162	137	142	147

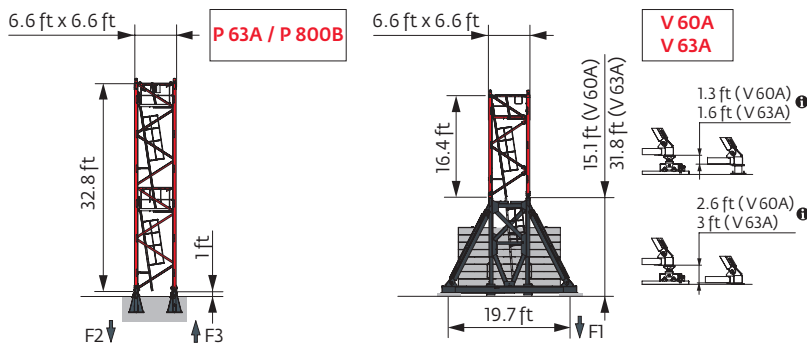

6.6 ft - V 63A - 										
Height (ft)	82	98	115	131	148	164	180	197	213	230
Height (ft)	237.2	242.8	242.8	242.8	237.2	237.2	237.2	220.8	226.4	226.4
Height/P <sub>+</sub> (ft)	237.2	242.8	242.8	242.8	237.2	237.2	237.2	220.8	226.4	226.4
Section	10.9 ft	2	1	1	1	2	2	2	1	1
	16.4 ft	11	12	12	12	11	11	10	11	11
F1 (USt)	● 136	140	140	141	136	136	136	128	131	135
	■ 176	186	185	188	178	182	183	156	169	174



**6.6 ft - ZD 463 - **

WAW (ft)	82	98	115	131	148	164	180	197	213	230
 (ft)	161.1	155.5	161.1	155.5	161.1	161.1	161.1	149.9	144.7	149.9
 / P <sub>r</sub> (ft)	161.1	155.5	161.1	155.5	161.1	161.1	161.1	149.9	144.7	149.9
	10.9 ft	2	0	2	0	2	2	2	1	2
	16.4 ft	8	9	8	9	8	8	8	8	7
FI (USt)	● 116	113	114	113	115	115	115	115	111	115
	■ 107	101	105	102	107	109	109	101	97	106

**6.6 ft - ZX 640 - **

WAW (ft)	82	98	115	131	148	164	180	197	213	230
 (ft)	237.2	237.2	237.2	237.2	231.6	231.6	231.6	231.6	220.8	220.8
 / P <sub>r</sub> (ft)	237.2	237.2	237.2	237.2	231.6	231.6	231.6	231.6	220.8	220.8
	10.9 ft	0	0	0	1	1	1	1	0	0
	16.4 ft	12	12	12	12	11	11	11	11	11
	32.8 ft	1	1	1	1	1	1	1	1	1
FI (USt)	● 130	134	134	136	131	132	132	134	132	133
	■ 170	173	172	176	166	170	171	169	156	160

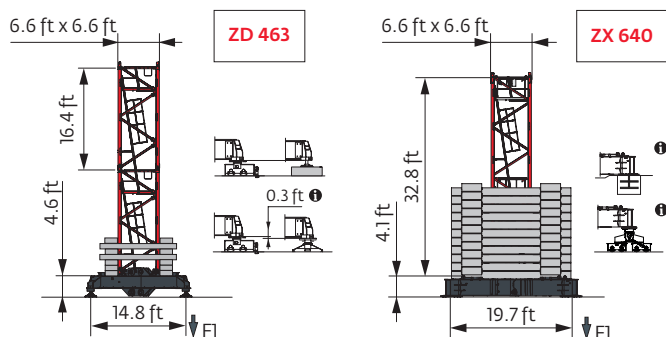

Note: When "ASCE" is noted in this data sheet it is referring to 115 mph Wind Zone, Exposure B, Design Wind Speed = 98 mph. See back cover for design wind speed calculations.

 Motorized accesses: adapted mast compositions, base ballast and reactions.

Other mast compositions - Please consult us

### Anchorage



Base ballast

**Ust / 6.6 ft - V 60A -**

Δ (ft)	82	98	115	131	148	164	180	197	213	230
226	145.5	145.5	145.5	145.5		145.5	145.5			
220.8	145.5	145.5	132.3	132.3	132.3	132.3	132.3			
209.6	132.3	119.1	119.1	119.1	119.1	119.1	119.1	132.3	132.3	132.3
193.2	105.8	105.8	105.8	105.8	105.8	92.6	92.6	105.8	105.8	105.8
176.8	92.6	92.6	92.6	79.4	92.6	79.4	79.4	92.6	92.6	92.6
160.4	79.4	79.4	79.4	66.1	66.1	66.1	66.1	79.4	79.4	79.4
144	66.1	66.1	66.1	52.9	52.9	52.9	52.9	66.1	66.1	66.1
127.6	52.9	52.9	52.9	52.9	52.9	52.9	52.9	52.9	39.7	52.9
111.2	52.9	52.9	52.9	52.9	52.9	52.9	52.9	52.9	39.7	52.9
94.8	52.9	52.9	52.9	52.9	52.9	52.9	52.9	52.9	39.7	39.7
78.4	52.9	52.9	52.9	52.9	52.9	52.9	52.9	52.9	39.7	39.7
62	52.9	52.9	52.9	52.9	52.9	52.9	52.9	52.9	39.7	39.7

**Ust / 6.6 ft - V 63A -**

Δ (ft)	82	98	115	131	148	164	180	197	213	230
242.8		185.2	185.2	185.2						
237.2	185.2	172	172	172	172	172	172			
226.4	158.7	158.7	145.5	145.5	145.5	145.5	158.7		145.5	158.7
220.8	145.5	145.5	145.5	145.5	132.3	145.5	145.5	145.5	145.5	145.5
204.4	119.1	119.1	119.1	119.1	119.1	105.8	105.8	119.1	119.1	119.1
188	105.8	105.8	105.8	92.6	105.8	92.6	92.6	105.8	105.8	105.8
171.6	92.6	92.6	92.6	79.4	79.4	79.4	79.4	92.6	92.6	92.6
155.2	79.4	79.4	66.1	66.1	66.1	66.1	66.1	79.4	66.1	66.1
138.8	66.1	66.1	52.9	52.9	52.9	52.9	52.9	52.9	52.9	52.9
122.4	52.9	52.9	52.9	52.9	52.9	52.9	52.9	39.7	39.7	52.9
106	52.9	52.9	52.9	52.9	52.9	52.9	52.9	39.7	39.7	52.9
89.6	52.9	52.9	52.9	52.9	52.9	52.9	52.9	39.7	39.7	39.7
73.2	52.9	52.9	52.9	52.9	52.9	52.9	52.9	39.7	39.7	39.7

**Ust / 6.6 ft - ZD 463 -**

Δ (ft)	82	98	115	131	148	164	180	197	213	230
161.1	137.8		126.8		126.8	121.3	121.3			
155.5	126.8	126.8	121.3	121.3	121.3	110.2	110.2			
149.9	121.3	115.7	115.7	115.7	110.2	104.7	104.7	121.3		115.7
144.7	115.7	110.2	110.2	110.2	104.7	99.2	99.2	115.7	110.2	110.2
128.3	93.7	99.2	93.7	99.2	93.7	88.2	88.2	93.7	88.2	88.2
111.9	88.2	93.7	93.7	93.7	88.2	88.2	88.2	82.7	77.2	82.7
95.5	88.2	93.7	93.7	93.7	88.2	88.2	88.2	82.7	77.2	82.7
79.1	88.2	93.7	93.7	93.7	88.2	88.2	88.2	82.7	77.2	77.2

**Ust / 6.6 ft - ZX 640 -**

Δ (ft)	82	98	115	131	148	164	180	197	213	230
237.2	165.4	165.4	165.4	165.4						
231.6	154.3	154.3	154.3	154.3	154.3	154.3	154.3	154.3		
220.8	143.3	143.3	143.3	143.3	143.3	143.3	143.3	143.3	154.3	154.3
204.4	121.3	121.3	121.3	121.3	121.3	121.3	121.3	121.3	132.3	132.3
188	110.2	110.2	110.2	110.2	110.2	99.2	99.2	99.2	110.2	110.2
171.6	88.2	88.2	88.2	88.2	88.2	88.2	88.2	88.2	88.2	88.2
155.2	77.2	77.2	77.2	66.1	77.2	66.1	66.1	66.1	77.2	77.2
138.8	55.1	55.1	55.1	55.1	55.1	55.1	55.1	55.1	55.1	55.1
122.4	44.1	55.1	55.1	55.1	55.1	44.1	44.1	44.1	44.1	44.1
106	44.1	55.1	55.1	55.1	55.1	44.1	44.1	44.1	44.1	44.1
89.6	44.1	55.1	55.1	55.1	55.1	44.1	44.1	44.1	44.1	44.1
73.2	44.1	55.1	55.1	55.1	55.1	44.1	44.1	44.1	44.1	44.1

Load curves



SPAN	(ft)		72	82	89	98	105	115	121	131	138	148	154	164	171	180	187	197	203	213	220	230	ft	
	USt	6.6 USt	USt									USt												
230	10 → 74	136 - 148	13.2	11.8	10.9	9.7	9	8.1	7.6	6.9	6.6	6.6	6.4	5.8	5.5	5	4.7	4.3	4.1	3.8	3.6	3.3	USt	
	10 → 75	137 - 148	13.2	11.9	10.9	9.7	9	8.1	7.6	6.9	6.6	6.6	6.4	5.9	5.7	5.3	5	4.6	4.3	4	3.8	3.5	USt P+	
213	10 → 78	144 - 155	13.2	12.5	11.5	10.2	9.5	8.6	8.1	7.4	7	6.6	6.6	6.1	5.7	5.2	4.9	4.5	4.3	4	USt			
	10 → 78	144 - 155	13.2	12.5	11.5	10.2	9.5	8.6	8.1	7.4	7	6.6	6.6	6.2	6	5.5	5.2	4.8	4.6	4.3	USt P+			
197	10 → 82	152 - 164	13.2	13.2	12.2	10.9	10.1	9.2	8.6	7.9	7.4	6.9	6.6	6.5	6.1	5.6	5.3	4.9	USt					
	10 → 82	153 - 164	13.2	13.2	12.2	10.9	10.1	9.2	8.6	7.9	7.4	6.9	6.6	6.6	6.3	5.9	5.5	5.1	USt P+					
180	10 → 80	148 - 159	13.2	12.9	11.9	10.6	9.8	8.9	8.3	7.6	7.2	6.7	6.6	6.4	6.1	5.8	USt							
	10 → 80	148 - 159	13.2	12.9	11.9	10.6	9.8	8.9	8.3	7.6	7.2	6.7	6.6	6.4	6.1	5.8	USt P+							
164	10 → 81	149 - 161	13.2	13	11.9	10.6	9.9	8.9	8.4	7.7	7.3	6.7	6.6	6.4	USt									
	10 → 81	149 - 161	13.2	13	11.9	10.6	9.9	8.9	8.4	7.7	7.3	6.7	6.6	6.4	USt P+									
148	10 → 84		13.2	13.2	12.4	11	10.3	9.3	8.7	8	7.6	7	USt											
	10 → 84		13.2	13.2	12.4	11	10.3	9.3	8.7	8	7.6	7	USt P+											
131	10 → 84		13.2	13.2	12.4	11	10.2	9.2	8.6	7.9	USt													
	10 → 84		13.2	13.2	12.4	11	10.2	9.2	8.6	7.9	USt P+													
115	10 → 84		13.2	13.2	12.5	11.1	10.3	9.3	USt															
	10 → 84		13.2	13.2	12.5	11.1	10.3	9.3	USt P+															
98	10 → 84		13.2	13.2	12.5	11.1	USt																	
	10 → 84		13.2	13.2	12.5	11.1	USt P+																	
82	10 → 82		13.2	13.2	USt																			
	10 → 82		13.2	13.2	USt P+																			

$W = W - 0.72 \text{ USt max.}$



SPAN	(ft)		72	82	89	98	105	115	121	131	138	148	154	164	171	180	187	197	203	213	220	230	ft	
	USt	6.6 USt	USt									USt												
230	8 → 74	137 - 139	13.2	11.9	11	9.7	9.1	8.2	7.7	7	6.6	6.2	5.9	5.4	5	4.5	4.2	3.8	3.6	3.3	3.1	2.9	USt	
	8 → 75	138 - 140	13.2	11.9	11	9.7	9	8.2	7.7	7	6.6	6.2	5.9	5.5	5.2	4.8	4.5	4.2	3.9	3.6	3.4	3.1	USt P+	
213	8 → 78	145 - 148	13.2	12.6	11.6	10.3	9.6	8.7	8.1	7.4	7	6.6	6.3	5.7	5.3	4.8	4.5	4.1	3.9	3.6	USt			
	8 → 78	145 - 148	13.2	12.6	11.6	10.3	9.6	8.6	8.1	7.4	7	6.6	6.3	5.8	5.6	5.1	4.8	4.4	4.2	3.9	USt P+			
197	8 → 83	153 - 157	13.2	13.2	12.3	10.9	10.2	9.2	8.7	7.9	7.5	6.9	6.6	6.2	5.8	5.2	4.9	4.5	USt					
	8 → 83	154 - 157	13.2	13.2	12.3	11	10.2	9.2	8.7	7.9	7.5	6.9	6.6	6.3	6	5.5	5.2	4.8	USt P+					
180	8 → 81	150 - 152	13.2	13	11.9	10.6	9.9	8.9	8.4	7.7	7.3	6.7	6.5	6.1	5.8	5.4	USt							
	8 → 81	150 - 152	13.2	13	11.9	10.6	9.9	8.9	8.4	7.7	7.3	6.7	6.5	6.1	5.8	5.4	USt P+							
164	8 → 81	151 - 154	13.2	13.1	12	10.7	10	9	8.5	7.7	7.3	6.8	6.6	6.1	USt									
	8 → 81	151 - 154	13.2	13.1	12	10.7	10	9	8.5	7.7	7.3	6.8	6.6	6.1	USt P+									
148	8 → 84		13.2	13.2	12.5	11.1	10.3	9.4	8.8	8.1	7.6	7	USt											
	8 → 84		13.2	13.2	12.5	11.1	10.3	9.4	8.8	8.1	7.6	7	USt P+											
131	8 → 84		13.2	13.2	12.5	11.1	10.3	9.3	8.7	7.9	USt													
	8 → 84		13.2	13.2	12.5	11.1	10.3	9.3	8.7	7.9	USt P+													
115	8 → 85		13.2	13.2	12.5	11.1	10.4	9.4	USt															
	8 → 85		13.2	13.2	12.5	11.1	10.4	9.4	USt P+															
98	8 → 85		13.2	13.2	12.6	11.1	USt																	
	8 → 85		13.2	13.2	12.6	11.1	USt P+																	
82	8 → 82		13.2	13.2	USt																			
	8 → 82		13.2	13.2	USt P+																			

$W = W - 0.21 \text{ USt max.}$

Jib weight & counter-jib ballast

SPAN	W (lb) (+/- 5%)			CBS			CBU		
	W	W	W	10,141 lb	3,373 lb	W (lb)	6,768 lb	3,373 lb	W (lb)
230 ft	32,587	31,744	32,721	5	2	57,452	8	1	57,519
213 ft	31,916	31,140	32,117	5	2	57,452	8	1	57,519
197 ft	31,070	30,360	31,226	5	2	57,452	8	1	57,519
180 ft	29,211	28,501	29,368	5	0	50,706	7	1	50,750
164 ft	29,527	28,817	29,683	5	0	50,706	7	1	50,750
148 ft	27,902	27,192	28,058	4	2	47,311	7	0	47,377
131 ft	27,324	26,614	27,481	4	1	43,938	6	1	43,982
115 ft	25,536	24,826	25,693	4	0	40,565	6	0	40,609
98 ft	24,209	23,499	24,365	3	2	37,170	5	1	37,214
82 ft	22,192	21,482	22,348	3	1	33,797	5	0	33,841

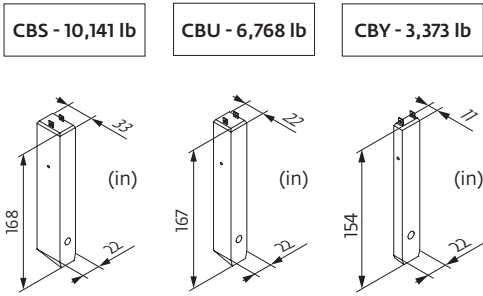

Dimensions and weight

Slewing crane part:  230 ft -  -  50 LVF



Slewing crane part		L (ft)	W (ft)	H (ft)	lb (+/- 5%)
Counter-jib		36.1 36.1	3.7 3.7	8.1 8.1	21,826 20,503
Cab mast + cab		16.1	7.3	8.2	13,228
Towerhead + Hoisting winch (+ rope)		17.3	8.3	9.2	21,054
Towerhead		9.7	8.1	8.2	13,228
Hoisting winch (+ rope)		14	7.5	7.6	9,921
Jib section		35.8	5.6	9	9,348
Jib section		33.8 33.5 33.6 33.4	3.9 3.9 3.9 3.9	7.9 7.8 6.9 6	5,335 3,439 2,723 1,753
Jib section		17.6 17.3 16.7 16.7	3.9 3.9 3.9 3.9	8 7.8 5 4.6	3,164 2,116 683 485
Trolley		6.1	5	3.4	882
Pulley block		3.9	1.4	7.6	1,003
Trolley		5.2	5	3.2	463
Trolley		5.6 6.1	5 5	3.4 3.2	540 520
Pulley block		5.4 3.6	0.7 0.9	5.8 5.3	992 584

Crane tower			L (ft)	W (ft)	H (ft)	lb (+/- 5%)
Telescopic cage T 61		□ 6.6 ft	35.5	13.6	14.7	21,385
K 649B KM 649E KRM 6410B		□ 6.6 ft	33.6 33.8 33.6	6.8 6.7 6.9	6.7 6.7 6.8	11,663 10,692 15,653
KR 649A KRMT 649A K 649A KMT 649A		□ 6.6 ft	17.2 17.2 17.2 17.2	6.9 6.9 6.8 6.8	6.8 6.8 6.7 6.7	7,165 6,724 6,184 5,666
K 649C KMT 649C KRMT 649C		□ 6.6 ft	11.7 11.7 11.7	6.8 6.8 6.9	6.7 6.7 6.8	4,376 4,542 5,401
Fixing angles		P 63A / P 800B	2.5	2.5	4.2	1,025
Basic mast unit		V 60A V 63A	16.4 32.9	7.9 7.9	7.9 7.9	10,494 16,887
Struts		V 60A V 63A	14.8 14.8	1 1.1	1 1.1	1,036 1,235
Half-bearer		V 60A V 63A	22 22	2.3 2.3	7.6 7.6	4,057 4,101
Cross girder		ZD 463	25.1	3.8	4.5	7,904
1/2 Cross girder		ZD 463	11.2	2.3	4.4	3,649
1/2 Cross girder		ZX 640	14.3	3.3	5.1	7,319
Cross girder		ZX 640	30	3.9	5.1	15,168

Mechanisms

480 V - 60 Hz											hp	kW			
	<b>50 LVF 30 Optima</b>	fpm	105	135	185	267	54	71	97	135	50	37	1,106 ft		
		USt	6.6	5	3.3	1.1	13.2	9.9	6.6	2.5					
	<b>90 HPL™ 30</b>	fpm	176	228	326	469	723	90	120	172	244	361	90	66	2,772 ft
		USt	6.6	5	3.3	1.7	0.2	13.2	9.9	6.6	3.3	0.9			
	<b>6 DVF 4 Optima</b>	fpm	0 → 164 (13.2 USt) 0 → 328 (6.6 USt) 0 → 394 (3.3 USt)								5.5	4			
	<b>RVF 162 Optima+</b>	rpm					0 → 0.9				2 x 7.5	2 x 5.5			

480 V (+6% -10%) 60 Hz	50 LVF: 58 → 38 kVA 90 HPL™: 90 → 54 kVA	

50 LVF 30 Optima

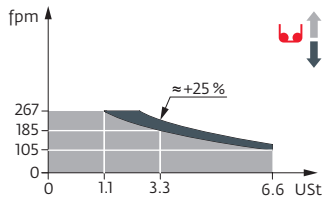

These mast combinations meet the EN 14439 and ASME B30.3-2016 specifications for “out of service” wind conditions, provided the illustrated wind speed matches required design wind speed for the location of the tower crane. The “out of service” design wind speed was determined in accordance with ASCE 7-10, Figure 26.5-1A. The wind velocity, used for this configuration was 98 mph (158 kph), which represents a nominal design 3-second wind gust at 33 ft (10 m) above ground for Exposure B category. A factor of 0.85 was applied to the 700-year ultimate design wind speed of 115 mph (185 kph), per ASCE 37-02, with the assumption that this crane is considered a temporary structure used during a construction period of 2 years or less.

- Jib elevation
- Total ballast weight
- Travelling
- Standard equipment
- Jib weight
- Required power
- Options
- Lorry 44 ft
- Power Control Function: wind speeds adapted to the available power
- Potain Plus function: Plus load curves
- Container High Cube 40 ft, and/or Flat Rack 20 ft
- Consult us
- Hook heights with Plus load curves
- Hoisting
- Reactions in service
- Trolleying
- Reactions out of service
- Slewing

This commercial document is not legally binding. For any technical information, please refer to the corresponding instructions.

