

## MDT 259 J12

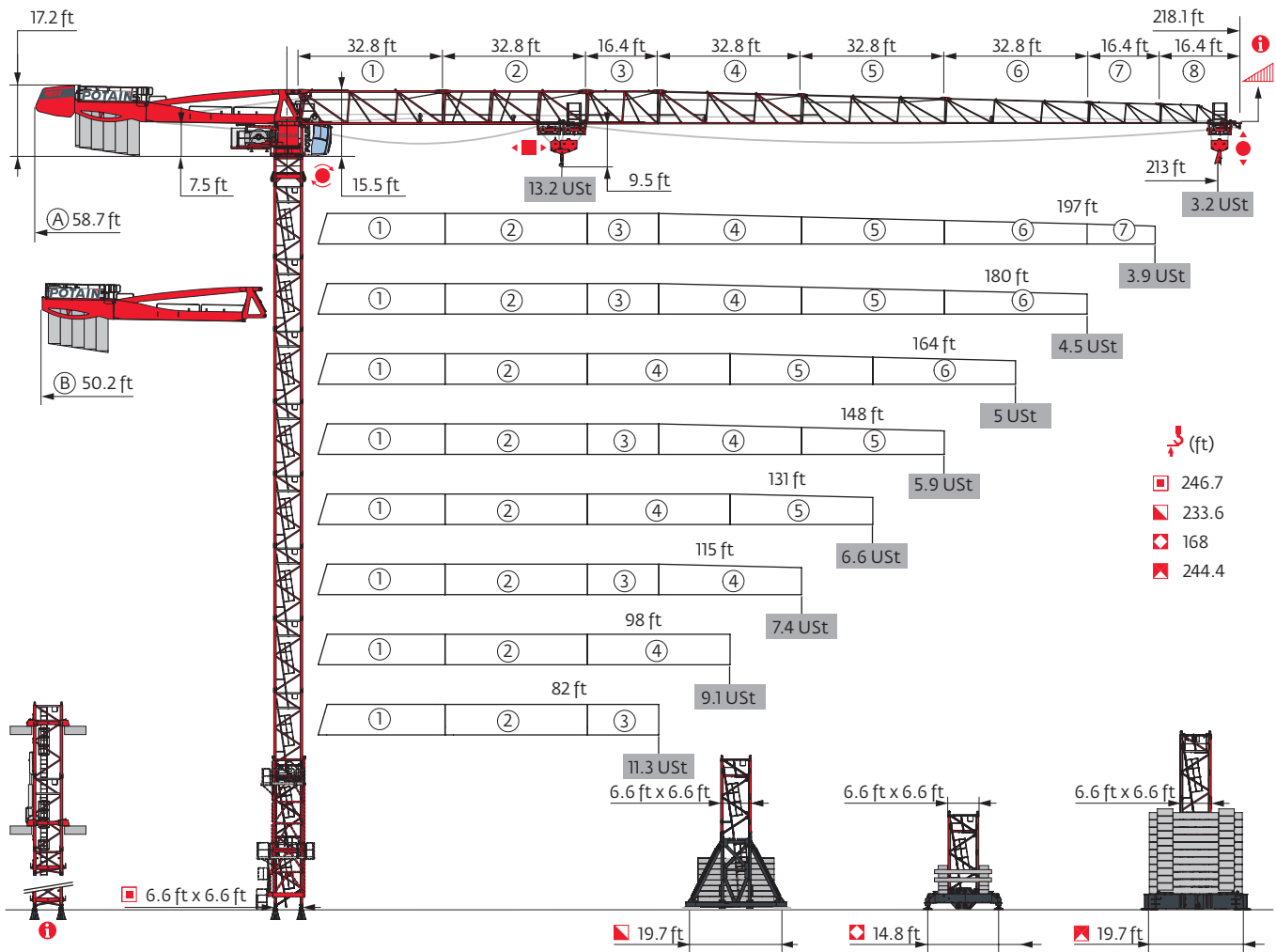

Potain Plus Power Control Top Site Top Tracing 3

The image shows four logos: Potain Plus (P+), Power Control (kVA), Top Site (a crane icon), and Top Tracing 3 (a crane icon with a red dot).

Mast - Reactions



6.6 ft - P 63A									
Height (ft)	82	98	115	131	148	164	180	197	213
$\bar{z}$ (ft)	246.7	241.1	235.6	235.6	235.6	235.6	235.6	224.7	224.7
$\bar{z}/P_r$ (ft)	246.7	241.1	235.6	235.6	235.6	235.6	235.6	224.7	224.7
6.6 ft	1	1	1	1	1	1	1	1	1
10.9 ft	1	2	0	0	0	0	0	2	2
16.4 ft	12	11	12	12	12	12	12	10	10
32.8 ft	1	1	1	1	1	1	1	1	1
F2 (USt)	● 219 ■ 386	213 371	212 359	212 356	213 364	213 365	212 362	208 331	209 338
F3 (USt)	● 164 ■ 338	158 323	156 310	155 306	155 313	155 314	152 310	148 278	149 284

6.6 ft - V 60A -									
Height (ft)	82	98	115	131	148	164	180	197	213
$\bar{z}$ (ft)	206	211.3	206	211.3	211.3	211.3	211.3	211.3	211.3
$\bar{z}/P_r$ (ft)	206	211.3	206	211.3	211.3	211.3	211.3	211.3	211.3
6.6 ft	1	1	1	1	1	1	1	1	1
10.9 ft	2	1	2	1	1	1	1	1	1
16.4 ft	10	11	10	11	11	11	11	11	11
F1 (USt)	● 113 ■ 145	114 152	114 147	115 152	115 156	115 157	119 155	119 154	119 158

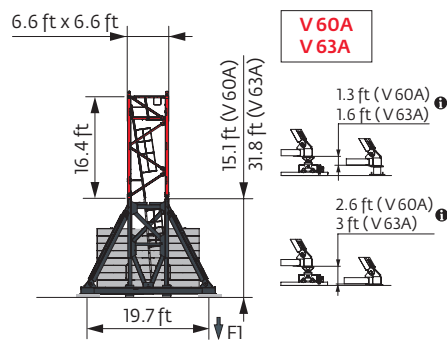
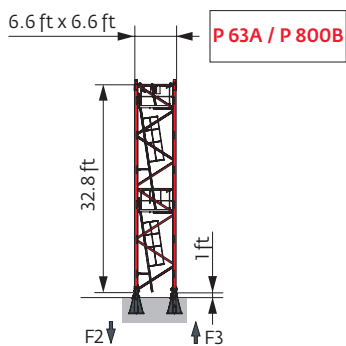

6.6 ft - V 63A -									
Height (ft)	82	98	115	131	148	164	180	197	213
$\bar{z}$ (ft)	228	233.6	233.6	233.6	233.6	233.6	233.6	228	228
$\bar{z}/P_r$ (ft)	228	233.6	233.6	233.6	233.6	233.6	233.6	228	228
6.6 ft	1	1	1	1	1	1	1	1	1
10.9 ft	1	0	0	0	0	0	0	1	1
16.4 ft	11	12	12	12	12	12	12	11	11
F1 (USt)	● 133 ■ 181	134 188	136 191	136 189	136 193	136 193	140 191	135 182	135 186



**6.6 ft - ZD 463 - **

WIND (ft)	82	98	115	131	148	164	180	197	213
 (ft)	168	168	168	168	168	168	162.7	162.7	162.7
 / P+ (ft)	168	168	168	168	168	168	162.7	162.7	157.2
	6.6 ft	1	1	1	1	1	1	1	1
	10.9 ft	1	1	1	1	1	2	2	2
	16.4 ft	9	9	9	9	9	8	8	8
Fl (Ust)	● 113	111	114	112	112	113	116	116	114
	■ 130	129	133	129	134	135	125	124	129

**6.6 ft - ZX 640 - **

WIND (ft)	82	98	115	131	148	164	180	197	213
 (ft)	244.4	244.4	244.4	238.9	238.9	238.9	238.9	228	228
 / P+ (ft)	244.4	244.4	244.4	238.9	238.9	238.9	238.9	228	228
	6.6 ft	1	1	1	1	1	1	1	1
	10.9 ft	2	2	2	0	0	0	2	2
	16.4 ft	11	11	11	12	12	12	10	10
	32.8 ft	1	1	1	1	1	1	1	1
Fl (Ust)	● 144	144	147	139	143	143	140	131	134
	■ 199	199	202	190	195	195	193	174	178

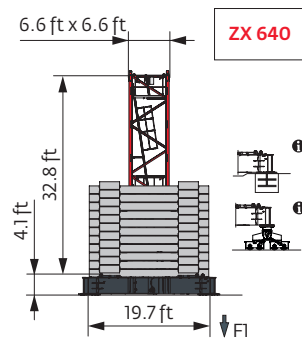
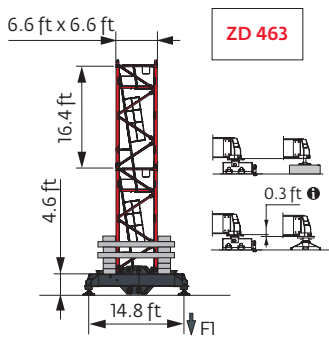

Note: When "ASCE" is noted in this data sheet it is referring to 115 mph Wind Zone, Exposure B, Design Wind Speed = 98 mph. See back cover for design wind speed calculations.

 Motorized accesses: adapted mast compositions, base ballast and reactions.

Other mast compositions - Please consult us

Anchorage



Lest de base

**Ust) / 6.6 ft - V 60A -**

Δ (ft)	82	98	115	131	148	164	180	197	213
211.3	145.5		145.5	145.5	145.5	145.5	145.5	145.5	145.5
206	145.5	145.5	145.5	132.3	145.5	145.5	132.3	132.3	132.3
189.6	105.8	105.8	105.8	105.8	105.8	105.8	105.8	105.8	105.8
173.2	79.4	79.4	79.4	79.4	79.4	79.4	92.6	92.6	92.6
156.8	66.1	66.1	66.1	66.1	66.1	66.1	66.1	66.1	66.1
140.4	52.9	52.9	52.9	52.9	52.9	52.9	52.9	52.9	52.9
124	39.7	39.7	39.7	39.7	39.7	39.7	39.7	39.7	39.7
107.6	39.7	39.7	39.7	39.7	26.5	26.5	26.5	26.5	26.5
91.2	39.7	39.7	39.7	39.7	26.5	26.5	26.5	26.5	26.5
74.8	39.7	39.7	39.7	39.7	26.5	26.5	26.5	26.5	26.5

**Ust) / 6.6 ft - V 63A -**

Δ (ft)	82	98	115	131	148	164	180	197	213
233.6	198.4		198.4	198.4	198.4	198.4	198.4	198.4	198.4
228	198.4	185.2	185.2	185.2	185.2	185.2	185.2	185.2	185.2
211.6	158.7	158.7	158.7	145.5	158.7	158.7	145.5	145.5	145.5
195.2	132.3	119.1	119.1	119.1	119.1	119.1	119.1	105.8	119.1
178.8	92.6	92.6	92.6	92.6	92.6	92.6	92.6	92.6	92.6
162.4	79.4	79.4	79.4	66.1	66.1	66.1	79.4	79.4	79.4
146	66.1	66.1	66.1	52.9	52.9	52.9	66.1	66.1	66.1
129.6	52.9	52.9	52.9	39.7	39.7	39.7	52.9	52.9	52.9
113.2	39.7	39.7	39.7	39.7	26.5	26.5	39.7	39.7	26.5
96.8	39.7	39.7	26.5	26.5	26.5	26.5	26.5	26.5	26.5
80.4	39.7	39.7	26.5	26.5	26.5	26.5	26.5	26.5	26.5

**Ust) / 6.6 ft - ZD 463 -**

Δ (ft)	82	98	115	131	148	164	180	197	213
168	132.3	126.8	132.3	126.8	121.3	126.8			
162.7	126.8	121.3	121.3	121.3	115.7	115.7	132.3	132.3	132.3
146.3	104.7	99.2	104.7	99.2	93.7	93.7	110.2	110.2	110.2
129.9	88.2	82.7	82.7	82.7	77.2	77.2	88.2	88.2	88.2
113.5	77.2	71.7	71.7	71.7	66.1	66.1	66.1	71.7	66.1
97.1	77.2	71.7	71.7	71.7	66.1	66.1	55.1	49.6	55.1
80.7	77.2	71.7	71.7	71.7	66.1	66.1	55.1	44.1	55.1
64.3	77.2	71.7	71.7	71.7	66.1	66.1	55.1	44.1	55.1

**Ust) / 6.6 ft - ZX 640 -**

Δ (ft)	82	98	115	131	148	164	180	197	213
244.4	220.5	220.5	220.5						
238.9	198.4	198.4	198.4	198.4	209.4	209.4	198.4		
228	176.4	176.4	176.4	165.4	176.4	176.4	176.4	165.4	176.4
211.6	143.3	132.3	143.3	132.3	143.3	143.3	132.3	143.3	143.3
195.2	110.2	110.2	110.2	110.2	110.2	110.2	110.2	121.3	121.3
178.8	99.2	88.2	99.2	99.2	88.2	88.2	88.2	99.2	99.2
162.4	77.2	77.2	77.2	77.2	77.2	77.2	77.2	77.2	77.2
146	66.1	66.1	66.1	66.1	55.1	55.1	55.1	66.1	66.1
129.6	44.1	44.1	44.1	44.1	44.1	44.1	44.1	44.1	44.1
113.2	44.1	33.1	33.1	33.1	33.1	33.1	22.1	33.1	33.1
96.8	44.1	33.1	33.1	33.1	33.1	33.1	22.1	22.1	22.1
80.4	44.1	33.1	33.1	33.1	33.1	33.1	22.1	22.1	22.1

Load curves



▽▽▽▽ (ft)		56	66	72	82	89	98	105	115	121	131	138	148	154	164	171	180	187	197	203	213	ft	
▽▽▽▽	▽▽▽▽ 13.2 USt	▽▽▽▽ 6.6 USt																					
213	10 → 57	101 - 109	13.2	11.2	10	8.6	7.8	6.8	6.6	6.3	5.9	5.4	5.1	4.7	4.4	4.1	3.9	3.7	3.5	3.3	3.1	2.95	USt
	10 → 61	109 - 118	13.2	12.3	11	9.4	8.6	7.5	7	6.6	6.4	5.9	5.5	5.1	4.8	4.5	4.3	4	3.8	3.6	3.4	3.2	USt P+
197	10 → 61	109 - 117	13.2	12.1	10.8	9.3	8.5	7.5	6.9	6.6	6.3	5.8	5.5	5.1	4.8	4.5	4.3	4	3.8	3.6		USt	
	10 → 66	118 - 127	13.2	13.2	11.9	10.3	9.4	8.2	7.6	6.8	6.6	6.4	6	5.5	5.3	4.9	4.7	4.3	4.2	3.9		USt P+	
180	10 → 62	112 - 120	13.2	12.4	11.1	9.6	8.8	7.7	7.1	6.6	6.5	6	5.6	5.2	5	4.6	4.4	4.1				USt	
	10 → 68	121 - 130	13.2	13.2	12.3	10.6	9.6	8.5	7.9	7	6.6	6.5	6.2	5.7	5.4	5	4.8	4.5				USt P+	
164	10 → 62	112 - 120	13.2	12.5	11.2	9.6	8.8	7.7	7.2	6.6	6.6	6	5.7	5.2	5	4.6						USt	
	10 → 68	121 - 131	13.2	13.2	12.3	10.6	9.7	8.5	7.9	7.1	6.6	6.6	6.2	5.7	5.4	5						USt P+	
148	10 → 64	114 - 123	13.2	12.8	11.4	9.9	9	7.9	7.3	6.6	6.6	6.1	5.8	5.4								USt	
	10 → 69	124 - 133	13.2	13.2	12.5	10.9	9.9	8.7	8.1	7.3	6.8	6.6	6.4	5.9								USt P+	
131	10 → 66	118 - 128	13.2	13.2	11.9	10.3	9.4	8.3	7.7	6.9	6.6	6.4										USt	
	10 → 71	128 - 131	13.2	13.2	13.1	11.3	10.3	9.1	8.4	7.6	7.1	6.6										USt P+	
115	10 → 64		13.2	12.9	11.5	9.9	9.1	8	7.4	6.6												USt	
	10 → 69		13.2	13.2	12.7	10.9	10	8.8	8.2	7.3												USt P+	
98	10 → 65		13.2	13.1	11.8	10.1	9.3	8.2														USt	
	10 → 71		13.2	13.2	12.9	11.2	10.2	9														USt P+	
82	10 → 65		13.2	13.2	11.8	10.2																USt	
	10 → 71		13.2	13.2	13	11.2																USt P+	

$W_{cr} = W_{cr} - 0.63 \text{ USt max.}$



▽▽▽▽ (ft)		56	66	72	82	89	98	105	115	121	131	138	148	154	164	171	180	187	197	203	213	ft	
▽▽▽▽	▽▽▽▽ 13.2 USt	▽▽▽▽ 6.6 USt																					
213	8 → 57	102 - 105	13.2	11.2	10	8.6	7.9	6.9	6.6	5.9	5.5	5	4.7	4.3	4.1	3.7	3.5	3.3	3.1	2.9	2.75	2.6	USt
	8 → 62	110 - 113	13.2	12.4	11.1	9.5	8.7	7.6	7	6.3	6	5.5	5.2	4.7	4.5	4.1	3.9	3.6	3.4	3.2	3.1	2.85	USt P+
197	8 → 61	110 - 112	13.2	12.2	10.9	9.4	8.6	7.6	7	6.4	6	5.5	5.2	4.7	4.5	4.1	3.9	3.7	3.5	3.3		USt	
	8 → 66	119 - 121	13.2	13.2	12	10.3	9.4	8.3	7.7	6.9	6.4	6	5.7	5.2	4.9	4.6	4.3	4	3.8	3.6		USt P+	
180	8 → 62	113 - 115	13.2	12.5	11.2	9.7	8.8	7.8	7.2	6.6	6.2	5.6	5.3	4.9	4.6	4.3	4.1	3.8				USt	
	8 → 68	122 - 124	13.2	13.2	12.3	10.6	9.7	8.6	7.9	7.1	6.6	6.2	5.8	5.4	5.1	4.7	4.5	4.2				USt P+	
164	8 → 63	113 - 115	13.2	12.5	11.2	9.7	8.9	7.8	7.2	6.6	6.2	5.7	5.3	4.9	4.6	4.3						USt	
	8 → 68	122 - 125	13.2	13.2	12.4	10.7	9.7	8.6	8	7.1	6.7	6.2	5.9	5.4	5.1	4.7						USt P+	
148	8 → 64	115 - 118	13.2	12.8	11.5	9.9	9.1	8	7.4	6.7	6.4	5.8	5.5	5								USt	
	8 → 69	125 - 127	13.2	13.2	12.6	10.9	10	8.8	8.2	7.3	6.8	6.3	6	5.5								USt P+	
131	8 → 66	119 - 122	13.2	13.2	12	10.3	9.4	8.3	7.7	6.9	6.6	6.1										USt	
	8 → 72	129 - 131	13.2	13.2	13.1	11.4	10.4	9.2	8.5	7.6	7.1	6.6										USt P+	
115	8 → 64		13.2	12.9	11.6	10	9.1	8.1	7.5	6.7												USt	
	8 → 70		13.2	13.2	12.7	11	10.1	8.9	8.2	7.4												USt P+	
98	8 → 66		13.2	13.2	11.8	10.2	9.3	8.2														USt	
	8 → 71		13.2	13.2	13	11.2	10.3	9.1														USt P+	
82	8 → 66		13.2	13.2	11.9	10.3																USt	
	8 → 71		13.2	13.2	13.1	11.3																USt P+	

$W_{cr} = W_{cr} - 0.18 \text{ USt max.}$

Jib weight & counter-jib ballast



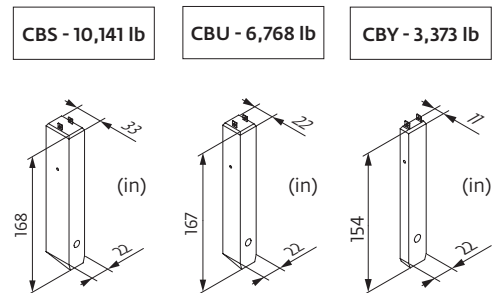

▽▽▽▽	▽▽▽▽ (lb) (+/- 5%)			▨▨▨▨		▨▨▨▨		▽▽▽▽ (lb)
	▽▽▽▽	▽▽▽▽	▽▽▽▽	10,141 lb	3,373 lb	6,768 lb	3,373 lb	
213 ft	27,761	26,985	27,961	5	1	54,079	7	54,123
197 ft	27,090	26,381	27,247	5	1	54,079	7	54,123
180 ft	26,420	25,710	26,577	5	0	50,706	7	50,750
164 ft	24,562	23,852	24,718	4	1	43,938	6	43,982
148 ft	24,877	24,167	25,033	4	1	43,938	6	43,982
131 ft	23,089	22,379	23,246	4	0	40,565	6	40,609
115 ft	22,824	22,115	22,981	3	2	37,170	5	37,214
98 ft	20,723	20,014	20,880	3	1	33,797	5	33,841
82 ft	19,557	18,847	19,714	3	0	30,424	4	30,446







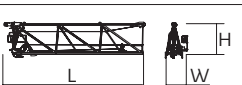
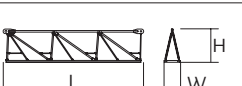
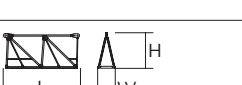
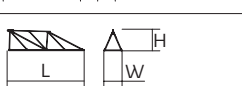
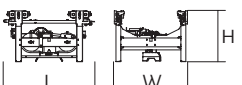
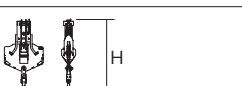
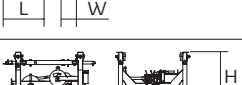

Dimensions and weight

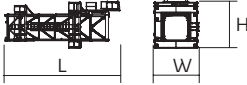
Slewing crane part:  213 ft -  50 LVF

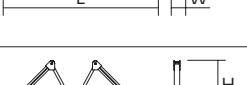
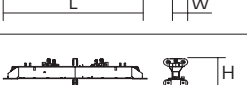

Slewing crane part		L (ft)	W (ft)	H (ft)	lb (+/- 5%)
Counter-jib		36.1 36.1	3.8 3.8	8.1 8.1	19,213 18,629
Towerhead + cab		16.1	7.5	8.3	18,618
Hoisting winch (+ rope)		10.6 10.6	8.1 10.8	6.2 5.8	6,945 9,235
Jib section		35.5	5.6	9	7,959
Jib section		33.8 33.5 33.6 33.4	3.9 3.9 3.9 3.9	7.9 7.8 6.9 6	5,335 3,439 2,723 1,753
Jib section		17.3 16.7	3.9 3.9	7.8 5	2,116 683
Jib section		16.7	3.9	4.6	485
Trolley		6.1	5	3.4	882
Pulley block		3.9	1.4	7.6	1,003
Trolley		5.2	5	3.2	463
Trolley		5.6 6.1	5 5	3.4 3.2	540 520
Pulley block		5.4 3.6	0.7 0.9	5.8 5.3	992 584

Crane tower		L (ft)	W (ft)	H (ft)	lb (+/- 5%)	
Telescopic cage T 61		6.6 ft	35.5	13.6	14.7	21,385
K60/K60-2		6.6 ft	7.3	8.2	8.1	4,255
K 649B KM 649E KRM 6410B		6.6 ft	33.6 33.8 33.6	6.8 6.7 6.9	6.7 6.7 6.8	11,663 10,692 15,653
K 649A KMT 649A KR 649A KRMT 649A		6.6 ft	17.2 17.2 17.2 17.2	6.8 6.8 6.9 6.9	6.7 6.7 6.8 6.8	6,184 5,666 7,165 6,724
K 649C KMT 649C KRMT 649C		6.6 ft	11.7 11.7 11.7	6.8 6.8 6.9	6.7 6.7 6.8	4,376 4,542 5,401
Fixing angles		P 63A / P 800B	2.5	2.5	4.2	1,025
Basic mast unit		V 60A V 63A	16.4 32.9	7.9 7.9	7.9 7.9	10,494 16,887
Struts		V 60A V 63A	14.8 14.8	1 1.1	1 1.1	1,036 1,235
Half-bearer		V 60A V 63A	22 22	2.3 2.3	7.6 7.6	4,057 4,101
Cross girder		ZD 463	25.1	3.8	4.5	7,904
1/2 Cross girder		ZD 463	11.2	2.3	4.4	3,649
1/2 Cross girder		ZX 640	14.3	3.3	5.1	7,319
Cross girder		ZX 640	30	3.9	5.1	15,168

Mechanisms

480 V - 60 Hz											hp	kW			
	50 LVF 30 Optima	fpm	105	135	185	267	54	71	97	135	50	37	1,106 ft		
		USt	6.6	5	3.3	1.1	13.2	9.9	6.6	2.5					
	90 HPL™ 30	fpm	176	228	326	469	723	90	120	172	244	361	90	66	2,434 ft
		USt	6.6	5	3.3	1.7	0.2	13.2	9.9	6.6	3.3	0.9			
	6 DVF 4 Optima	fpm	0 → 164 (13.2 USt) 0 → 328 (6.6 USt) 0 → 394 (3.3 USt)								5.5	4			
	RVF 162 Optima+	rpm					0 → 0.9				2 x 7.5	2 x 5.5			

	IEC 60204-32		kVA
480 V (+6% -10%) 60 Hz		50 LVF: 58 → 38 kVA 90 HPL™: 90 → 54 kVA	

50 LVF 30 Optima

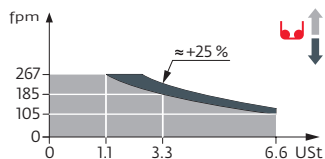

These mast combinations meet the EN 14439 and ASME B30.3-2016 specifications for “out of service” wind conditions, provided the illustrated wind speed matches required design wind speed for the location of the tower crane. The “out of service” design wind speed was determined in accordance with ASCE 7-10, Figure 26.5-1A. The wind velocity, used for this configuration was 98 mph (158 kph), which represents a nominal design 3-second wind gust at 33 ft (10 m) above ground for Exposure B category. A factor of 0.85 was applied to the 700-year ultimate design wind speed of 115 mph (185 kph), per ASCE 37-02, with the assumption that this crane is considered a temporary structure used during a construction period of 2 years or less.

- Jib elevation
- Standard equipment
- Options
- Potain Plus function: Plus load curves
- Hook heights with Plus load curves
- Reactions in service
- Reactions out of service
- Total ballast weight
- Jib weight
- Lorry 44 ft
- Container High Cube 40 ft, and/or Flat Rack 20 ft
- Hoisting
- Trolleying
- Slewing
- Travelling
- Required power
- Power Control Function: winch speeds adapted to the available power
- Consult us

This commercial document is not legally binding. For any technical information, please refer to the corresponding instructions.

