

MD 689 M25

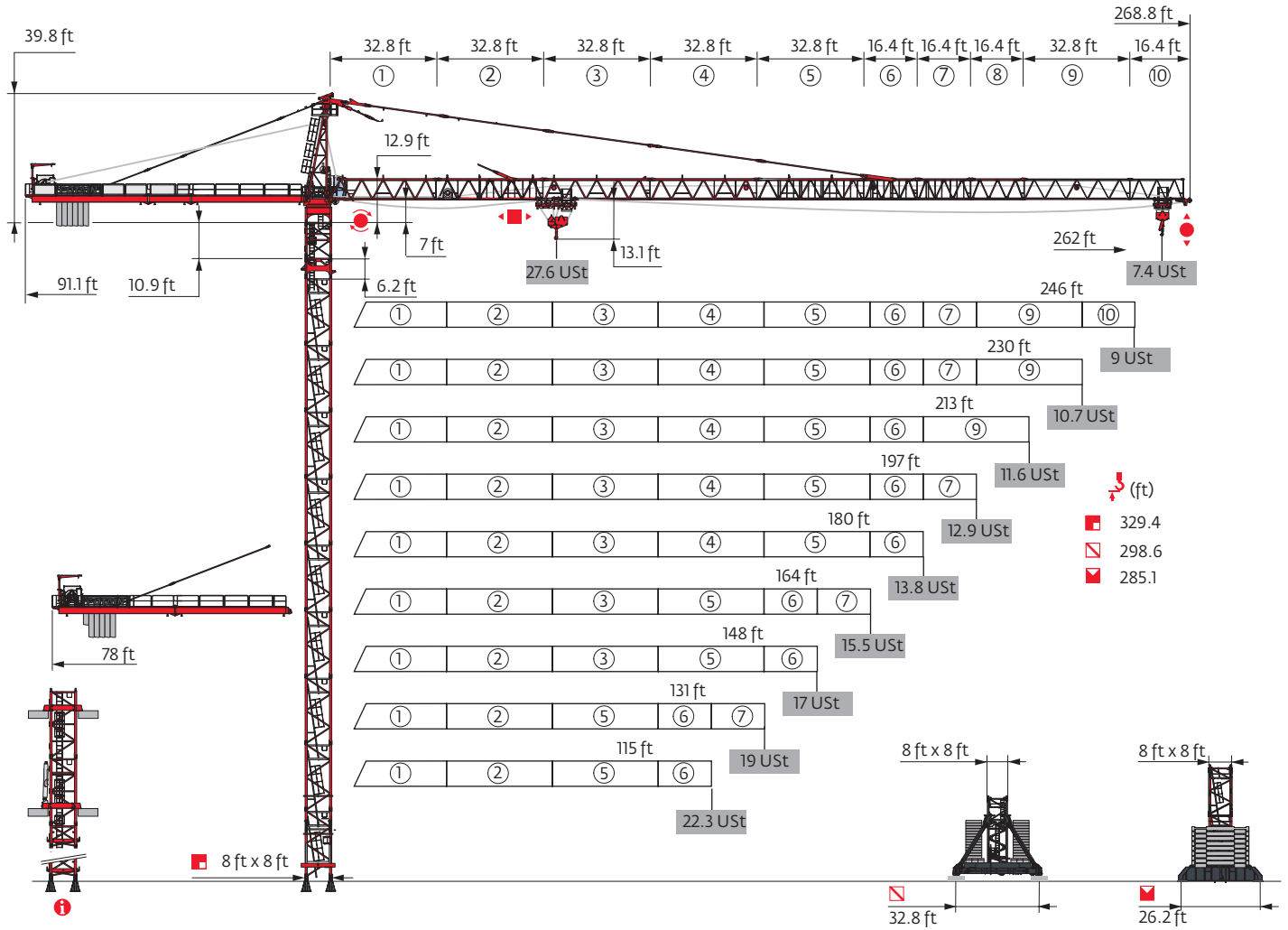

Potain Plus



Power Control

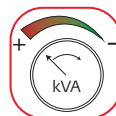

Top Site

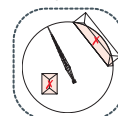

Top Tracing 3

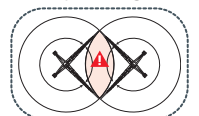

Mast - Reactions

8 ft - P 854A										
Height (ft)	115	131	148	164	180	197	213	230	246	262
Height (ft)	295.9	295.9	295.9	295.9	295.9	290.7	290.7	290.7	279.5	279.5
Height/P _r (ft)	295.9	295.9	295.9	295.9	295.9	290.7	290.7	290.7	279.5	279.5
10.9 ft	1	1	1	1	1	1	1	1	1	1
6.2 ft	1	1	1	1	1	1	1	1	1	1
10.9 ft	2	2	2	2	2	0	0	0	2	2
16.4 ft	16	16	16	16	16	17	17	17	15	15
F2 (Ust)	● 382	383	385	385	389	381	382	378	376	382
	■ 610	614	613	606	623	588	593	591	570	603
F3 (Ust)	● 266	265	264	261	266	258	258	252	251	256
	■ 508	510	506	496	513	478	482	479	460	491

8 ft - P 880A										
Height (ft)	115	131	148	164	180	197	213	230	246	262
Height (ft)	329.4	329.4	329.4	329.4	329.4	329.4	329.4	329.4	324.2	318.6
Height/P _r (ft)	329.4	329.4	329.4	329.4	329.4	329.4	329.4	329.4	324.2	318.6
10.9 ft	1	1	1	1	1	1	1	1	1	1
6.2 ft	1	1	1	1	1	1	1	1	1	1
10.9 ft	2	2	2	2	2	2	2	2	0	1
16.4 ft	18	18	18	18	18	18	18	18	19	18
F2 (Ust)	● 442	443	442	441	448	449	449	445	451	452
	■ 835	843	841	835	860	856	861	852	826	840
F3 (Ust)	● 309	306	302	299	305	302	302	298	307	306
	■ 715	720	716	707	730	724	728	719	695	708

8 ft - JM 850										
Height (ft)	115	131	148	164	180	197	213	230	246	262
Height (ft)	293	293	298.6	298.6	293	298.6	293	287.7	287.7	276.6
Height/P _r (ft)	287.7	282.2	282.2	282.2	276.6	271.3	276.6	282.2	276.6	271.3
10.9 ft	1	1	1	1	1	1	1	1	1	1
6.2 ft	1	1	1	1	1	1	1	1	1	1
10.9 ft	2	2	1	1	2	1	2	0	0	2
16.4 ft	14	14	15	15	14	15	14	15	15	13
F1 (Ust)	● 171	172	174	174	174	175	175	168	174	172
	■ 227	229	235	231	231	236	231	217	224	224

8 ft - ZY 854										
Height (ft)	115	131	148	164	180	197	213	230	246	262
Height (ft)	285.1	285.1	285.1	285.1	279.5	279.5	279.5	279.5	268.7	274
Height/P _r (ft)	285.1	285.1	285.1	285.1	279.5	279.5	279.5	279.5	268.7	274
10.9 ft	1	1	1	1	1	1	1	1	1	1
6.2 ft	1	1	1	1	1	1	1	1	1	1
10.9 ft	2	2	2	2	0	0	0	0	2	1
16.4 ft	15	15	15	15	16	16	16	16	14	15
F1 (Ust)	● 222	223	225	224	221	219	219	219	214	228
	■ 287	290	289	284	278	275	278	278	268	300

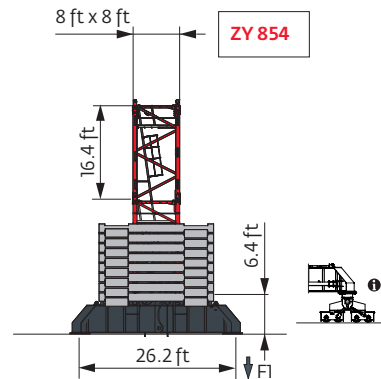
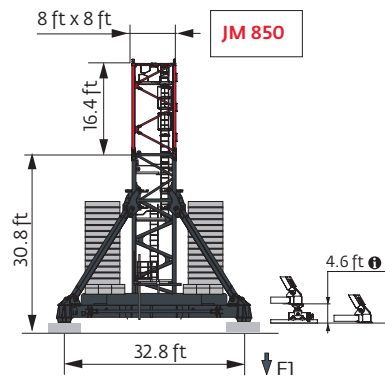
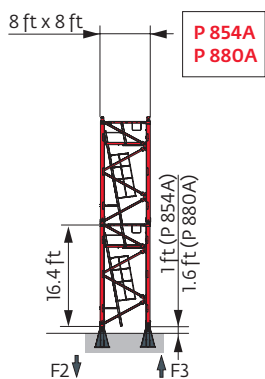

Other mast compositions - Please consult us.

Motorized accesses: adapted mast compositions, base ballast and reactions.

Note: When "ASCE" is noted in this data sheet it is referring to 115 mph Wind Zone, Exposure B, Design Wind Speed = 98 mph. See back cover for design wind speed calculations.

Anchorage



Base ballast

(Ust) / 8 ft - JM 850 -										
(ft)	115	131	148	164	180	197	213	230	246	262
298.6			132.3	132.3		132.3				
293	132.3	132.3	132.3	119.1	132.3	119.1	132.3			
287.7	119.1	119.1	105.8	92.6	105.8	105.8	105.8	105.8	119.1	
282.2	105.8	105.8	92.6	92.6	105.8	92.6	92.6	92.6	105.8	
276.6	92.6	92.6	92.6	79.4	92.6	79.4	79.4	79.4	92.6	119.1
260.2	79.4	79.4	66.1	66.1	66.1	66.1	52.9	52.9	66.1	79.4
243.8	66.1	52.9	52.9	52.9	52.9	52.9	52.9	52.9	52.9	52.9
227.4	52.9	52.9	52.9	52.9	52.9	52.9	52.9	52.9	52.9	52.9
(ft)	211	52.9	52.9	52.9	52.9	52.9	52.9	52.9	52.9	52.9
	194.6	52.9	52.9	52.9	52.9	52.9	52.9	52.9	52.9	52.9
178.2	52.9	52.9	52.9	52.9	52.9	52.9	52.9	52.9	52.9	52.9
161.8	52.9	52.9	52.9	52.9	52.9	52.9	52.9	52.9	52.9	52.9
145.3	52.9	52.9	52.9	52.9	52.9	52.9	52.9	52.9	52.9	52.9
128.9	52.9	52.9	52.9	52.9	52.9	52.9	52.9	52.9	52.9	52.9
112.5	52.9	52.9	52.9	52.9	52.9	52.9	52.9	52.9	52.9	52.9
96.1	52.9	52.9	52.9	52.9	52.9	52.9	52.9	52.9	52.9	52.9

(Ust) / 8 ft - ZY 854 -										
(ft)	115	131	148	164	180	197	213	230	246	262
285.1	198.4	198.4	198.4	185.2						
279.5	185.2	185.2	172	158.7	185.2	172	172	158.7		
274	172	172	158.7	145.5	158.7	158.7	158.7	158.7		198.4
268.7	158.7	158.7	145.5	145.5	145.5	145.5	145.5	132.3	158.7	185.2
252.3	119.1	119.1	119.1	119.1	119.1	119.1	119.1	105.8	119.1	132.3
235.9	105.8	105.8	105.8	105.8	105.8	105.8	105.8	92.6	92.6	92.6
219.5	92.6	92.6	92.6	92.6	92.6	92.6	92.6	79.4	79.4	79.4
(ft)	203.1	92.6	79.4	79.4	79.4	79.4	79.4	66.1	66.1	79.4
	186.7	79.4	79.4	79.4	79.4	79.4	79.4	66.1	66.1	79.4
170.3	79.4	79.4	79.4	79.4	79.4	79.4	79.4	66.1	66.1	79.4
153.9	79.4	79.4	79.4	79.4	79.4	79.4	79.4	66.1	66.1	79.4
137.5	79.4	79.4	79.4	79.4	79.4	79.4	79.4	66.1	66.1	79.4
121.1	79.4	79.4	79.4	79.4	79.4	79.4	79.4	66.1	66.1	79.4
104.7	79.4	79.4	79.4	79.4	79.4	79.4	79.4	66.1	66.1	79.4
88.3	79.4	79.4	79.4	79.4	79.4	79.4	79.4	66.1	66.1	79.4

Load curves



▼ (ft)		72	82	89	98	115	121	131	148	154	164	180	187	197	213	220	230	236	246	253	262	ft	
▼	▼ 27.6 USt	▼ → 13.8 USt	▼										▼										
262	12.5 → 77.4	136.8 - 149.6	27.6	25.7	23.5	20.7	17.2	16	14.5	13.8	13.3	12.4	11	10.6	9.9	9	8.7	8.2	7.9	7.5	7.3	6.9	USt
	12.5 → 78.8	141.2 - 154.7	27.6	26.3	24.1	21.3	17.7	16.6	15.1	13.8	13.8	12.9	11.6	11.1	10.4	9.5	9.1	8.7	8.4	8	7.7	7.4	USt P+
246	12.5 → 84.7	148.2 - 161.4	27.6	27.6	26.1	23	19	17.8	16.1	13.8	13.8	13.5	12	11.5	10.8	9.8	9.4	8.9	8.6	8.2			USt
	12.5 → 87.7	156.6 - 170.9	27.6	27.6	27	24.1	20.1	18.8	17.1	14.8	14	13.8	12.9	12.4	11.7	10.6	10.3	9.7	9.4	9			USt P+
230	12.5 → 90	158.9 - 172.7	27.6	27.6	27.6	24.8	20.6	19.3	17.5	15.1	14.3	13.8	13.1	12.5	11.8	10.7	10.3	9.8					USt
	12.5 → 92	167.7 - 182.9	27.6	27.6	27.6	25.5	21.5	20.2	18.4	16	15.2	14.2	13.8	13.5	12.7	11.6	11.2	10.7					USt P+
213	12.5 → 87.8	159.1 - 173.9	27.6	27.6	27	24.2	20.3	19	17.4	15.1	14.3	13.8	13.2	12.7	11.9	10.9							USt
	12.5 → 92.2	168.2 - 182.6	27.6	27.6	27.6	25.6	21.5	20.2	18.4	16.1	15.3	14.2	13.8	13.4	12.7	11.6							USt P+
197	12.5 → 88.7	160.6 - 175	27.6	27.6	27.6	24.5	20.5	19.2	17.6	15.3	14.5	13.8	13.3	12.8	12.1								USt
	12.5 → 93.6	170.8 - 185.4	27.6	27.6	27.6	26.1	21.9	20.6	18.8	16.4	15.6	14.5	13.8	13.7	12.9								USt P+
180	12.5 → 88.3	159.9 - 174.2	27.6	27.6	27	24.4	20.4	19.1	17.5	15.2	14.4	13.8	13.2										USt
	12.5 → 91.8	167.3 - 180.4	27.6	27.6	27.6	25.5	21.4	20.1	18.4	16	15.2	14.1	13.8	13.7									USt P+
164	12.5 → 91.5		27.6	27.6	27.6	25.4	21.3	20	18.2	15.9	15	14											USt
	12.5 → 96.2		27.6	27.6	27.6	26.8	22.6	21.2	19.4	16.9	16.1	14.9											USt P+
148	12.5 → 90.3		27.6	27.6	27.6	25	21	19.7	18	15.6													USt
	12.5 → 93.6		27.6	27.6	27.6	26	21.9	20.5	18.8	16.4													USt P+
131	12.5 → 90.3		27.6	27.6	27.6	25	21	19.7	17.9														USt
	12.5 → 92.1		27.6	27.6	27.6	25.6	21.5	20.2	18.4														USt P+
115	12.5 → 91		27.6	27.6	27.6	25.2	21.1																USt
	12.5 → 92.9		27.6	27.6	27.6	25.8	21.7																USt P+

$W_{1.5} = W_{1.0} - 1.51 \text{ USt max.}$



▼ (ft)		72	82	89	98	115	121	131	148	154	164	180	187	197	213	220	230	236	246	253	262	ft	
▼	▼ 27.6 USt	▼ → 13.8 USt	▼										▼										
262	8.9 → 78.8	141.3 - 144.8	27.6	26.3	24.1	21.3	17.7	16.6	15.1	13.5	12.8	11.8	10.5	10	9.4	8.5	8.1	7.7	7.4	7	6.7	6.4	USt
	8.9 → 80.2	146.1 - 149.7	27.6	26.9	24.7	21.9	18.3	17.2	15.7	13.8	13.3	12.4	11	10.6	9.9	9	8.6	8.1	7.9	7.4	7.2	6.8	USt P+
246	8.9 → 86.2	153.1 - 156.7	27.6	27.6	26.7	23.6	19.6	18.3	16.7	14.4	13.8	13	11.6	11.1	10.4	9.3	9	8.5	8.2	7.7			USt
	8.9 → 89.3	161.9 - 165.9	27.6	27.6	27.6	24.7	20.7	19.4	17.7	15.4	14.6	13.8	12.5	11.9	11.2	10.2	9.8	9.3	8.9	8.5			USt P+
230	8.9 → 91.7	164.3 - 168.3	27.6	27.6	27.6	25.4	21.2	19.9	18.1	15.7	14.9	13.8	12.7	12.1	11.4	10.3	9.9	9.4					USt
	8.9 → 93.7	173.7 - 178.1	27.6	27.6	27.6	26.1	22	20.7	19	16.6	15.8	14.7	13.6	13	12.3	11.2	10.8	10.3					USt P+
213	8.9 → 89.5	164.7 - 168.8	27.6	27.6	27.6	24.8	20.9	19.6	17.9	15.7	14.9	13.8	12.8	12.2	11.5	10.5							USt
	8.9 → 94	174.3 - 177.9	27.6	27.6	27.6	26.2	22.1	20.7	19	16.7	15.9	14.8	13.6	13	12.3	11.2							USt P+
197	8.9 → 90.3	166.3 - 170.6	27.6	27.6	27.6	25.1	21.1	19.8	18.1	15.8	15.1	14	12.9	12.4	11.7								USt
	8.9 → 95.4	176.9 - 180.6	27.6	27.6	27.6	26.6	22.5	21.1	19.4	17	16.1	15	13.8	13.2	12.5								USt P+
180	8.9 → 89.9	165.5 - 169.7	27.6	27.6	27.6	24.9	21	19.7	18	15.7	15	13.9	12.8										USt
	8.9 → 93.5	173.3 - 177.2	27.6	27.6	27.6	26	22	20.7	18.9	16.6	15.8	14.7	13.5										USt P+
164	8.9 → 93.2		27.6	27.6	27.6	26	21.9	20.5	18.8	16.4	15.6	14.5											USt
	8.9 → 98		27.6	27.6	27.6	27.4	23.1	21.8	20	17.5	16.6	15.5											USt P+
148	8.9 → 92		27.6	27.6	27.6	25.6	21.5	20.2	18.5	16.2													USt
	8.9 → 95.4		27.6	27.6	27.6	26.6	22.5	21.1	19.4	17													USt P+
131	8.9 → 92		27.6	27.6	27.6	25.6	21.5	20.2	18.5														USt
	8.9 → 93.8		27.6	27.6	27.6	26.2	22.1	20.7	19														USt P+
115	8.9 → 92.7		27.6	27.6	27.6	25.8	21.7																USt
	8.9 → 94.6		27.6	27.6	27.6	26.4	22.3																USt P+

$W_{1.5} = W_{1.0} - 0.41 \text{ USt max.}$

Jib weight & counter-jib ballast

▼ (ft)	▼ (lb) (+/- 5%)		132 HPL™			180 HPL™ GH		
	▼ → 13.8 USt	▼ → 13.8 USt	13,228 lb	8,818 lb	▼ (lb)	13,228 lb	8,818 lb	▼ (lb)
262 ft	58,908	59,988	6	0	79,366	5	0	66,139
246 ft	56,593	57,673	6	0	79,366	5	0	66,139
230 ft	55,380	56,460	6	0	79,366	5	0	66,139
213 ft	52,900	53,980	4	2	70,548	3	2	57,320
197 ft	52,305	53,385	4	2	70,548	3	2	57,320
180 ft	49,824	50,905	4	1	61,729	3	1	48,502
164 ft	46,198	47,278	5	1	74,957	4	1	61,729
148 ft	43,718	44,798	3	3	66,139	2	3	52,911
131 ft	39,562	40,642	3	2	57,320	2	2	44,092
115 ft	37,082	38,162	2	3	52,911	1	3	39,683

CBC - 13,228 lb



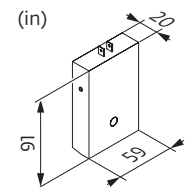
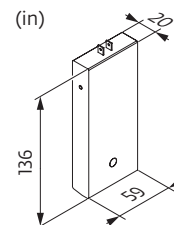





CBD - 8,818 lb

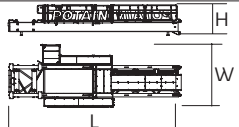
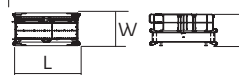

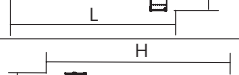
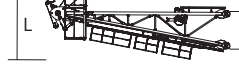

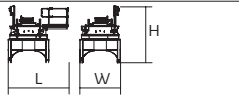
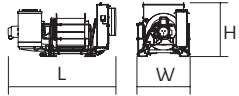
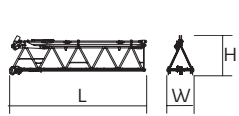
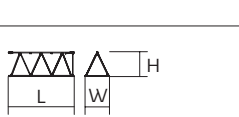
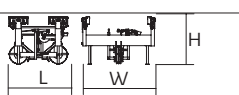

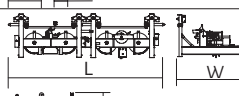
Dimensions and weight

Slewing crane part:  262 ft -  -  132 HPL™

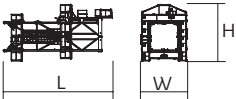

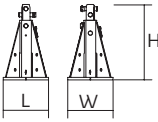
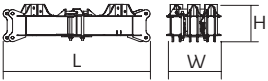
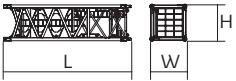
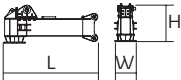
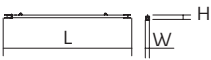
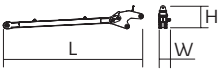
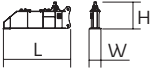
Slewing crane part		L (ft)	W (ft)	H (ft)	lb (+/- 5%)	
Counter-jib		38.4	13.5	6.4	14,308	
		13.8	6.6	6.4	4,365	
		36.2	11.7	6.8	10,858	
						
Cathead		11.6	6.5	32.3	18,221	
Cab		Ultra View 16.4	8.2	9.1	4,134	
Towerhead		18 ft	12.1	9.5	25,485	
Hoisting winch (+ rope)		132 HPL™	12.4	6.1	6.2	11,387
		180 HPL™ GH	15.8	6.3	6.5	19,279
Jib section		①	34	6.2	8.3	11,241
		② 10 DVF	33.9	6.2	7.7	10,944
		③	33.6	6.2	7.9	6,634
		④	33.6	6.2	7.6	6,105
		⑤	33.6	6.2	7.6	6,279
Jib section		⑥	33.5	6.2	6.6	3,075
		⑦	17.5	6.2	7.4	4,222
		⑧	17.2	6.2	6.7	2,476
		⑩	17	6.2	6.5	1,215
Trolley + Pulley block		 27.6 USt	5.9	7.4	4.7	1,676
			3.9	1.4	7.8	1,874
Trolley + Pulley block		 27.6 USt	13.5	7.2	3.8	2,635
			6	1.1	7.7	1,995

Crane Tower		L (ft)	W (ft)	H (ft)	lb (+/- 5%)	
Telescopic cage T 851		8 ft	36.7	15.9	19	34,723
K 85/K 85-2 Telescoping mast		8 ft	7.3	10.7	8.2	7,937
KM 850.10B KM 850.14B KMT 850.10A KMT 850.14A K 88/K 85A2 KM 880.10A KMT 850.10C		8 ft	33.9 33.9 17.5 17.5 17.5 17.8 12	8.3 8.3 8.3 8.3 8.2 8.3 8.3	8.2 8.2 8.2 8.2 8.2 8.3 8.2	22,201 24,670 12,015 13,206 18,281 18,453 9,326
Fixing angles		P 854A P 880A	3 3.3	3 3.3	4.9 6.2	2,072 3,536
Central cross (transport position)		JM 850	17.1	5.6	4.9	14,771
Basic mast unit		JM 850	28.7	8.2	8.2	32,187
Chassis girder		JM 850	17.1	3	5.1	7,055
Chassis ties		JM 850	23.6	0.8	1.1	551
Struts		JM 850	26.9	2.5	4.3	5,071
1/2 Cross girder		ZY 854	18.7	3.2	7.4	14,176
Cross girder		ZY 854	39	4.7	7.4	30,865

Mechanisms

480 V - 60 Hz													hp	kW	
	132 HPL™ 63	fpm	133	172	243	363	502	67	87	125	185	251	132	98	2,815 ft
		USt	13.8	10.4	6.9	3.4	1.1	27.6	20.7	13.8	6.9	2.9			
	180 HPL™ 63 GH	fpm	179	220	289	438	640	90	112	149	238	320	180	132	3,937 ft
		USt	13.8	10.4	6.9	3.4	0.9	27.6	20.7	13.8	6.9	3.3			
	10 DVF 10 Optima	fpm	0 → 217 (27.6 USt) 0 → 262 (22 USt) 0 → 328 (13.8 USt) 0 → 361 (6.9 USt)									10	7.4		
	RVF 173 Optima+	rpm	0 → 0.8									3 x 10	3 x 7.5		

IEC 60204-32	kVA	
480 V (+6% -10%) 60 Hz	132 HPL™: 142 → 90 kVA	
	180 HPL™ GH: 181 → 109 kVA	

These mast combinations meet the EN 14439 and ASME B30.3-2016 specifications for "out of service" wind conditions, provided the illustrated wind speed matches required design wind speed for the location of the tower crane. The "out of service" design wind speed was determined in accordance with ASCE 7-10, Figure 26.5-1A. The wind velocity, used for this configuration was 98 mph (158 kph), which represents a nominal design 3-second wind gust at 33 ft (10 m) above ground for Exposure B category. A factor of 0.85 was applied to the 700-year ultimate design wind speed of 115 mph (185 kph), per ASCE 37-02, with the assumption that this crane is considered a temporary structure used during a construction period of 2 years or less.

- Standard equipment
- Options
- Potain Plus function: Plus load curves
- Hook heights with Plus load curves
- Reactions in service
- Reactions out of service
- Total ballast weight
- Jib weight
- Lorry 44 ft
- Container High Cube 40 ft, and/or Flat Rack 20 ft
- Hoisting
- Trolleying
- Slewing
- Travelling
- Required power
- Power Control Function: winch speeds adapted to the available power
- Consult us

This commercial document is not legally binding. For any technical information, please refer to the corresponding instructions.

