

GROVE®

RT9130E

product guide

features

- 130 ton (120 mt) capacity
- 42-160 ft. (12.8-48.8 m) 5-section, full power boom
- 36-59 ft (11-18 m) offsettable bi-fold swingaway extension
- 26 ft. (8 m) extension inserts
- Grove MEGAFORM™ boom
- 300HP (224 kW) Tier III Cummins diesel engine
- Grove "E" series cab



contents

Features

2

Specifications

3

Dimensions & Weights

5

Working Range

6

Load Charts

7

Working Range w/Inserts

11

Load Chart w/Inserts

12

Load Chart on Rubber

13

Working Range Luffing

14

Luffing Extension Charts

16

Load Handling

23

Rough Terrain Hydraulic Crane

features and benefits

2



Removable front and rear outrigger boxes provide up to 19,374 lbs. (8 788 kg) of weight reduction for easier transport. Include the removable 40,000 lbs. (18 100 kg) of counterweight, auxiliary hoist and rope, and the RT9130E can easily self-remove close to 64,000 lbs. (29 000 kg).



The 160 ft. (48.8 m) 5 section Full Power boom incorporates the “U” shaped MEGAFORM™ design, which eliminates stiffeners, thus reducing weight and increasing capacity.



The “E” Series cab on the RT9130E tilts up to 20° providing the operator additional comfort when working at long boom and extension lengths.

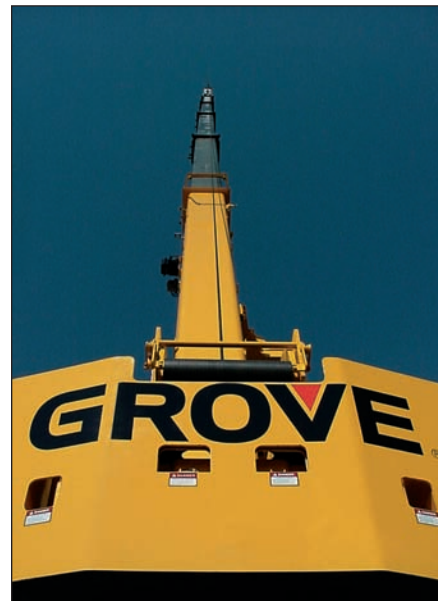

In addition to the 130 ton capacity, the RT9130E is different from any other rough terrain crane in the industry because of its enormous reach.

A 59 ft. (18 m) offsettable bi-fold lattice swingaway extension and two-26 ft. (8 m) inserts give the RT9130E a maximum tip height of 279 ft. (85 m). A hydraulically offsettable bi-fold lattice swingaway is also available, and conveniently offsets from 0' to 40' from the operator's cab.

Only on all-terrain cranes could this kind of main boom and extension height be achieved ... until now.

superstructure specifications

3

Superstructure

Boom

42 ft. - 160 ft. (12.8 m - 48.8 m) five-section, sequenced synchronized full power boom.
Maximum tip height: 169 ft. (51.5 m)

Lattice Extension

36 ft. - 59 ft. (11 m - 18 m) offsettable bifold lattice swingaway extension. Offsets 0°, 20° and 40°. Stows alongside base boom section.
Maximum tip height: 227 ft. (69.2 m)

*Optional Lattice Extension

36 ft. - 59 ft. (11 m - 18 m) hydraulically offsettable bifold lattice swingaway extension. Offsets from 0° to 40°. Stows alongside base boom section.
Maximum tip height: 227 ft. (69.2 m)

*Optional Lattice Extension Inserts

(2) x 26 ft (8 m) lattice extension inserts. Installs between the boom nose and bifold extension, nonstowable. Maximum tip height: 279 ft. (85 m)

Boom Nose

Seven nylontron sheaves mounted on heavy duty tapered roller bearings with removable pin-type rope guards. Quick reeving type boom nose. Removable auxiliary boom nose with removable pin type rope guard.

Boom Elevation

One double acting hydraulic cylinder with integral holding valve provides elevation from -3° to 78°.

Load Moment & Anti-Two Block System

Standard "Graphic Display" load moment and anti-two block system with audio-visual warning and control lever lockout. These systems provide electronic display of boom angle, length, radius, tip height, relative load moment, maximum permissible load, load indication and warning of impending two-block condition. The standard Work Area Definition System allows the operator to pre-select and define safe working areas. If the crane approaches the pre-set limits, audio-visual warnings aid the operator in avoiding job-site obstructions.

Cab

20° tilt, full-vision, all-steel fabricated with acoustical lining and tinted safety glass throughout. Deluxe seat incorporates armrest-mounted hydraulic single-axis controllers. Dash panel incorporates gauges for all engine functions. Other standard features include: hot water heater, cab circulating air fan, sliding side and rear windows, sliding skylight with electric wiper and sunscreen, electric windshield wash/wipe, fire extinguisher and seat belt.

Swing

Two speed, (2) planetary swing drives with foot applied multi-disc wet brakes. Spring applied, hydraulically released swing brakes. 360° positive swing lock and 2 position mechanical house lock, both operated from cab. Maximum speed: 2.5 RPM

Counterweight

40,000 lb. (18 144 kg) of total counterweight. Hydraulically installed and removed.

Hydraulic System

Six main pumps with a combined capacity of 205 GPM (776 LPM).

Maximum operating pressure: 4800 psi (331 bar).

Two individual post pressure compensated valve banks. Return line type filter with full flow by-pass protection and service indicator. Replaceable cartridge with micron filtration rating of 5/12/16.

325 gallons (1230 L) reservoir. Remote mounted oil cooler with thermostatically controlled hydraulic driven motor, fan/air to oil. System pressure test ports.

Hoist Specifications Main and Auxiliary Hoist

Planetary reduction with automatic spring applied multi-disc brake. Grooved drum electronic hoist drum rotation indicator, and hoist drum cable followers.

Maximum Single Line Pull:	1st layer - 19,267 lb. (8 740 kg)
	3rd layer - 16,384 lb. (7 432 kg)
	5th layer - 14,251 lb. (6 464 kg)

Maximum Permissible Line Pull:
16,800 lb. (7 620 kg) with 6x37 class rope
16,800 lb. (7,620 kg) with 35x7 class rope

Maximum Single Line Speed: 562 FPM (171 m/min)

Rope Class:
6x37 EIPS IWRC, Special Flexible
35x7 EIPS WSC, Rotation Resistant

Rope Diameter: 3/4" (19 mm)

Rope Length:
Main Hoist - 950 ft. (290 m)
Auxiliary Hoist - 700 ft. (213 m)

Maximum Rope Stowage: 1,206 ft. (368 m)

RT9130E

carrier specifications

4

Carrier



Chassis

Box section frame fabricated from high-strength, low alloy steel. Removable outrigger housings, front/rear towing and tie down lugs.



Outrigger System

Four hydraulic telescoping single-stage double box beam outriggers with inverted jacks and integral holding valves. Three position settings, 0%, 50% and fully extended. Outrigger boxes removable for ease of transportation. All steel fabricated, quick release type outrigger floats, 30.5" (775 mm) diameter. Maximum outrigger pad load - 166,000 lb. (75 298 kg)



Outrigger Controls

Controls and crane level indicator located in cab.



Engine (Tier III)

Cummins QSC8.3L diesel, six cylinders, 300 bhp (224 kW) (Gross) @ 2,200 RPM
Maximum torque: 1000 ft. lb. (1356 Nm) @ 1,600 RPM



Fuel Tank Capacity

100 gallons (379 L)



Transmission

Full powershift with 6 forward and 3 reverse speeds. Front axle disconnect for 4 x 2 travel.



Electrical System

Two 12 V - maintenance free batteries.
12 V starting and lighting, circuit breakers.



Drive

4 x 4



Steering

Fully independent power steering:
Front: Full hydraulic steering wheel controlled.
Rear: Full hydraulic switch controlled.
Provides infinite variations of 4 main steering modes: front only, rear only, crab and coordinated.
Rear steer centered indicator light.



Axles

Front: Drive/steer with differential and planetary reduction hubs rigid mounted to frame.
Rear: Drive/steer with differential and planetary reduction hubs pivot mounted to frame.



Oscillation Lockouts

Automatic full hydraulic lockouts on rear axle permits 10 in. (254 mm) oscillation with boom centered over the front.



Brakes

Full hydraulic split circuit, dry disc service brakes operating on all wheels. Spring-applied, hydraulically released parking brake mounted on front axle.



Tires

Std. 33.25 x 29 - 38 bias ply, General SL-100



Lights

Full lighting including turn indicators, head, tail, brake and hazard warning lights.



Maximum Speed

15 MPH (24 km/h)



Gradeability (Theoretical)

73% (Based on 180,000 lb. [81 647 kg] GVW) 33.25 x 29 tires, pumps engaged, 160 ft. (48.8 m) boom, plus 59 ft. (18 m) swingaway, 40,000 lb. (18 144 kg) counterweight, hookblock and headache ball.

Miscellaneous Standard Equipment

Full width aluminum fenders, full length aluminum decking, dual rear view mirrors, hook-block tie down, electronic back-up alarm, light package, front stowage well, tachometer/hourmeter, immersion type block heater, rear wheel position indicator, 36,000 BTU hot water cab heater, hoist mirrors, engine distress A/V warning system, front/rear tie down and tow lugs, coolant sight level indicator, hydraulic pump disconnect, LMI light bar. Hydraulically activated boom removal pins, lift cylinder travel support, 80T hookblock, 10T top swivel ball.

*Optional Equipment

- *AUXILIARY LIGHTING PACKAGE (includes cab mounted amber flashing light, 360° rotation spotlight and dual base boom mounted floodlights)
- *Air conditioning
- *130 ton hookblock
- *Rear pintle hook
- *Cab controlled cross axle differential locks, (front and rear)
- *PAT datalogger down load kit
- *Rubber mat for stowage trough
- *Tire removal tool

*Denotes optional equipment

RT9130E

dimensions

5

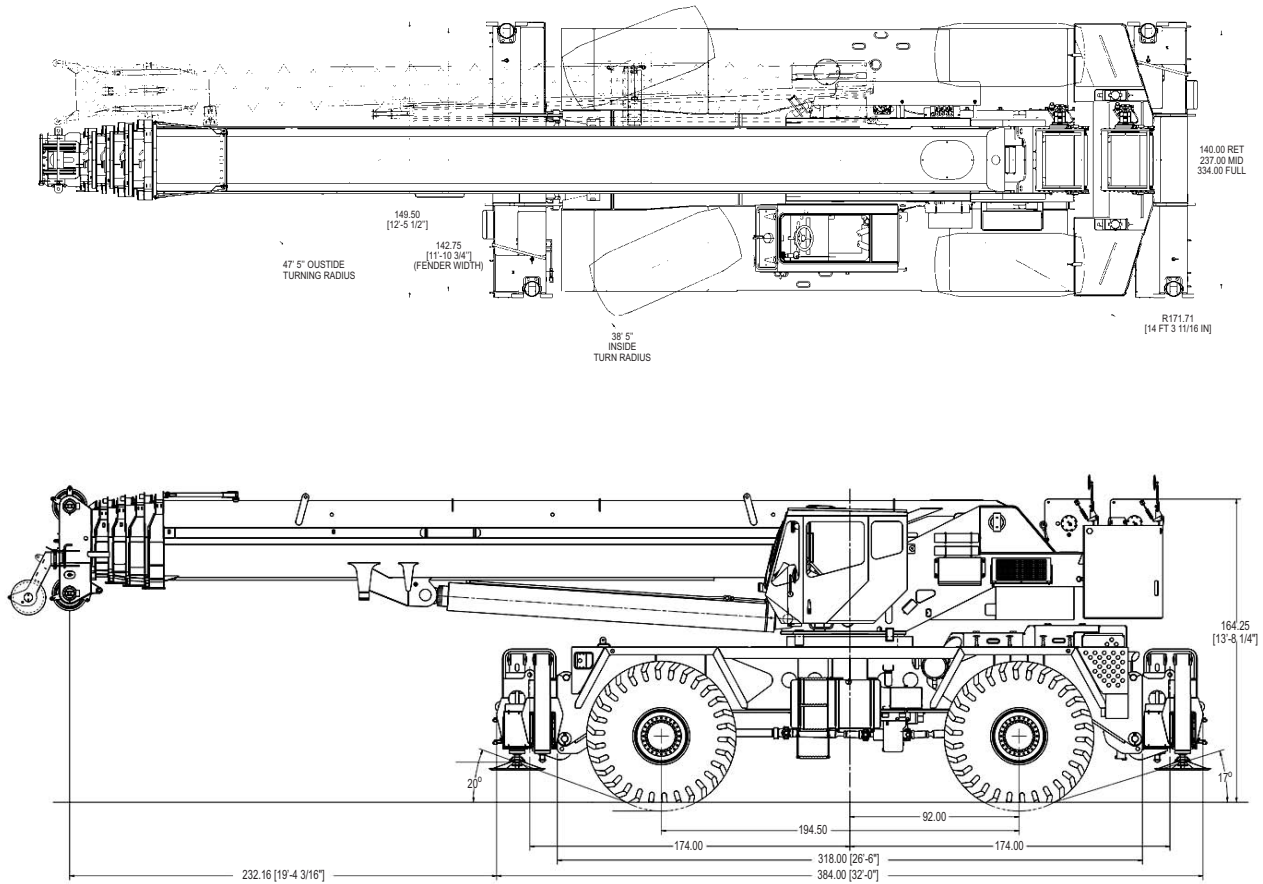

Weight Configurations

RT9130E Basic Machine

Configuration	RT9130E Largest (lbs.)	Items Removed (lbs.)						Weight of Items Removed (lbs.)
		Boxes	STD Cwt	Aux Hoist	Boom	Bifold	Block &/or Ball	
Complete Machine: 2 Hoists w/Rope, MAFX Counterweight, Bifold Extension, Block, Ball, 33.25 x 25 Tires	174,034							
Remove 40K Cwt, Aux Hoist w/Mt & Rope	129,075		40,000	4,084				44,084
Remove 40K Cwt, Aux Hoist w/Mt & Rope, Tires	119,555		40,000	4,084			9,520	53,604
Remove 40K Cwt, Aux Hoist w/Mt & Rope, Bifold, Tires	116,445		40,000	4,084		3,100	9,520	56,714
Remove 40K Cwt, Aux Hoist w/Mt & Rope, O/R Boxes	111,103	18,842	40,000	4,084				62,926
Remove 40K Cwt, Aux Hoist w/Mt & Rope, Bifold, Block, O/R Boxes	106,398	18,842	40,000	4,084		3,100	1,600	67,636
Remove Boom, Bifold, Block, Ball, 40K Cwt, Aux Hoist w/Mt & Rope	91,060		40,000	4,084	33,500	3,100	2,280	82,974
Remove Boom, Bifold, Block, Ball, 40K Cwt, Aux Hoist w/Mt & Rope, Tires	81,540		40,000	4,084	33,500	3,100	2,280	92,494
Remove Boom, Bifold, Block, Ball, 40K Cwt, Aux Hoist w/Mt & Rope, O/R Boxes	72,218	18,842	40,000	4,084	33,500	3,100	2,280	101,816

RT9130E

working range

Working range – 160 ft. Main Boom + 36-59 ft. Fixed Offset Extension

6

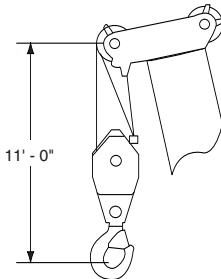
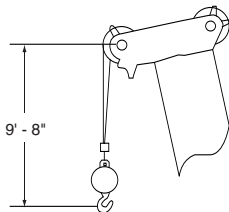
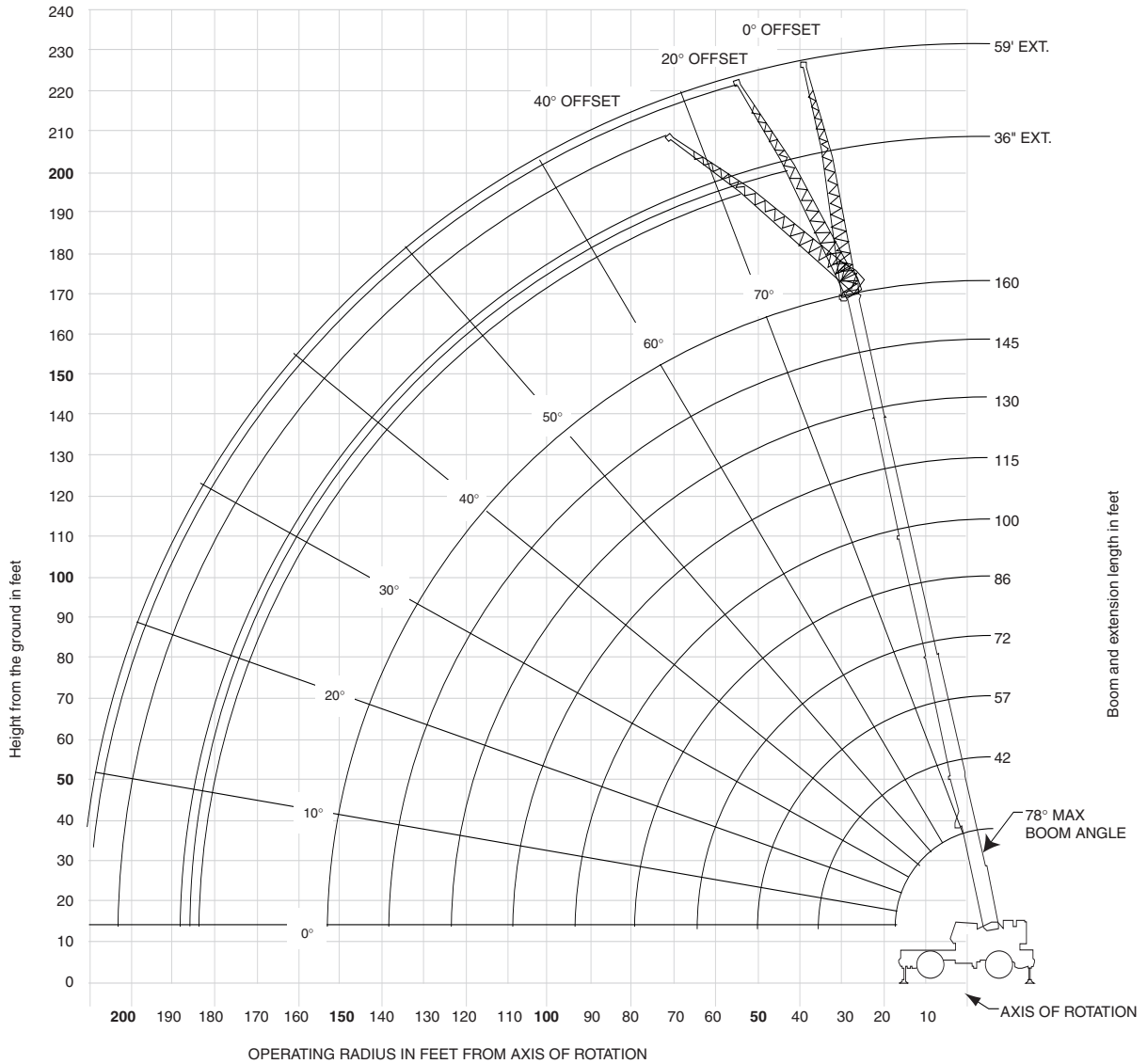

Dimensions are for Largest Grove furnished Hook Block and Headache Ball, with Anti-Two Block Activated.

THIS CHART IS ONLY A GUIDE AND SHOULD NOT BE USED TO OPERATE THE CRANE. The individual crane's load chart, operating instructions and other instructional plates must be read and understood prior to operating the crane.

RT9130E

GROVE

RT9130E load chart



Feet	Pounds								
	#0001								
	Main Boom Length in Feet								
	42	57	72	86	100	115	130	145	160
10	+260,000 (71.5)	147,000 (76.5)							
12	224,000 (68.5)	147,000 (74.5)	* 127,000 (78)						
15	176,000 (63.5)	147,000 (71.5)	127,000 (76)	*92,600 (78)					
20	127,500 (55.5)	125,500 (65.5)	115,500 (71.5)	86,550 (75.5)	*65,000 (78)				
25	97,300 (46)	95,550 (60)	95,300 (67)	78,900 (72)	62,650 (75)	44,600 (78)			
30	76,900 (34)	75,250 (53.5)	75,050 (62.5)	68,500 (68.5)	56,800 (72)	44,600 (75.5)	43,150 (78)		
35		60,950 (46.5)	60,750 (58)	60,100 (64.5)	50,050 (69)	44,600 (73)	42,200 (76)	32,550 (78)	
40		50,300 (38.5)	50,150 (52.5)	50,550 (60.5)	44,050 (66)	41,400 (70)	38,000 (73.5)	32,550 (76)	25,100 (78)
45		42,050 (28)	41,950 (47)	42,350 (56.5)	38,950 (62.5)	37,450 (67.5)	34,150 (71)	32,550 (74)	24,800 (76.5)
50			35,400 (41)	35,850 (52.5)	34,650 (59)	33,450 (64.5)	31,350 (68.5)	29,550 (71.5)	24,500 (74.5)
55			30,050 (34)	30,550 (47.5)	30,050 (55.5)	30,000 (61.5)	29,200 (66)	26,850 (69.5)	24,000 (72.5)
60			25,600 (24.5)	26,100 (42.5)	25,850 (52)	26,950 (58.5)	26,350 (63.5)	24,700 (67.5)	23,200 (70.5)
65				22,400 (37)	22,150 (48)	23,800 (55.5)	23,850 (61)	22,950 (65)	21,100 (68.5)
70				19,200 (30.5)	18,950 (44)	20,800 (52.5)	21,600 (58.5)	20,850 (62.5)	19,200 (66.5)
75				16,400 (22)	16,200 (39)	18,100 (49)	19,250 (55.5)	19,000 (60.5)	17,500 (64.5)
80					13,800 (34)	15,700 (45.5)	16,900 (52.5)	17,100 (58)	15,750 (62.5)
85					11,650 (28)	13,550 (41.5)	15,000 (49.5)	15,500 (55.5)	14,300 (60)
90					9,770 (19.5)	11,700 (37)	13,100 (46.5)	13,900 (53)	13,100 (58)
95						10,000 (32)	11,450 (43)	12,250 (50)	12,150 (55.5)
100						8,490 (26.5)	9,940 (39.5)	11,000 (47)	11,400 (53)
105						5,690 (18.5)	8,630 (35.5)	9,730 (44)	10,200 (60.5)
110							7,320 (30.5)	8,460 (41)	9,020 (48)
115							6,220 (25)	7,370 (37.5)	8,100 (45.5)
120							5,120 (17.5)	6,280 (33.5)	7,190 (42.5)
125								5,350 (29.5)	6,270 (39.5)
130								4,430 (24)	5,350 (36)
135								2,560 (16.5)	4,560 (32.5)
140									3,770 (28)
									23
									145

#LMI operating code. Refer to LMI manual for instructions.
 *This capacity is based upon maximum obtainable boom angle.
 +16 parts line required to lift this capacity (using aux. boom nose). Refer to Operator's and Safety Handbook for reeving diagram.
 Note: () Boom angles are in degrees.

Lifting Capacities at Zero Degree Boom Angle									
Boom Angle	Main Boom Length in Feet								
	42	57	72	86	100	115	130	145	160
0°	41,400 (35.3)	24,650 (50)	15,350 (64.6)	9,700 (79.3)	5,250 (94)	3,650 (108.6)	2,450 (123.3)	1,450 (138)	

Note: () Reference radii in feet

A6-829-103576

7

RT9130E

THIS CHART IS ONLY A GUIDE AND SHOULD NOT BE USED TO OPERATE THE CRANE. The individual crane's load chart, operating instructions and other instructional plates must be read and understood prior to operating the crane.

RT9130E load chart



100 ft. 36 - 59 ft. 40,000 lbs 100% 27' 10" spread 360°

8

Pounds						
Feet	36 ft. LENGTH			59 ft. LENGTH		
	0° OFFSET #0021	20° OFFSET #0022	40° OFFSET #0023	0° OFFSET #0041	20° OFFSET #0042	40° OFFSET #0043
25	*33,600 (78)					
30	33,600 (76.5)			*14,950 (78)		
35	32,950 (74.5)	*23,150 (78)		14,950 (77.5)		
40	31,050 (72)	22,150 (76.5)		14,950 (76)		
45	29,250 (70)	21,250 (74)	17,250 (78)	14,950 (74)		
50	27,600 (67.5)	20,450 (72)	16,850 (75.5)	14,950 (72)	12,350 (78)	
55	26,150 (65)	19,700 (69.5)	16,500 (73)	14,950 (70)	11,900 (77)	
60	24,750 (63)	19,050 (67)	16,150 (70.5)	14,800 (68)	11,500 (75)	
65	23,550 (60.5)	18,450 (65)	15,900 (68)	14,300 (66)	11,100 (73)	9,210 (78)
70	22,050 (58)	17,850 (62)	15,650 (65.5)	13,650 (64)	10,700 (71)	9,000 (76)
75	20,100 (55.5)	17,350 (59.5)	15,450 (63)	13,100 (62)	10,400 (69)	8,820 (73.5)
80	18,100 (52.5)	16,900 (57)	15,250 (60)	12,550 (60)	10,050 (66.5)	8,650 (71.5)
85	16,000 (50)	16,500 (54)	15,150 (57)	12,000 (58)	9,780 (64.5)	8,490 (69)
90	14,150 (47)	15,500 (51.5)	15,050 (54)	11,550 (55.5)	9,510 (62.5)	8,360 (66.5)
95	12,500 (44)	13,700 (48)	14,000 (50.5)	11,100 (53)	9,260 (60)	8,240 (64)
100	11,050 (40.5)	12,100 (45)	12,750 (47)	10,650 (51)	9,030 (57.5)	8,130 (61.5)
105	9,770 (37)	10,650 (41.5)		10,250 (48.5)	8,820 (55)	8,050 (59)
110	8,490 (33.5)	9,270 (37.5)		9,930 (46)	8,620 (52.5)	7,980 (56)
115	7,430 (29)	8,060 (33)		9,040 (43)	8,450 (49.5)	7,950 (53)
120	6,370 (24)	6,850 (28)		8,150 (40.5)	8,280 (47)	7,920 (50)
125				7,240 (37)	7,830 (43.5)	7,900 (46.5)
130				6,340 (34)	7,380 (40.5)	7,890 (42.5)
135				5,570 (30.5)	6,440 (36.5)	
140				4,800 (26)	5,510 (32)	
145				4,140 (21)		
150				3,480 (14)		
Min. boom angle for indicated length (no load)	0°	20°	40°	0°	20°	40°

Max. boom length at 0° boom angle (no load)

100 ft.

100 ft.

NOTE: () Boom angles are in degrees.
#LMI operating code. Refer to LMI manual for operating instructions.

A6-829-102109

*This capacity is based on maximum obtainable boom angle.

NOTES:

- All capacities above the bold line are based on structural strength of boom extension and do not exceed 85% of tipping loads, in accordance with SAE J-765.
- 36 ft. boom extension may be used for single or double line lifting service. 59 ft. boom extension may be used for single line lifting service only.
WARNING: Lifting with the 36 ft. extension base, with the 23 ft. extension fly either erected or folded along side of extension base, is strictly prohibited.
- Radii listed are for a fully extended boom with the boom extension erected. For main boom lengths less than fully extended, the rated loads are determined by boom angle. Use only the column which corresponds to the boom extension length and offset for which the machine is configured. For boom angles not shown, use the rating of the next lower boom angle.
WARNING: Operation of this machine with heavier loads than the capacities listed is strictly prohibited. Machine tipping with boom extension occurs rapidly and without advance warning.
- Boom angle is the angle above or below horizontal of the longitudinal axis of the boom base section after lifting rated load.
- Capacities listed are with outriggers properly extended and vertical jacks set only.

RT9130E

RT9130E load chart



Pounds						
Feet	36 ft. LENGTH			59 ft. LENGTH		
	0° OFFSET #0021	20° OFFSET #0022	40° OFFSET #0023	0° OFFSET #0041	20° OFFSET #0042	40° OFFSET #0043
35	23,350 (78)					
40	23,350 (77)			12,300 (78)		
45	23,350 (75)	*21,300 (78)		12,300 (77.5)		
50	23,350 (73.5)	20,700 (76.5)		12,300 (76)		
55	23,350 (71.5)	20,100 (75)	16,600 (78)	12,300 (74.5)		
60	23,350 (69.5)	19,500 (73)	16,350 (76)	12,300 (73)	11,600 (78)	
65	22,300 (67.5)	19,000 (71)	16,100 (74)	12,300 (71.5)	11,300 (77)	
70	20,350 (66)	18,500 (69)	15,850 (72)	12,300 (69.5)	10,950 (75)	
75	18,350 (64)	18,050 (67)	15,650 (70)	12,300 (68)	10,700 (73.5)	8,940 (78)
80	16,600 (62)	17,100 (65)	15,500 (68)	12,300 (66.5)	10,400 (72)	8,790 (76)
85	15,050 (60)	15,550 (63)	15,300 (66)	12,300 (64.5)	10,150 (70)	8,650 (74.5)
90	13,700 (57.5)	14,150 (61)	14,500 (63.5)	12,300 (63)	9,910 (68.5)	8,520 (72.5)
95	12,450 (55.5)	12,900 (58.5)	13,250 (61.5)	11,900 (61)	9,680 (66.5)	8,410 (70.5)
100	11,300 (53.5)	11,750 (56.5)	12,100 (59)	11,450 (59)	9,460 (64.5)	8,300 (68.5)
105	10,300 (51)	10,750 (54)	11,050 (56.5)	10,500 (57.5)	9,260 (63)	8,210 (66.5)
110	9,390 (48.5)	9,810 (52)	10,050 (54)	9,580 (55.5)	9,060 (61)	8,120 (64.5)
115	8,570 (46)	8,970 (49.5)	9,200 (51.5)	8,790 (53.5)	8,860 (59)	8,050 (62.5)
120	7,750 (43.5)	8,140 (46.5)	8,350 (48.5)	8,010 (51.5)	8,660 (57)	7,990 (60.5)
125	6,840 (41)	7,360 (44)	7,600 (45.5)	7,340 (49.5)	7,960 (54.5)	7,820 (58)
130	5,940 (38)	6,590 (41)	6,850 (42.5)	6,680 (47.5)	7,270 (52.5)	7,660 (55.5)
135	5,170 (34.5)	5,730 (37.5)		6,100 (45)	6,660 (50.5)	7,010 (53.5)
140	4,400 (31)	4,880 (34)		5,530 (42.5)	6,050 (48)	6,360 (50.5)
145	3,730 (27.5)	4,120 (30)		4,890 (40)	5,510 (45.5)	5,770 (48)
150	3,070 (22.5)	3,360 (25.5)		4,260 (37.5)	4,970 (42.5)	5,190 (45)
155				3,670 (35)	4,360 (40)	
160				3,090 (31.5)	3,750 (36.5)	
165				2,570 (28.5)	3,120 (33)	
170				2,060 (24.5)	2,490 (29)	
Min. boom angle for indicated length (no load)	20°	20°	40°	20°	20°	40°
Max. boom length at 0° boom angle (no load)	100 ft.			100 ft.		

NOTE: () Boom angles are in degrees.
 #LMI operating code. Refer to LMI manual for operating instructions
 *This capacity is based on maximum obtainable boom angle.

A6-829-102127

NOTES:

- All capacities above the bold line are based on structural strength of boom extension and do not exceed 85% of tipping loads, in accordance with SAE J-765.
- 36 ft. boom extension may be used for single or double line lifting service. 59 ft. boom extension may be used for single line lifting service only.
WARNING: Lifting with the 36 ft. extension base, with the 23 ft. extension fly either erected or folded along side of extension base, is strictly prohibited.
- Radii listed are for a fully extended boom with the boom extension erected. For main boom lengths less than fully extended, the rated loads are determined by boom angle. Use only the column which corresponds to the boom extension length and offset for which the machine is configured. For boom angles not shown, use the rating of the next lower boom angle.
WARNING: Operation of this machine with heavier loads than the capacities listed is strictly prohibited. Machine tipping with boom extension occurs rapidly and without advance warning.
- Boom angle is the angle above or below horizontal of the longitudinal axis of the boom base section after lifting rated load.
- Capacities listed are with outriggers properly extended and vertical jacks set only.

RT9130E load chart



10

		Pounds					
		36ft. LENGTH			59ft. LENGTH		
Feet	0° OFFSET #0021	20° OFFSET #0022	40° OFFSET #0023	0° OFFSET #0041	20° OFFSET #0042	40° OFFSET #0043	
							45
50	16,000 (77.5)						
55	15,900 (76)			10,100 (78)			
60	15,850 (74)	15,700 (77.5)		10,100 (77)			
65	15,800 (72.5)	15,700 (76)	*15,200 (78)	10,100 (75.5)			
70	15,750 (71)	15,000 (74.5)	14,750 (77)	10,100 (74)	10,050 (78)		
75	14,950 (69.5)	14,300 (73)	14,100 (75.5)	10,100 (73)	10,050 (77.5)		
80	14,200 (68)	13,600 (71)	13,450 (74)	10,100 (71.5)	10,050 (76)		
85	13,450 (66)	12,950 (69.5)	12,850 (72)	10,100 (70)	10,050 (74.5)	8,600 (78)	
90	12,800 (64.5)	12,350 (68)	12,250 (70.5)	10,100 (68.5)	9,870 (73)	8,500 (77.5)	
95	11,700 (63)	11,750 (66)	11,700 (68.5)	10,100 (67)	9,680 (72)	8,400 (75.5)	
100	10,650 (61)	11,200 (64.5)	11,200 (67)	9,710 (65.5)	9,450 (70)	8,310 (74)	
105	9,710 (59.5)	10,250 (62.5)	10,400 (65)	9,280 (64)	9,050 (68.5)	8,220 (72.5)	
110	8,780 (57.5)	9,310 (61)	9,680 (63)	8,850 (62.5)	8,650 (67)	8,140 (71)	
115	7,990 (55.5)	8,500 (59)	8,840 (61)	8,110 (61)	8,280 (65.5)	7,920 (69.5)	
120	7,210 (53.5)	7,690 (57)	8,010 (59)	7,370 (59.5)	7,920 (64)	7,700 (67.5)	
125	6,540 (52)	7,000 (55)	7,290 (57)	6,720 (57.5)	7,360 (62.5)	7,440 (66)	
130	5,880 (49.5)	6,310 (53)	6,580 (55)	6,070 (56)	6,810 (60.5)	7,190 (64)	
135	5,300 (47.5)	5,710 (51)	5,950 (53)	5,510 (54.5)	6,210 (59)	6,630 (62.5)	
140	4,730 (45.5)	5,110 (49)	5,330 (50.5)	4,950 (52.5)	5,620 (57)	6,080 (60.5)	
145	4,190 (43)	4,580 (46.5)	4,770 (48)	4,460 (50.5)	5,100 (55.5)	5,520 (58.5)	
150	3,650 (41)	4,060 (44)	4,220 (45.5)	3,980 (49)	4,580 (53.5)	4,970 (56.5)	
155	3,070 (38.5)	3,500 (41.5)	3,660 (43)	3,550 (47)	4,120 (51.5)	4,470 (54.5)	
160	2,490 (35.5)	2,940 (38.5)		3,130 (45)	3,660 (49.5)	3,970 (52)	
165	1,970 (32.5)	2,370 (36)		2,710 (43)	3,240 (47.5)	3,510 (50)	
170	1,460 (29.5)	1,800 (32.5)		2,300 (40.5)	2,830 (45)	3,060 (47.5)	
175				1,840 (38.5)	2,420 (43)	2,640 (45)	
180				1,390 (36)	2,010 (40)	2,220 (42)	
185					1,530 (37.5)		

NOTE: () Boom angles are in degrees. #LMI operating code. Refer to LMI manual for operating instructions. *This capacity is based on maximum obtainable boom angle.

- NOTES:**
- All capacities above the bold line are based on structural strength of boom extension and do not exceed 85% of tipping loads, in accordance with SAE J-765.
 - 36 ft. boom extension may be used for single or double line lifting service. 59 ft. boom extension may be used for single line lifting service only. **WARNING:** Lifting with the 36 ft. extension base, with the 23 ft. extension fly either erected or folded along side of extension base, is strictly prohibited.
 - Radii listed are for a fully extended boom with the boom extension erected. For main boom lengths less than fully extended, the rated loads are determined by boom angle. Use only the column which corresponds to the boom extension length and offset for which the machine is configured. For boom angles not shown, use the rating of the next lower boom angle. **WARNING:** Operation of this machine with heavier loads than the capacities listed is strictly prohibited. Machine tipping with boom extension occurs rapidly and without advance warning.
 - Boom angle is the angle above or below horizontal of the longitudinal axis of the boom base section after lifting rated load.
 - Capacities listed are with outriggers properly extended and vertical jacks set only.

RT9130E

THIS CHART IS ONLY A GUIDE AND SHOULD NOT BE USED TO OPERATE THE CRANE. The individual crane's load chart, operating instructions and other instructional plates must be read and understood prior to operating the crane.

working range

Working range – 160 ft. Main Boom + (2) Inserts + 36-59 ft. Fixed Offset Extension

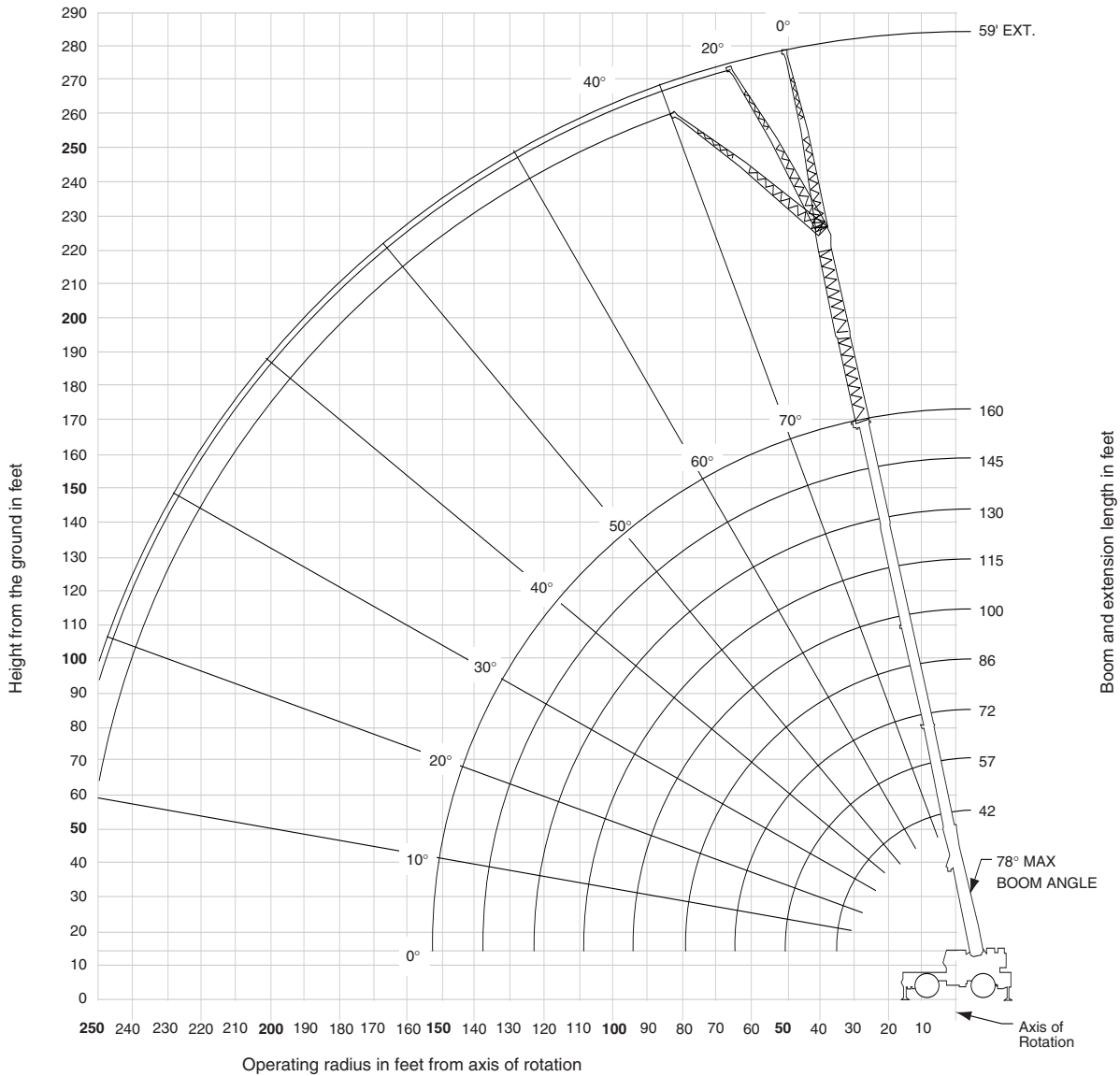

11

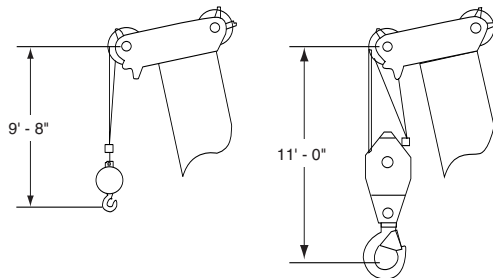

Dimensions are for largest Grove furnished Hook Block and Headache Ball, with Anti-Two Block Activated.

THIS CHART IS ONLY A GUIDE AND SHOULD NOT BE USED TO OPERATE THE CRANE. The individual crane's load chart, operating instructions and other instructional plates must be read and understood prior to operating the crane.

RT9130E

RT9130E load chart

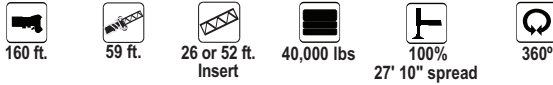

12

Pounds						
Feet	59 ft. LENGTH WITH 26 ft. INSERT			59 ft. LENGTH WITH 52 ft. INSERT		
	0° OFFSET #0084	20° OFFSET #0085	40° OFFSET #0086	0° OFFSET #0084	20° OFFSET #0085	40° OFFSET #0086
60	7,070 (78)					
65	7,070 (77.5)					
70	7,070 (76.5)			4,400 (78)		
75	7,070 (75)			4,400 (77.5)		
80	7,070 (74)	6,610 (78)		4,400 (76.5)		
85	7,070 (72.5)	6,610 (77.5)		4,400 (75.5)		
90	7,070 (71.5)	6,610 (76)		4,400 (74.5)	4,230 (78)	
95	7,070 (70)	6,610 (75)	6,400 (78)	4,400 (73)	4,230 (77.5)	
100	7,070 (69)	6,610 (73.5)	6,400 (77)	4,400 (72)	4,230 (76.5)	
105	7,070 (67.5)	6,610 (72.5)	6,400 (76)	4,400 (71)	4,230 (75.5)	4,000 (78)
110	7,070 (66)	6,610 (71)	6,400 (74.5)	4,400 (69.5)	4,230 (74)	4,000 (77)
115	6,735 (65)	6,545 (69.5)	6,315 (73)	4,400 (68.5)	4,230 (73)	4,000 (75.5)
120	6,400 (63.5)	6,480 (68)	6,230 (71.5)	4,400 (67.5)	4,230 (72)	4,000 (74.5)
125	5,940 (62)	6,170 (67)	5,955 (70)	4,400 (66)	4,230 (70.5)	4,000 (73)
130	5,480 (60.5)	5,860 (65.5)	5,680 (68.5)	4,400 (65)	4,230 (69.5)	4,000 (72)
135	4,930 (59.5)	5,510 (64)	5,440 (67)	4,110 (63.5)	4,195 (68)	4,000 (70.5)
140	4,380 (58)	5,160 (62.5)	5,200 (65.5)	3,820 (62.5)	4,160 (67)	4,000 (69)
145	3,900 (56.5)	4,645 (61)	4,910 (64)	3,350 (61)	3,885 (65.5)	3,785 (68)
150	3,420 (55)	4,130 (59.5)	4,620 (62.5)	2,880 (60)	3,610 (64)	3,570 (66.5)
155	3,000 (53.5)	3,680 (58)	4,140 (60.5)	2,470 (58.5)	3,205 (63)	3,365 (65)
160	2,580 (51.5)	3,230 (56.5)	3,660 (59)	2,060 (57)	2,800 (61.5)	3,160 (63.5)
165	2,210 (50)	2,825 (54.5)	3,220 (57.5)	1,690 (56)	2,405 (60)	2,810 (62.5)
170	1,840 (48.5)	2,420 (53)	2,780 (55.5)		2,010 (59)	2,460 (61)
175	1,515 (46.5)	2,060 (51)	2,385 (53.5)		1,655 (57.5)	2,075 (59.5)
180		1,700 (49.5)	1,990 (51.5)			1,690 (58)
185		1,370 (47.5)	1,625 (49.5)			
Min. boom angle (°) for indicated length (no load)	45	46	48	54	56	56
Max. boom length (ft.) at 0° boom angle (no load)		57		57		

NOTE: () Boom angles are in degrees.
#LMI operating code. Refer to LMI manual for operating instructions.

A6-829-101983A

NOTES:

- All capacities above the bold line are based on structural strength of boom extension and do not exceed 85% of tipping loads, in accordance with SAE J-765.
- 59 ft. folding boom extension length may be used for single line lifting service only.
NOTE: Lifting with the 36 ft. extension base with either one or two 26 ft. insert sections installed is not permitted.
- For main boom lengths less than 160 ft. with the boom extension erected, the rated loads are determined by boom angle. Use only the column which corresponds to the boom extension length and offset for which the machine is set up. For boom angles not shown, use the rating of the next lower boom angle.
- WARNING:** Operation of this machine with heavier loads than the capacities listed is strictly prohibited. Machine tipping with boom extension occurs rapidly and without advance warning.
- Boom angle is the angle above or below horizontal of the longitudinal axis of the boom base section after lifting rated load.
- Capacities listed are with outriggers properly extended and vertical jacks set only.

RT9130E

THIS CHART IS ONLY A GUIDE AND SHOULD NOT BE USED TO OPERATE THE CRANE. The individual crane's load chart, operating instructions and other instructional plates must be read and understood prior to operating the crane.

RT9130E load chart

13

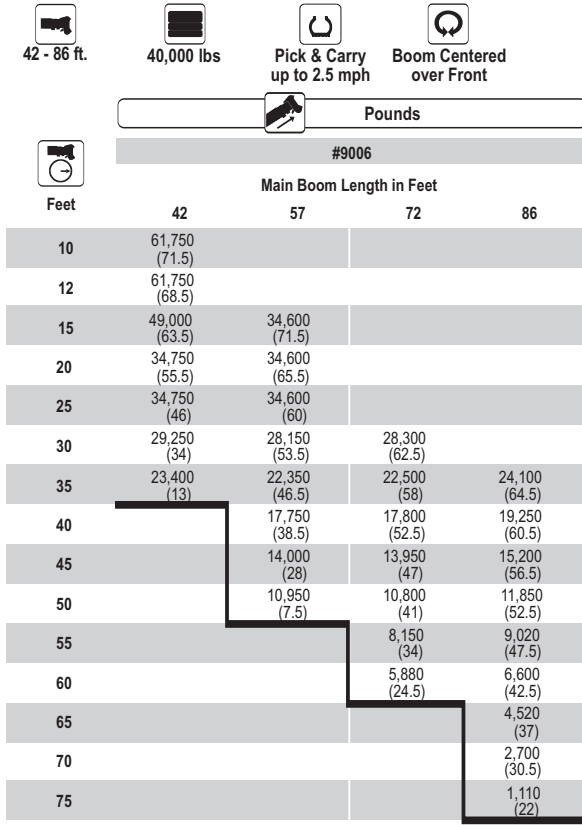

Min. boom angle (°) for indicated length (no load) 0 20

Max. boom length (ft.) at 0° boom angle (no load) 72

#LMI operating code. Refer to LMI manual for operating instructions.
NOTE: () Boom angles are in degrees.

Lifting Capacities at Zero Degree Boom Angle

Boom Angle	42	57
0°	23,000 (35.3)	10,900 (50)

A6-829-102108A

- NOTES:**
1. Capacities are in pounds and do not exceed 75% of tipping loads as determined by test in accordance with SAE J-765.
 2. Capacities are applicable to machines equipped with 33.25x29 (38 ply) bias ply tires, at 85 psi cold inflation pressure.
 3. Capacities appearing above the bold line are based on structural strength and tipping should not be relied upon as a capacity limitation.
 4. Capacities are applicable only with machine on firm level surface.
 5. On rubber lifting with boom extension not permitted.
 6. Axle lockouts must be functioning when lifting on rubber.
 7. For pick and carry operation, boom must be centered over front of machine, mechanical swing lock engaged and load restrained from swinging. When handling loads in the structural range with capacities close to maximum ratings, travel should be reduced to creep speeds.
 8. All lifting depends on proper tire inflation, capacity and condition. Capacities must be reduced for lower tire inflation pressures. See lifting capacity chart for tire used. Damaged tires are hazardous to safe operation of crane.
 9. Creep - not over 200 ft. of movement in any 30 minute period and not exceeding 1 mph.

THIS CHART IS ONLY A GUIDE AND SHOULD NOT BE USED TO OPERATE THE CRANE. The individual crane's load chart, operating instructions and other instructional plates must be read and understood prior to operating the crane.

working range

Working range – 160 ft. Main Boom + 36-59 ft. Luffing Extension

14

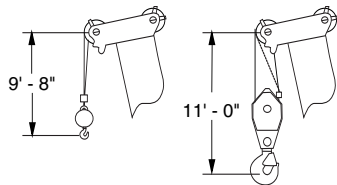
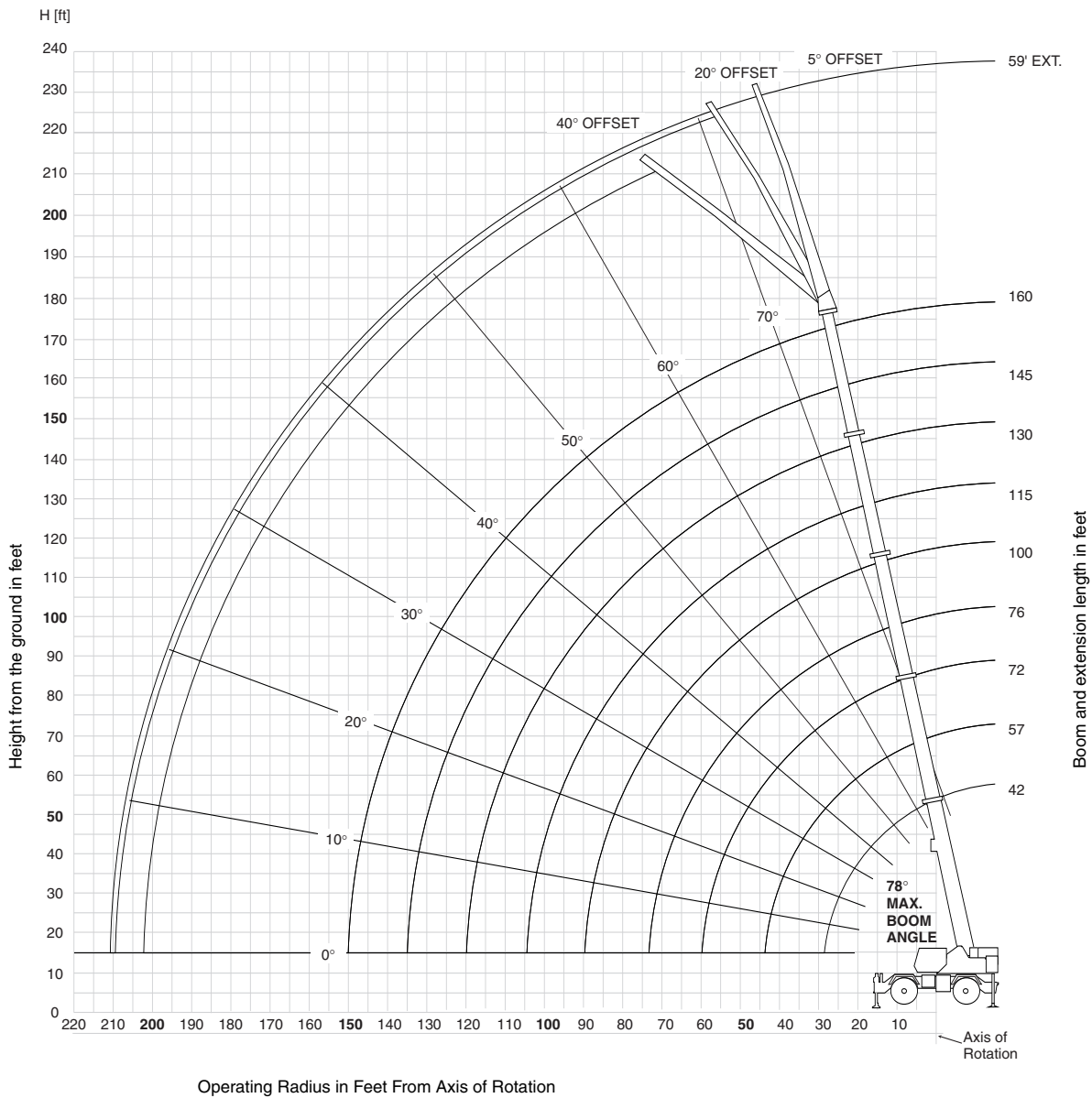

Dimensions are for Largest Grove furnished Hook Block and Headache Ball, with Anti-Two Block Activated.

THIS CHART IS ONLY A GUIDE AND SHOULD NOT BE USED TO OPERATE THE CRANE. The individual crane's load chart, operating instructions and other instructional plates must be read and understood prior to operating the crane.

RT9130E

working range

Working range – 160 ft. Main Boom + (2) Inserts + 36-59 ft. Luffing Extension

15

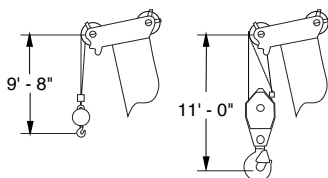
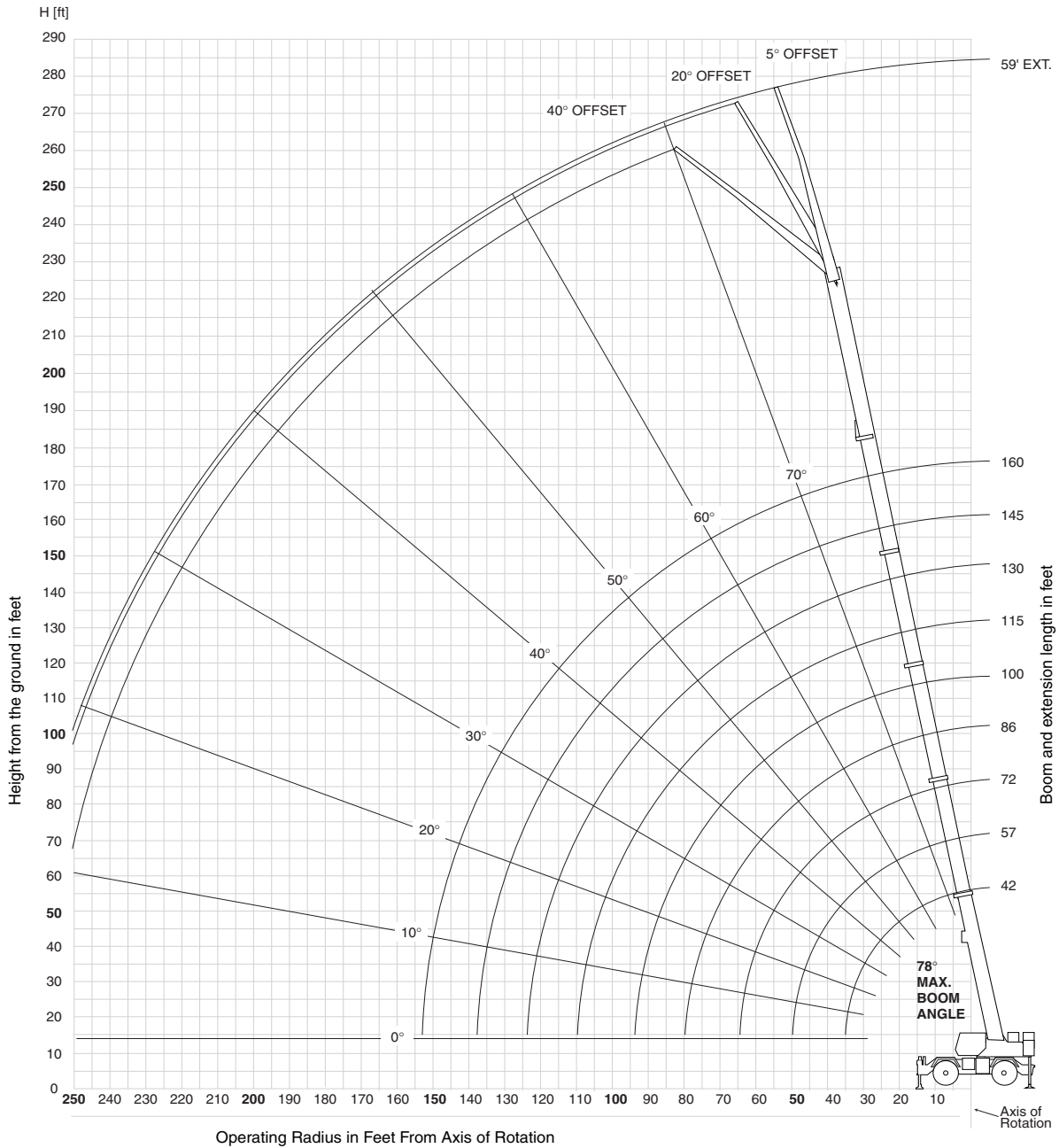

Dimensions are for Largest Grove furnished Hook Block and Headache Ball, with Anti-Two Block Activated.

THIS CHART IS ONLY A GUIDE AND SHOULD NOT BE USED TO OPERATE THE CRANE. The individual crane's load chart, operating instructions and other instructional plates must be read and understood prior to operating the crane.

RT9130E

36-59 ft. luffing folding boom extension (fixed angle) 100 ft. main boom



100 ft. 36 - 59 ft. 40,000 lbs 100% 360°
27' 10" spread

16

Feet	Pounds					
	36 ft. LENGTH			59 ft. LENGTH		
	5° OFFSET	20° OFFSET	40° OFFSET	5° OFFSET	20° OFFSET	40° OFFSET
	#0091			#0092		
30	32,600 (78)					
35	30,700 (76)	*23,150 (78)				
40	28,950 (74)	22,150 (76.5)		14,950 (77.5)		
45	27,350 (71.5)	21,250 (74)	15,250 (78)	14,950 (75.5)		
50	25,900 (69.5)	20,450 (72)	14,850 (75.5)	14,950 (73.5)	12,350 (78)	
55	24,600 (67)	19,700 (69.5)	14,500 (73)	14,550 (72)	11,900 (77)	
60	23,400 (64.5)	19,050 (67)	14,200 (70.5)	14,150 (70)	11,500 (75)	
65	22,300 (62)	18,450 (65)	13,900 (68)	13,750 (68)	11,100 (73)	8,050 (78)
70	21,300 (59.5)	17,850 (62)	13,650 (65.5)	13,350 (66)	10,700 (71)	7,850 (76)
75	20,100 (57)	17,350 (59.5)	13,450 (63)	13,000 (64)	10,400 (69)	7,660 (73.5)
80	18,100 (54.5)	16,900 (57)	13,300 (60)	12,550 (61.5)	10,050 (66.5)	7,490 (71.5)
85	16,000 (51.5)	16,500 (54)	13,150 (57)	12,000 (59.5)	9,780 (64.5)	7,340 (69)
90	14,150 (49)	15,400 (51.5)	13,050 (54)	11,550 (57.5)	9,510 (62.5)	7,210 (66.5)
95	12,500 (46)	13,700 (48)	13,000 (50.5)	11,100 (55)	9,260 (60)	7,090 (64)
100	11,050 (42.5)	12,100 (45)	12,750 (47)	10,650 (52.5)	9,030 (57.5)	6,980 (61.5)
105	9,770 (39)	10,650 (41.5)		10,250 (50)	8,820 (55)	6,900 (59)
110	8,490 (35.5)	9,270 (37.5)		9,930 (47.5)	8,620 (52.5)	6,830 (56)
115	7,400 (31)	8,060 (33)		9,040 (45)	8,440 (49.5)	6,790 (53)
120	6,320 (26)	6,850 (28)		8,150 (42)	8,260 (47)	6,750 (50)
125				7,240 (39)	7,820 (43.5)	
130				6,340 (35.5)	7,380 (40.5)	
135				5,570 (32)	6,440 (36.5)	
140				4,800 (28)	5,510 (32)	
145				4,100 (23)		
150				3,410 (16)		
Min. boom angle for indicated length (no load)	5°	20°	40°	5°	20°	40°
Max. boom length at 5° boom angle (no load)	100 ft.			100 ft.		

NOTE: () Boom angles are in degrees.
#LMI operating code. Refer to LMI manual for operating instructions.
*This capacity is based on maximum obtainable boom angle.

A6-829-102550

NOTES:

- All capacities above the bold line are based on structural strength of boom extension.
- 36 ft. boom extension may be used for single or double line lifting service. 59 ft. boom extension may be used for single line lifting service only.
WARNING: Lifting with the 36 ft. extension base, with the 23 ft. extension fly either erected or folded along side of extension base, is strictly prohibited.
- Radii listed are for a 100 ft. boom with the boom extension erected. For main boom lengths less than 100 ft., the rated loads are determined by boom angle. Use only the column which corresponds to the boom extension length and offset for which the machine is configured. For boom angles not shown, use the rating of the next lower boom angle.
WARNING: Operation of this machine with heavier loads than the capacities listed is strictly prohibited. Machine tipping with boom extension occurs rapidly and without advance warning.
- Boom angle is the angle above or below horizontal of the longitudinal axis of the boom base section after lifting rated load.
- Capacities listed are with outriggers properly extended and vertical jacks set only.

RT9130E

THIS CHART IS ONLY A GUIDE AND SHOULD NOT BE USED TO OPERATE THE CRANE. The individual crane's load chart, operating instructions and other instructional plates must be read and understood prior to operating the crane.

36-59 ft. luffing folding boom extension (fixed angle) 130 ft. main boom



130 ft. 36 - 59 ft. 40,000 lbs 100% 27' 10" spread 360°

Pounds						
Feet	36 ft. LENGTH			59 ft. LENGTH		
	5° OFFSET	20° OFFSET	40° OFFSET	5° OFFSET	20° OFFSET	40° OFFSET
	#0091			#0092		
40	*23,350 (78)					
45	23,350 (76)	*21,300 (78)		*12,300 (78)		
50	23,350 (74)	20,700 (76.5)		12,300 (77.5)		
55	23,350 (72.5)	20,100 (75)	14,850 (78)	12,300 (76)		
60	23,350 (70.5)	19,500 (73)	14,550 (76)	12,300 (74.5)	11,600 (78)	
65	22,300 (68.5)	19,000 (71)	14,300 (74)	12,300 (73)	11,300 (77)	
70	20,350 (66.5)	18,500 (69)	14,050 (72)	12,300 (71)	10,950 (75)	
75	18,350 (64.5)	18,050 (67)	13,850 (70)	12,300 (69.5)	10,700 (73.5)	7,850 (78)
80	16,600 (62.5)	17,000 (65)	13,650 (68)	12,300 (68)	10,400 (72)	7,690 (76)
85	15,050 (60.5)	15,450 (63)	13,450 (66)	12,300 (66)	10,150 (70)	7,550 (74.5)
90	13,650 (58.5)	14,050 (61)	13,300 (63.5)	12,250 (64.5)	9,910 (68.5)	7,420 (72.5)
95	12,400 (56.5)	12,800 (58.5)	13,150 (61.5)	11,900 (62.5)	9,680 (66.5)	7,300 (70.5)
100	11,300 (54)	11,650 (56.5)	11,950 (59)	11,450 (61)	9,460 (64.5)	7,190 (68.5)
105	10,300 (52)	10,650 (54)	10,950 (56.5)	10,500 (59)	9,260 (63)	7,090 (66.5)
110	9,340 (49.5)	9,660 (52)	9,950 (54)	9,580 (57)	9,060 (61)	7,000 (64.5)
115	8,480 (47)	8,810 (49.5)	9,070 (51.5)	8,790 (55)	8,800 (59)	6,930 (62.5)
120	7,630 (44.5)	7,970 (46.5)	8,200 (48.5)	8,010 (53)	8,550 (57)	6,860 (60.5)
125	6,700 (41.5)	7,240 (44)	7,430 (45.5)	7,340 (51)	7,840 (54.5)	6,810 (58)
130	5,780 (39)	6,510 (41)	6,670 (42.5)	6,680 (49)	7,140 (52.5)	6,770 (55.5)
135	4,980 (35.5)	5,690 (37.5)		6,100 (46.5)	6,520 (50.5)	6,500 (53.5)
140	4,190 (32)	4,880 (34)		5,520 (44)	5,910 (48)	6,240 (50.5)
145	3,500 (28)	4,120 (30)		4,860 (42)	5,360 (45.5)	5,640 (48)
150	2,820 (23.5)	3,360 (25.5)		4,200 (39)	4,820 (42.5)	5,050 (45)
155				3,580 (36.5)	4,280 (40)	
160				2,970 (33.5)	3,750 (36.5)	
165				2,430 (30)	3,120 (33)	
170				1,890 (26)	2,490 (29)	
Min. boom angle for indicated length (no load)	20°	20°	40°	20°	20°	40°
Max. boom length at 5° boom angle (no load)	100 ft.			100 ft.		

NOTE: () Boom angles are in degrees. A6-829-102554
 #LMI operating code. Refer to LMI manual for operating instructions.
 *This capacity is based on maximum obtainable boom angle.

- NOTES:**
- All capacities above the bold line are based on structural strength of boom extension.
 - 36 ft. boom extension may be used for single or double line lifting service. 59 ft. boom extension may be used for single line lifting service only. **WARNING:** Lifting with the 36 ft. extension base, with the 23 ft. extension fly either erected or folded along side of extension base, is strictly prohibited.
 - Radii listed are for a 130 ft. boom with the boom extension erected. For main boom lengths less than 130 ft., the rated loads are determined by boom angle. Use only the column which corresponds to the boom extension length and offset for which the machine is configured. For boom angles not shown, use the rating of the next lower boom angle. **WARNING:** Operation of this machine with heavier loads than the capacities listed is strictly prohibited. Machine tipping with boom extension occurs rapidly and without advance warning.
 - Boom angle is the angle above or below horizontal of the longitudinal axis of the boom base section after lifting rated load.
 - Capacities listed are with outriggers properly extended and vertical jacks set only.

THIS CHART IS ONLY A GUIDE AND SHOULD NOT BE USED TO OPERATE THE CRANE. The individual crane's load chart, operating instructions and other instructional plates must be read and understood prior to operating the crane.

36-59 ft. luffing folding boom extension (fixed angle) 160 ft. main boom



18

Pounds						
Feet	36 ft. LENGTH #0091			59 ft. LENGTH #0092		
	5° OFFSET	20° OFFSET	40° OFFSET	5° OFFSET	20° OFFSET	40° OFFSET
50	15,550 (77.5)					
55	15,550 (76)					
60	15,550 (74.5)	14,950 (77.5)		9,650 (78)		
65	15,550 (73)	14,950 (76)	*14,400 (78)	9,650 (77)		
70	15,550 (71.5)	14,950 (74.5)	14,150 (77)	9,650 (75.5)	9,650 (78)	
75	14,900 (70)	14,250 (73)	13,950 (75.5)	9,650 (74)	9,650 (77.5)	
80	14,100 (68)	13,550 (71)	13,400 (74)	9,650 (72.5)	9,650 (76)	
85	13,400 (66.5)	12,900 (69.5)	12,800 (72)	9,650 (71)	9,650 (74.5)	7,630 (78)
90	12,700 (65)	12,250 (68)	12,200 (70.5)	9,650 (69.5)	9,650 (73)	7,510 (77.5)
95	11,500 (63)	11,700 (66)	11,650 (68.5)	9,650 (68.5)	9,650 (72)	7,390 (75.5)
100	10,400 (61.5)	10,850 (64.5)	11,100 (67)	9,570 (67)	9,420 (70)	7,290 (74)
105	9,480 (59.5)	9,910 (62.5)	10,200 (65)	9,150 (65)	9,010 (68.5)	7,200 (72.5)
110	8,570 (58)	8,970 (61)	9,360 (63)	8,730 (63.5)	8,610 (67)	7,110 (71)
115	7,780 (56)	8,160 (59)	8,530 (61)	8,000 (62)	8,220 (65.5)	7,030 (69.5)
120	6,990 (54)	7,360 (57)	7,700 (59)	7,280 (60.5)	7,840 (64)	6,950 (67.5)
125	6,320 (52)	6,670 (55)	6,980 (57)	6,620 (59)	7,180 (62.5)	6,890 (66)
130	5,650 (50)	5,980 (53)	6,260 (55)	5,970 (57.5)	6,530 (60.5)	6,830 (64)
135	5,070 (48)	5,380 (51)	5,630 (53)	5,400 (55.5)	5,930 (59)	6,320 (62.5)
140	4,500 (46)	4,780 (49)	5,010 (50.5)	4,830 (54)	5,340 (57)	5,820 (60.5)
145	3,990 (43.5)	4,250 (46.5)	4,450 (48)	4,340 (52)	4,820 (55.5)	5,260 (58.5)
150	3,490 (41.5)	3,730 (44)	3,900 (45.5)	3,850 (50)	4,300 (53.5)	4,710 (56.5)
155	2,990 (38.5)	3,260 (41.5)		3,410 (48)	3,840 (51.5)	4,210 (54.5)
160	2,490 (36)	2,800 (38.5)		2,980 (46)	3,380 (49.5)	3,710 (52)
165	1,970 (33)	2,300 (36)		2,590 (44)	2,960 (47.5)	3,250 (50)
170	1,450 (30)	1,800 (32.5)		2,210 (42)	2,550 (45)	2,790 (47.5)
175				1,800 (39.5)	2,170 (43)	
180				1,390 (37.5)	1,800 (40)	
185					1,420 (37.5)	
Min. boom angle for indicated length (no load)	26°	29°	40°	34°	36°	40°
Max. boom length at 5° boom angle (no load)		100 ft.			100 ft.	

NOTE: () Boom angles are in degrees.
 #LMI operating code. Refer to LMI manual for operating instructions.
 *This capacity is based on maximum obtainable boom angle.

NOTES:

- All capacities above the bold line are based on structural strength of boom extension and do not exceed 85% of tipping loads, in accordance with SAE J765.
- 36 ft. boom extension may be used for single or double line lifting service. 59 ft. boom extension may be used for single line lifting service only.
WARNING: Lifting with the 36 ft. extension base, with the 23 ft. extension fly either erected or folded along side of extension base, is strictly prohibited.
- Radii listed are for a 160 ft. boom with the boom extension erected. For main boom lengths less than 160 ft., the rated loads are determined by boom angle. Use only the column which corresponds to the boom extension length and offset for which the machine is configured. For boom angles not shown, use the rating of the next lower boom angle.
WARNING: Operation of this machine with heavier loads than the capacities listed is strictly prohibited. Machine tipping with boom extension occurs rapidly and without advance warning.
- Boom angle is the angle above or below horizontal of the longitudinal axis of the boom base section after lifting rated load.
- Capacities listed are with outriggers properly extended and vertical jacks set only.

RT9130E

THIS CHART IS ONLY A GUIDE AND SHOULD NOT BE USED TO OPERATE THE CRANE. The individual crane's load chart, operating instructions and other instructional plates must be read and understood prior to operating the crane.

59 ft. luffing folding boom extension w/ (1) or (2) inserts (fixed angle) 160 ft. main boom

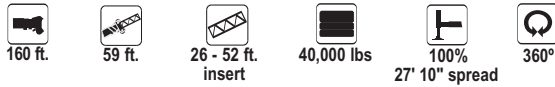

Pounds						
Feet	59 ft. LENGTH WITH 26 ft. INSERT #0095			59 ft. LENGTH WITH 52 ft. INSERT #1095		
	5° OFFSET	20° OFFSET	40° OFFSET	5° OFFSET	20° OFFSET	40° OFFSET
70	6,830 (78)					
75	6,830 (77)			4,400 (78)		
80	6,830 (75.5)	6,610 (78)		4,400 (77.5)		
85	6,830 (74.5)	6,610 (77.5)		4,400 (76.5)		
90	6,830 (73)	6,610 (76)		4,400 (75.5)	4,230 (78)	
95	6,830 (72)	6,610 (75)	6,400 (78)	4,400 (74.5)	4,230 (77.5)	
100	6,830 (70.5)	6,610 (73.5)	6,400 (77)	4,400 (73)	4,230 (76.5)	
105	6,830 (69.5)	6,610 (72.5)	6,400 (76)	4,400 (72)	4,230 (75.5)	4,000 (78)
110	6,830 (68)	6,610 (71)	6,400 (74.5)	4,400 (71)	4,230 (74)	4,000 (77)
115	6,590 (66.5)	6,520 (69.5)	6,310 (73)	4,400 (69.5)	4,230 (73)	4,000 (75.5)
120	6,350 (65)	6,430 (68)	6,230 (71.5)	4,400 (68.5)	4,230 (72)	4,000 (74.5)
125	5,910 (64)	6,120 (67)	5,950 (70)	4,400 (67.5)	4,230 (70.5)	4,000 (73)
130	5,480 (62.5)	5,810 (65.5)	5,680 (68.5)	4,400 (66)	4,230 (69.5)	4,000 (72)
135	4,930 (61)	5,480 (64)	5,430 (67)	4,110 (65)	4,170 (68)	4,000 (70.5)
140	4,380 (59.5)	5,160 (62.5)	5,190 (65.5)	3,820 (63.5)	4,120 (67)	4,000 (69)
145	3,900 (58)	4,640 (61)	4,900 (64)	3,350 (62.5)	3,860 (65.5)	3,780 (68)
150	3,420 (56.5)	4,130 (59.5)	4,620 (62.5)	2,880 (61)	3,610 (64)	3,570 (66.5)
155	3,000 (55)	3,680 (58)	4,140 (60.5)	2,470 (59.5)	3,200 (63)	3,360 (65)
160	2,580 (53.5)	3,230 (56.5)	3,660 (59)	2,060 (58.5)	2,800 (61.5)	3,160 (63.5)
165	2,210 (52)	2,820 (54.5)	3,220 (57.5)	1,690 (57)	2,400 (60)	2,810 (62.5)
170	1,840 (50)	2,420 (53)	2,780 (55.5)		2,010 (59)	2,460 (61)
175	1,510 (48.5)	2,060 (51)	2,380 (53.5)		1,650 (57.5)	2,070 (59.5)
180		1,700 (49.5)	1,990 (51.5)			1,690 (58)

Min. boom angle (°) for indicated length (no load) 46° 46° 48° 55° 56° 56°
 Max. boom length at 5° boom angle (no load) 57 ft. 57 ft.

NOTE: () Boom angles are in degrees. A6-829-102562
 #LMI operating code. Refer to LMI manual for operating instructions.

NOTES:

- All capacities above the bold line are based on structural strength of boom extension and do not exceed 85% of tipping loads, in accordance with SAE J-765.
- 59 ft. folding boom extension length may be used for single line lifting service only.
NOTE: Lifting with the 36 ft. extension base with either one or two 26 ft. insert sections installed is not permitted.
- For main boom lengths less than 160 ft. with the boom extension erected, the rated loads are determined by boom angle. Use only the column which corresponds to the boom extension length and offset for which the machine is set up. For boom angles not shown, use the rating of the next lower boom angle.
- WARNING:** Operation of this machine with heavier loads than the capacities listed is strictly prohibited. Machine tipping with boom extension occurs rapidly and without advance warning.
- Boom angle is the angle above or below horizontal of the longitudinal axis of the boom base section after lifting rated load.
- Capacities listed are with outriggers properly extended and vertical jacks set only.

36-59 ft. luffing folding boom extension 160 ft. main boom (Load Luffing)



20

Pounds				
Feet	36 ft. LENGTH		59 ft. LENGTH	
	5° - 20° OFFSET #0091	20° - 40° OFFSET	5° - 20° OFFSET #0092	20° - 40° OFFSET
60	14,950			
65	14,950	10,250		
70	14,950	10,050	9,650	
75	14,250	9,840	9,320	
80	13,550	9,640	8,950	
85	12,900	9,460	8,600	5,100
90	12,250	9,280	8,290	4,980
95	11,500	9,130	7,990	4,880
100	10,400	8,980	7,720	4,780
105	9,480	8,850	7,470	4,690
110	8,570	8,720	7,220	4,600
115	7,780	8,160	7,010	4,520
120	6,990	7,360	6,790	4,440
125	6,320	6,670	6,600	4,370
130	5,650	5,980	5,970	4,310
135	5,070	5,380	5,400	4,250
140	4,500	4,780	4,830	4,200
145	3,990	4,250	4,340	4,160
150	3,490	3,730	3,850	4,120
155	2,990		3,410	3,840
160	2,490		2,980	3,380
165	1,970		2,590	2,960
170	1,450		2,210	2,550
175			1,800	
180			1,390	
Min. boom angle for indicated length (no load)	29°	40°	36°	40°
Max. boom length at 5° boom angle (no load)	100 ft.		100 ft.	

#LMI operating code. Refer to LMI manual for operating instructions.

A6-829-102575

NOTES:

1. All capacities above the bold line are based on structural strength of boom extension and do not exceed 85% of tipping loads, in accordance with SAE J-765.
2. 36 ft. boom extension length may be used for single or double line lifting service. 59 ft. boom extension may be used for single line lifting service only.
WARNING: Lifting with the 36 ft. extension base, with the 23 ft. extension fly either erected or folded along side of extension base, is strictly prohibited.
3. Capacities are applicable for a 160 ft. main boom length only.
WARNING: Operation of this machine with heavier loads than the capacities listed is strictly prohibited. Machine tipping with boom extension occurs rapidly and without advance warning.
4. The loads for luffing depend on the angle of the main boom, angle of the boom extension and dynamic working pressure of the luffing cylinder for the boom extension.
5. Capacities listed are with outriggers properly extended and vertical jacks set only.

RT9130E

59 ft. luffing folding boom extension w/ (1) or (2) inserts 160 ft. main boom (Load Luffing)



Pounds				
Feet	59 ft. LENGTH with 26 ft. INSERT		59 ft. LENGTH with 52 ft. INSERT	
	5° - 20° OFFSET	20° - 40° OFFSET	5° - 20° OFFSET	20° - 40° OFFSET
	#0095		#1095	
80	6,610			
85	6,610			
90	6,610		4,230	
95	6,610	4,420	4,230	
100	6,610	4,330	4,230	
105	6,610	4,250	4,230	4,000
110	6,430	4,180	4,230	4,000
115	6,250	4,100	4,230	4,000
120	6,070	4,020	4,230	4,000
125	5,900	3,970	4,230	4,000
130	5,480	3,920	4,230	4,000
135	4,930	3,870	4,110	4,000
140	4,380	3,810	3,820	3,960
145	3,900	3,770	3,350	3,780
150	3,420	3,730	2,880	3,570
155	3,000	3,680	2,470	3,200
160	2,580	3,230	2,060	2,800
165	2,210	2,820	1,690	2,400
170	1,840	2,420		2,010
175	1,510	2,060		1,650
180		1,700		
Min. boom angle for indicated length (no load)	46°	48°	56°	56°
Max. boom length at 5° boom angle (no load)	57 ft.		57 ft.	

#LMI operating code. Refer to LMI manual for operating instructions.

A6-829-102579

NOTES:

1. All capacities above the bold line are based on structural strength of boom extension and do not exceed 85% of tipping loads, in accordance with SAE J-765.
2. 59 ft. boom extension may be used for single line lifting service only.
WARNING: Lifting with the 36 ft. extension base, with either one or two 26 ft. insert sections installed is not permitted.
3. Capacities are applicable for a 160 ft. main boom length only.
WARNING: Operation of this machine with heavier loads than the capacities listed is strictly prohibited. Machine tipping with boom extension occurs rapidly and without advance warning.
4. The loads for luffing depend on the angle of the main boom, angle of the boom extension and dynamic working pressure of the luffing cylinder for the boom extension.
5. Capacities listed are with outriggers properly extended and vertical jacks set only.

Installation and Removal of Counterweight and Auxiliary Hoist Rated Lifting Capacities in Pounds

22

On Outriggers Fully Extended – 360°	
Radius in Feet	#0801 Main Boom Length 42 ft*
10	48,000
12	48,000
15	48,000
20	48,000
25	48,000
30	48,000

Installation and Removal of Front and Rear Outrigger Boxes Rated Lifting Capacities in Pounds without Counterweight

On Rubber (Stationary) – 360°	
Radius in Feet	#9810 Main Boom Length 42 ft*
10	11,600
12	11,600
15	11,600
20	11,600

**The boom must be fully retracted.*

Notes for On Rubber

- Capacities are applicable to machines equipped with General 33.25 x 29 (38 ply) tires at 85 psi cold inflation pressure or Michelin 29.5R29 tires at 90 psi cold inflation pressure. Capacities do not exceed 75% of tipping loads as determined by test in accordance with SAE J765.
- With no load, the boom angle must not be less than 35° when over sides of machine since loss of stability will occur causing a tipping condition. To lower boom below 35° boom angle, boom must be swung over front or rear and LMI bypass activated.
- Once one outrigger box is installed, do not swing over that end of the machine while installing the other outrigger box.
- Each outrigger box assembly weighs 9373 lb. including the outrigger beams and pads.
- May be used for single or double line lifting service.

RT9130E

load handling

23

Weight Reductions for Load Handling Devices

36-59 Ft. Luffing Folding Boom Extension	Pounds
*36 ft. Extension (Erected)	5,260
*59 ft. Extension (Erected)	9,860
Luffing Extension with 26 ft. Insert	
*59 ft. Extension (Erected)	14,100
Luffing Extension with 52 ft. Insert	
*59 ft. Extension (Erected)	19,400

*Reduction of main boom capacities
(No deduct required for stowed boom extension)

When lifting over main boom nose with 36 ft. or 59 ft. extension erected, the outriggers must be fully extended or 50% extended (19' 9" spread).

When lifting over main boom nose with 26 ft. or 52 ft. insert erected, the outriggers must be fully extended.

Auxiliary Boom Nose	Pounds
	120
Hookblocks and Headache Balls	
80 Ton, 5 Sheave	1,600+
130 Ton, 8 Sheave	2,400+
10 Ton Overhaul Ball	690+

+Refer to rating plate for actual weight.

When lifting over swingaway and/or jib combinations, deduct total weight of all load handling devices reeved over main boom nose directly from swingaway or jib capacity.

NOTE: All load handling devices and boom attachments are considered part of the load and suitable allowances MUST BE MADE for their combined weights. Weights are for Grove furnished equipment.

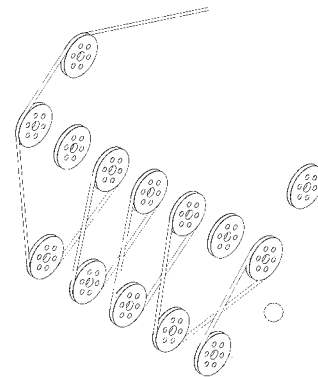

Line Pulls and Reeving Information

Hoists	Cable Specs	Permissible Line Pulls	Nominal Cable Length
Main Model 35	3/4" (19 mm) 6x37 Class EIPS, IWRC Special Flexible	16,800 lb.	950 ft.
	Min. Breaking Str. 58,800 lb.		
Main Model 35	3/4" (19 mm) Flex - X 35	16,800 lb.	950 ft.
	Rotation Resistance (non-rotating) Min. Breaking Strength 85,500 lb.		
Auxiliary Model 35	3/4" (19 mm) Flex - X 35	16,800 lb.	700 ft.
	Rotation Resistance (non-rotating) Min. Breaking Strength 85,500 lb.		

The approximate weight of 3/4" wire rope is 1.5 lb./ft.

Hoist Performance

Wire Rope Layer	Hoist Line Pulls Two Speed Hoist		Drum Rope Capacity (ft.)	
	Low Available lb.*	High Available lb.*	Layer	Total
1	19,267	11,094	136	136
2	17,709	10,197	148	284
3	16,384	9,434	160	445
4	15,243	8,777	172	618
5	14,251	8,206	184	802
6	13,380	7,705	196	998

*Max. lifting capacity: 6x37 or 35x7 class = 16,800 lb.

Working Area Diagram

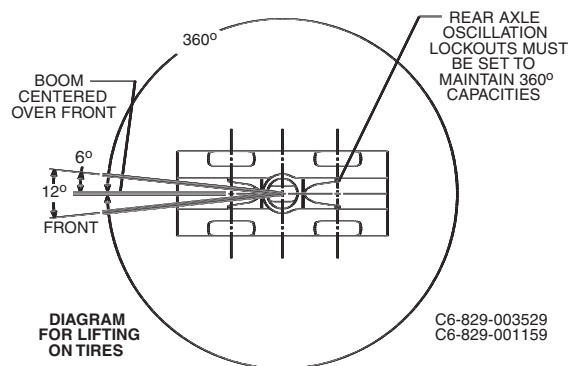
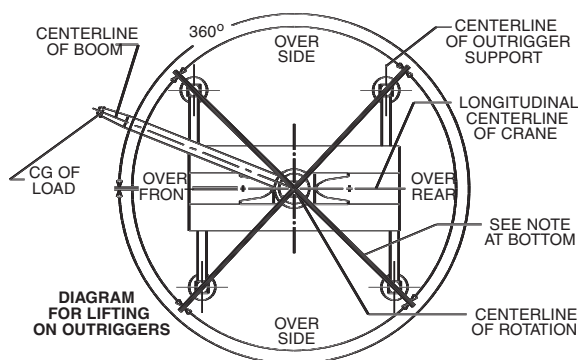

Bold lines determine the limiting position of any load for operation within working areas indicated.

THIS CHART IS ONLY A GUIDE AND SHOULD NOT BE USED TO OPERATE THE CRANE. The individual crane's load chart, operating instructions and other instructional plates must be read and understood prior to operating the crane.

RT9130E

Regional Headquarters

Americas

Manitowoc, Wisconsin, USA

Tel: +1 920 684 6621

Fax: +1 920 683 6278

Shady Grove, Pennsylvania, USA

Tel: +1 717 597 8121

Fax: +1 717 597 4062

Regional Offices

Americas

Brazil

Alphaville

Tel: +55 11 4688 2716

Fax: +55 11 4191 1471

Mexico

Monterrey

Tel: +52 81 8124 0128

Fax: +52 81 8124 0129

Europe, Middle East, Africa

Algeria

Hydra

Tel: +21 3 21 48 1173

Fax: +21 3 21 48 1454

Czech Republic

Netvorice

Tel: +420 317 78 9313

Fax: +420 317 78 9314

France

Baudemont

Tel: +33 385 28 2589

Fax: +33 385 28 0430

Cergy

Tel: +33 130 31 3150

Fax: +33 130 38 6085

Decines

Tel: +33 472 81 5000

Fax: +33 472 81 5010

Germany

Langenfeld

Tel: +49 21 73 8909-0

Fax: +49 21 73 8909 30

Hungary

Budapest

Tel: +36 13 39 8622

Fax: +36 13 39 8622

Italy

Parabiago

Tel: +390 331 49 3311

Fax: +390 331 49 3330

Europe, Middle East, Africa

Ecully, France

Tel: +33 472 18 2020

Fax: +33 472 18 2000

Netherlands

Breda

Tel: +31 76 578 3999

Fax: +31 76 578 3978

Poland

Warsaw

Tel: +48 22 843 3824

Fax: +48 22 843 3471

Portugal

Alfena

Tel: +351 229 69 8840

Fax: +351 229 69 8848

Lisbon

Tel: +351 212 109 340

Fax: +351 212 109 349

Russia

Moscow

Tel: +7 495 641 2359

Fax: +7 495 641 2358

U.A.E.

Dubai

Tel: +971 4 3381 861

Fax: +971 4 3382 343

U. K.

Middlesex

Tel: +44 1 895 43 0053

Fax: +44 1 895 45 9500

Sunderland

Tel: +44 191 522 2000

Fax: +44 191 522 2052

Asia – Pacific

Australia

Melbourne

Tel: +61 3 9 336 1300

Fax: +61 3 9 336 1322

Sydney

Tel: +61 2 9 896 4433

Fax: +61 2 9 896 3122

Asia – Pacific

Shanghai, China

Tel: +86 21 51113579

Fax: +86 21 51113578

Singapore

Tel: +65 6264 1188

Fax: +65 6862 4142

China

Beijing

Tel: +86 10 58674761

Fax: +86 10 58674760

Xi'an

Tel: +86 29 87891465

Fax: +86 29 87884504

Korea

Seoul

Tel: +82 2 3439 0400

Fax: +82 2 3439 0405

Philippines

Makati City

Tel: +63 2 844 9437

Fax: +63 2 844 4712

Factories

U.S.A.

Manitowoc

Shady Grove

Brazil

Alphaville

France

Charlieu

La Clayette

Moulines

India

Calcutta

Puna

Italy

Niella Tanaro

Germany

Wilhelmshaven

Portugal

Fânzeres

China

Zhangjiagang



Constant improvement and engineering progress make it necessary that we reserve the right to make specification, equipment and price changes without notice. Illustrations shown may include optional equipment and accessories, and may not include all standard equipment.