

# RT765E-2

## Product Guide

Ansi B30.5  
Imperial 85%



### Features

- 60 t (65 USt) capacity
- 11 m – 33,5 m (36 ft – 110 ft) four-section full power boom
- 10,1 m - 17,1 m (33 ft - 56 ft) bi-fold lattice swingaway extension
- 12,2 m (40 ft) lattice extension inserts
- 6516 kg (14,365 lb) counterweight pinned to superstructure
- 4X4 with four modes of steering

# GROVE RT765E-2

This 60 t (65 USt) capacity rough-terrain crane combines the MEGAFORM™ boom shape with full-power capability. With four-wheel multi-mode steering, and the Full Vision cab optimize mobility and operator confidence on the jobsite.

## Features

### > MEGAFORM™ boom

The superstructure features a full-power four-section MEGAFORM™ boom that can reach a maximum tip height of 36,4 m (119 ft). The sequence synchronized extension features telescopic boom sections via a pedal or single lever control.



### > Extensions

An optional bi-fold swingaway lattice extension easily stows on the side of the base boom for easy transport while providing on-board extension from 10,1 m - 17,1 m (33 ft - 56 ft) for a maximum tip height of 53,2 m (174.5 ft). By adding inserts of 6,1 m (20 ft) or 12,2 m (40 ft), the maximum tip height on the RT765E-2 can be extended even further to 59,1 m (194 ft) or 65,2 m (214 ft).



### > Smooth operation

The RT765E-2 has a quick-reeve boom nose and swingaway alignment device to help operators set up smoothly.



### > CraneSTAR is an exclusive and innovative crane asset management system

that helps improve your profitability and reduce costs by remotely monitoring critical crane data.

Visit [www.cranestar.com](http://www.cranestar.com) for more information.

## Jobsite benefits

### > Exceptional maneuverability

Maneuvering around the job site is easier with Grove rough-terrain cranes. Four-wheel drive combined with four modes of steering (front only, rear only, crab and coordinated) allows operators to get closer to the lift regardless of congested areas or adverse ground conditions. All modes are controlled through steering wheel and rocker switches, so there's no need for operators to stop and align the wheels.

### > Jobsite flexibility means more lifts for greater profitability

Grove rough-terrain cranes can be reconfigured to fit numerous lifting applications, giving you more lifting versatility. That provides you with the potential to win more jobs for greater profitability and return on investment.

### > Innovation drives enhanced operation and efficiency

Grove utilizes the latest technology to provide the highest work efficiency and safety — all while meeting today's strict environmental standards. Our innovations ensure reliable crane performance along with operator productivity and comfort.



**Manitowoc Crane Care when you need it.**  
The assurance of the world's most advanced crane service and support to get you back to work fast.



**Manitowoc Finance helps you get right to work generating profits for your business.**  
Financial tools that help you capitalize on opportunity with solutions that fit your needs.

# Contents

Dimensions and weights	5
Working range	6
Load charts	9
Load handling	15
Specifications	16
Symbols glossary	18

# Dimensions and Weights

## Dimensions

Tire size	A	B	C	D	E	F	G	A	B	C	D	E	F	G	H
29.5-2.5	14 961 mm (589")	15 368 mm (605")	12 460 mm (491")	11 732 mm (462")	11 342 mm (446")	9 004 mm (355")	7 662 mm (302")	10 922 m (430")	11 153 mm (439")	7 830 mm (308")	7 099 mm (280")	6 744 mm (266")	4 368 mm (172")	3 496 mm (138")	2 499 mm (98.37")
2 Wheel Steer								4 Wheel Steer							

Dimensions for table are represented in millimeters (inches), exact.

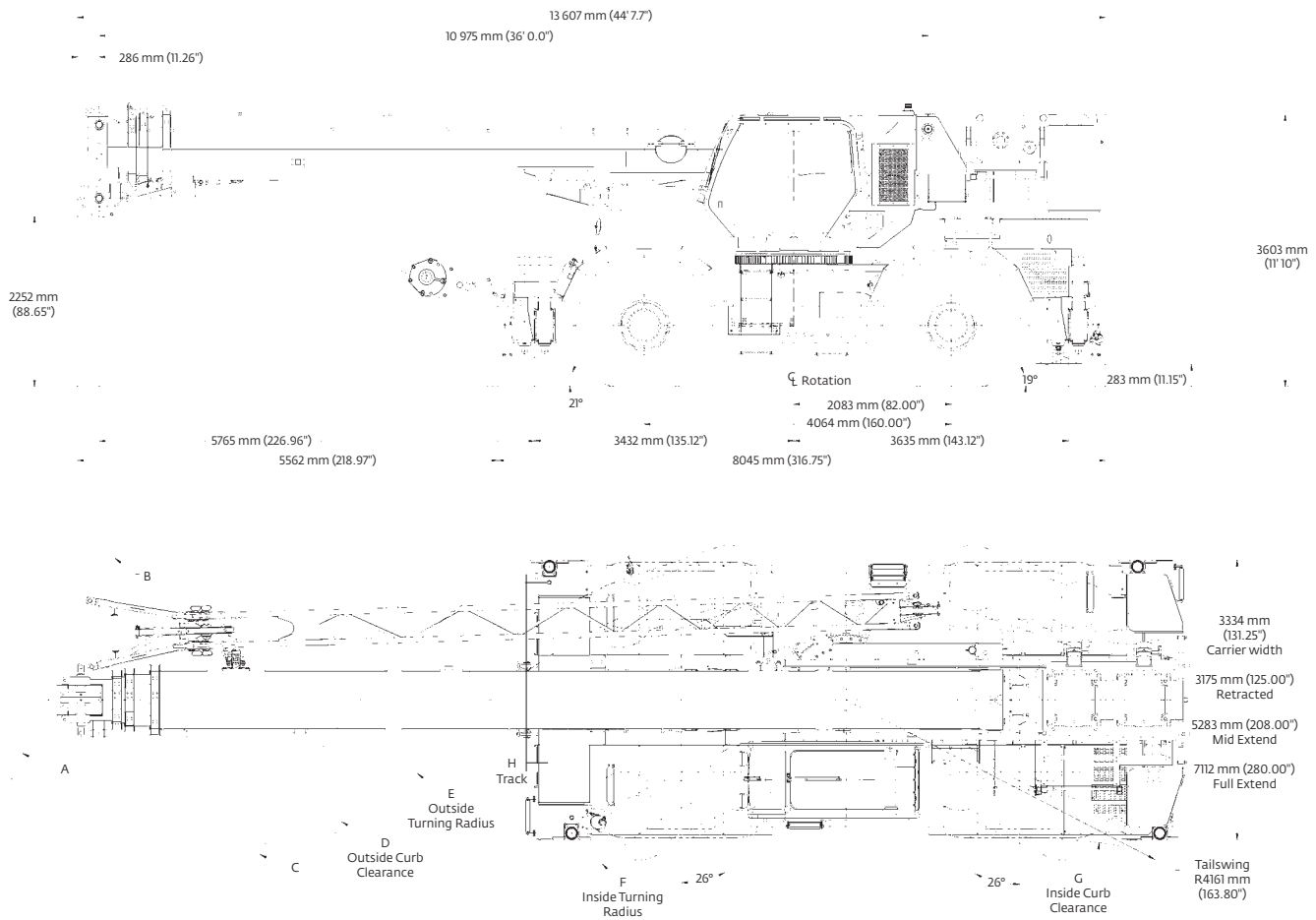

	Gross		Front		Rear	
	kg	lb	kg	lb	kg	lb
<b>Basic Machine:</b> (T4F) Including 33,5 m (110 ft) main boom, main hoist with 152 m (500 ft) of wire rope, auxiliary hoist with 152 m (500 ft) of wire rope, full pinned counterweight, full Decking, A/C, and hoist access platform	40 529	89,349	18 371	40,501	22 157	48,848
<b>ADD:</b> 10,1 m - 17,1 m (33 ft -56 ft) bi-fold swingaway + extension carrier brackets + aux. boom nose	1324	2918	2168	4779	-844	-1861
<b>Crane Weight</b>	41 852	92,267	20 539	45,280	21 313	46,987
<b>ADD:</b> 60 t (66 USt) 5-sheave hook block stowed in trough	580	1280	580	1280	0	0
<b>Crane Weight</b>	42 433	93,547	21 120	46,560	21 313	46,987
<b>ADD:</b> 7,5 t (8.3 USt) headache ball tied to O/R cable	161	355	262	578	-101	-223
<b>Crane Weight</b>	42 594	93,902	21 382	47,138	21 212	46,764

# Working range

110 ft main boom with 33 ft - 56 ft bi-fold swingaway

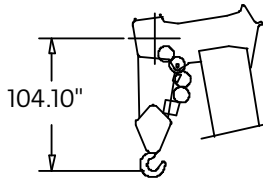
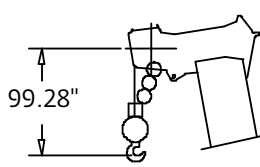
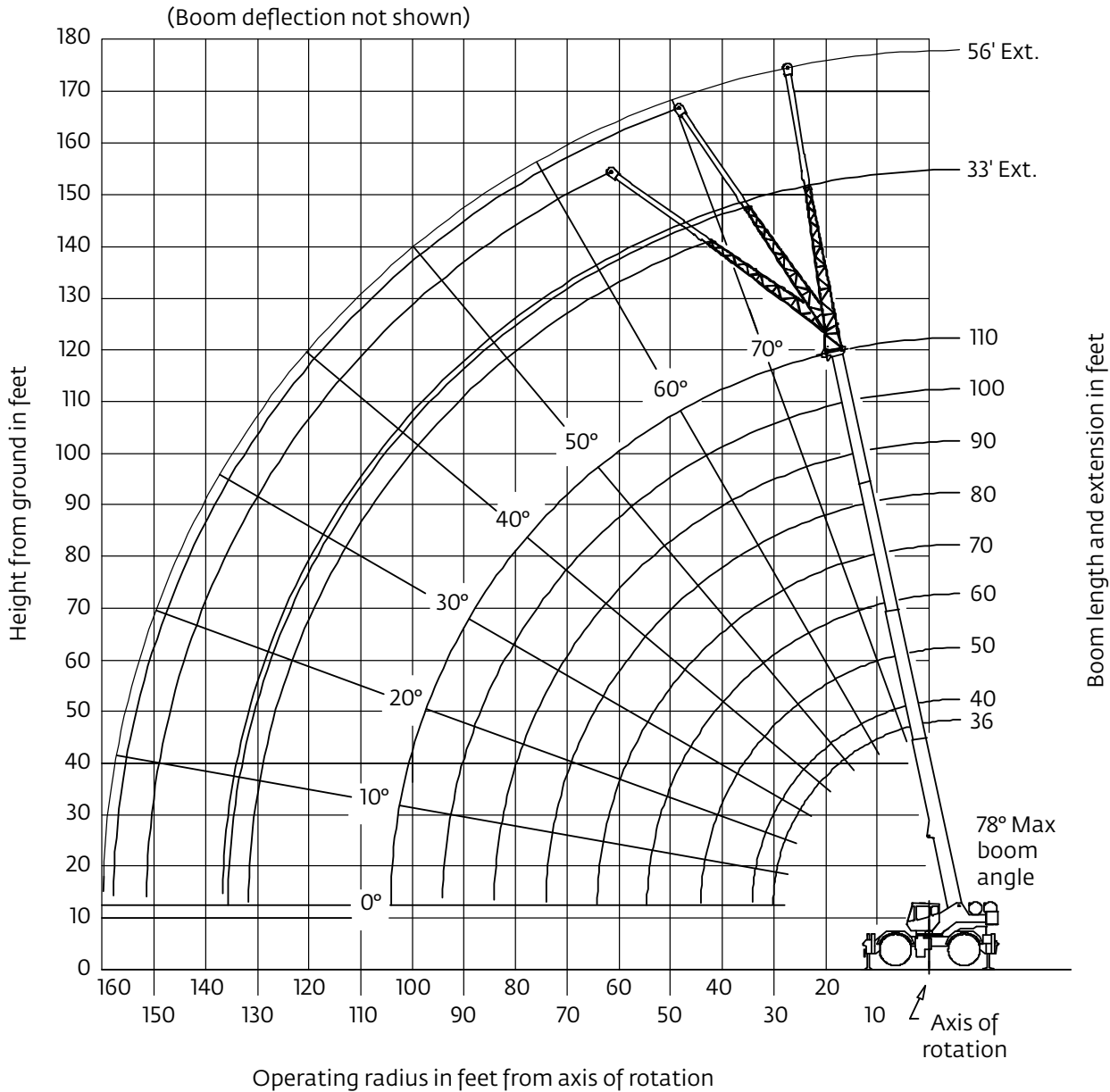

Dimensions are for largest Grove furnished hook block and headache ball, with anti-two block activated.

*THIS CHART IS ONLY A GUIDE AND SHOULD NOT BE USED TO OPERATE THE CRANE.  
The individual crane's load chart, operating instructions and other instructional plates must be read and understood prior to operating the crane.*



# Working range

110 ft main boom with one insert and 33 ft - 56 ft bi-fold swingaway

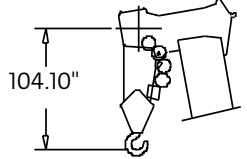
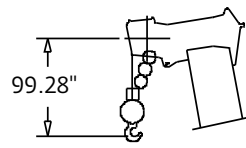
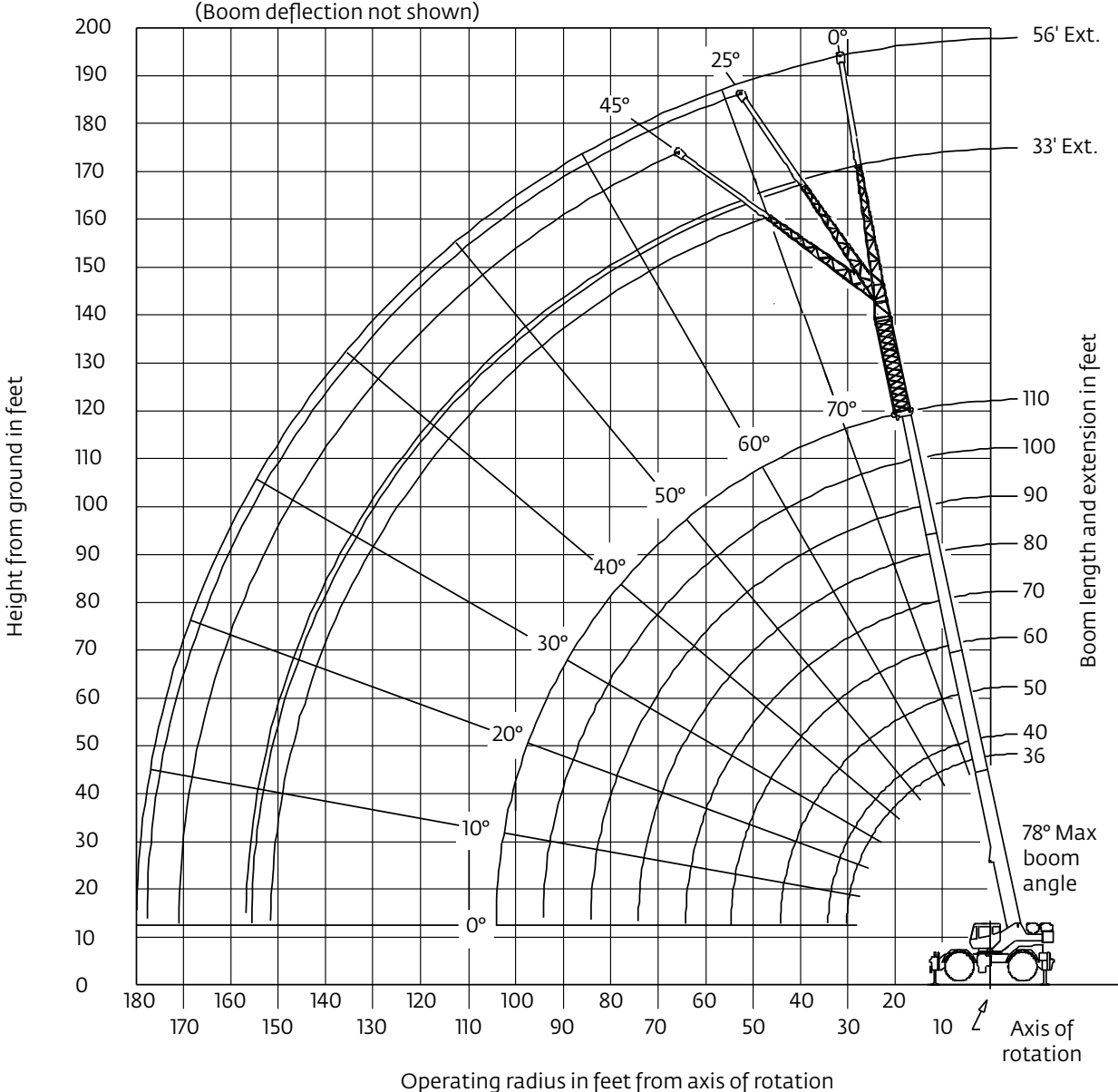

Dimensions are for largest Grove furnished hook block and headache ball, with anti-two block activated.

*THIS CHART IS ONLY A GUIDE AND SHOULD NOT BE USED TO OPERATE THE CRANE. The individual crane's load chart, operating instructions and other instructional plates must be read and understood prior to operating the crane.*

# Working range

110 ft main boom with two inserts and 33 ft - 56 ft bi-fold swingaway

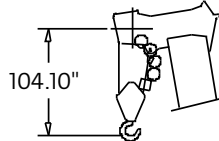
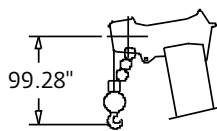
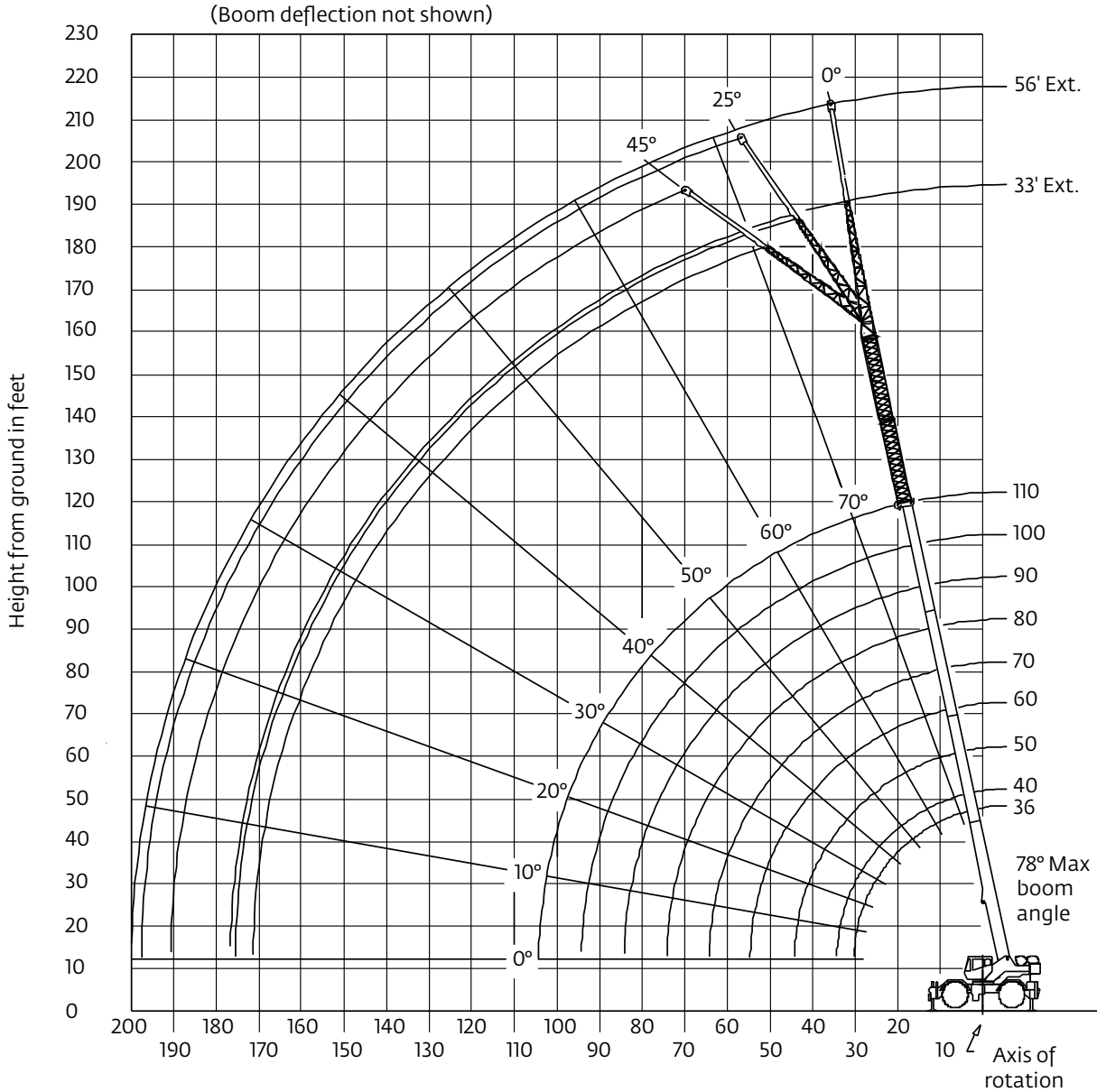

Dimensions are for largest Grove furnished hook block and headache ball, with anti-two block activated.

*THIS CHART IS ONLY A GUIDE AND SHOULD NOT BE USED TO OPERATE THE CRANE. The individual crane's load chart, operating instructions and other instructional plates must be read and understood prior to operating the crane.*



# Load chart



  
 36 ft - 110 ft      14,365 lb      23 ft 4 in (100%)      360°

Radius in feet	#0001								
	Main boom length in feet								
	36	40	50	**60	70	80	90	100	110
10	130,000 (69.5)	90,300 (71.5)	90,300 (75.5)	*62,500 (78)					
12	112,500 (65.5)	90,300 (68.5)	90,300 (73)	62,500 (76.5)	*40,200 (78)				
15	93,250 (60)	90,300 (63.5)	90,250 (69.5)	62,500 (73.5)	40,200 (76)	*40,200 (78)			
20	71,550 (49.5)	71,500 (55)	71,300 (63)	62,500 (68)	40,200 (71.5)	40,200 (74.5)	40,200 (78)	*36,900 (78)	
25	56,650 (36.5)	56,600 (45)	56,350 (56)	53,650 (63)	40,200 (67)	40,200 (70.5)	37,950 (73)	34,900 (75)	*25,150 (78)
30	43,500 (11.5)	44,300 (32)	43,950 (48.5)	43,650 (57.5)	40,200 (62.5)	36,050 (66.5)	32,750 (69.5)	30,200 (72)	25,150 (74)
35			33,550 (40)	33,700 (51.5)	34,700 (58)	31,450 (62.5)	28,550 (66)	26,400 (69)	24,700 (71.5)
40			25,800 (28)	26,150 (44.5)	26,900 (52.5)	27,700 (58.5)	25,200 (62.5)	23,300 (66)	21,800 (68.5)
45				20,650 (36.5)	21,450 (47)	22,300 (54)	22,400 (59)	20,700 (62.5)	19,400 (65.5)
50				16,550 (26.5)	17,400 (41)	18,250 (49.5)	19,100 (55)	18,550 (59.5)	17,350 (62.5)
55					14,300 (33.5)	15,150 (44)	16,000 (51)	16,400 (56)	15,600 (60)
60					11,800 (23.5)	12,700 (38.5)	13,550 (46.5)	13,950 (52.5)	14,100 (56.5)
65						10,700 (31.5)	11,550 (41.5)	11,950 (48.5)	12,300 (53.5)
70						9010 (22.5)	9920 (36)	10,250 (44)	10,650 (50)
75							8510 (29.5)	8890 (39.5)	9250 (46)
80							7260 (21)	7690 (34.5)	8050 (42.5)
85								6620 (28.5)	7010 (38)
90								5630 (20)	6100 (33)
95									5240 (27)
100									4480 (19.5)
Minimum boom angle (°) for indicated length (no load)									0
Maximum boom length (ft) at 0° boom angle (no load)									110





NOTE: ( ) Boom angles are in degrees.  
 #LMI operating code. Refer to LMI manual for operating instructions.  
 \*This capacity is based on maximum boom angle.

Lifting capacities at zero degree boom angle									
Boom angle	Main boom length in feet								
	36	40	50	**60	70	80	90	100	110
0°	30,350 (30.1)	25,700 (34.2)	17,950 (44.2)	13,050 (54.6)	10,050 (64.2)	7790 (74.2)	6300 (84.2)	4900 (94.2)	3900 (104.2)



NOTE: ( ) Reference radii in feet. 80039604  
 \*\* Boom length is with inner-mid fully extended and outer-mid & fly fully retracted.

THIS CHART IS ONLY A GUIDE AND SHOULD NOT BE USED TO OPERATE THE CRANE.  
 The individual crane's load chart, operating instructions and other instructional plates must be read and understood prior to operating the crane.

# Load chart

**36 ft - 110 ft**   **33 ft - 56 ft**   **14,365 lb**   **23 ft 4 in (100%)**   **360°**



 Pounds

Feet	33 ft LENGTH			56 ft LENGTH		
	0° OFFSET	25° OFFSET	45° OFFSET	0° OFFSET	25° OFFSET	45° OFFSET
30	12,900 (78)					
35	12,900 (76.5)			*8330 (78)		
40	12,900 (74.5)	*10,850 (78)		8330 (77.5)		
45	12,900 (72)	10,450 (76.5)	*7410 (78)	8330 (76)		
50	12,100 (70)	10,000 (74.5)	7200 (77.5)	8330 (74)		
55	11,100 (68)	9220 (72.5)	6990 (75.5)	8250 (72)	*5300 (78)	
60	10,100 (65.5)	8550 (70)	6800 (73)	7540 (70.5)	5140 (77.5)	
65	9130 (63.5)	7930 (67.5)	6650 (70.5)	7160 (68.5)	5100 (75.5)	*3860 (78)
70	8460 (61)	7380 (65.5)	6490 (68)	6820 (66.5)	5100 (73.5)	3790 (77.5)
75	7840 (58.5)	6900 (63)	6370 (65.5)	6300 (64.5)	4800 (71.5)	3660 (75.5)
80	7230 (56)	6470 (60.5)	6110 (63)	5810 (62.5)	4580 (69.5)	3550 (73)
85	6690 (53.5)	6070 (58)	5780 (60)	5370 (60.5)	4470 (67)	3,450 (71)
90	6140 (51)	5720 (55.5)	5480 (57.5)	4980 (58.5)	4330 (65)	3410 (68.5)
95	5670 (48.5)	5400 (52.5)	5200 (54.5)	4,630 (56.5)	4070 (63)	3,300 (66.5)
100	5150 (45.5)	5100 (49.5)	4950 (51.5)	4320 (54)	3830 (60.5)	3260 (64)
105	4650 (42.5)	4760 (46.5)	4650 (48)	4040 (52)	3620 (58.5)	3220 (61.5)
110	4,070 (39.5)	4430 (43)		3770 (49.5)	3410 (56)	3180 (59)
115	3540 (36)	3930 (39.5)		3540 (47.5)	3230 (53.5)	3060 (56)
120	3060 (32)	3400 (35)		3310 (45)	3050 (50.5)	2940 (53)
125	2630 (27)	2920 (30)		3070 (42)	2890 (48)	2800 (50)
130	2230 (21.5)			2770 (39.5)	2730 (45)	
135				2400 (36.5)	2590 (41.5)	
140				2050 (33)	2410 (38)	
145				1720 (29)	2040 (33.5)	
150				1420 (24.5)		
Minimum boom angle (°) for indicated length (no load)	19	29	47	23	32	49
Maximum boom length (ft) at 0° boom angle (no load)	100			90		

NOTE: ( ) Boom angles are in degrees. 80039607  
 \*This capacity is based upon maximum boom angle.







## NOTES:

- All capacities above the bold line are based on structural strength of boom extension.
- 33 ft and 56 ft boom extension lengths may be used for single line lifting service.
- For main boom lengths less than 110 ft with the boom extension erected, the rated loads are determined by boom angle. Use only the column which corresponds to the boom extension length and offset for which the machine is set up. For boom angles not shown, use the rating of the next lower boom angle.
- WARNING:** Operation of this machine with heavier loads than the capacities listed is strictly prohibited. Machine tipping with boom extension occurs rapidly and without advance warning.
- Boom angle is the angle above or below horizontal of the longitudinal axis of the boom base section after lifting rated load.
- Capacities listed are with outriggers fully extended and vertical jacks set only.
- When lifting over the main boom nose with 33 ft or 56 ft extension erected, the outriggers must be fully extended or 50% extended (17 ft spread).

*THIS CHART IS ONLY A GUIDE AND SHOULD NOT BE USED TO OPERATE THE CRANE.*

*The individual crane's load chart, operating instructions and other instructional plates must be read and understood prior to operating the crane.*

# Load chart

36 ft - 110 ft    56 ft    20 ft    14,365 lb    23 ft 4 in (100%)    360°



 Pounds

Feet	56 ft LENGTH		
	0° OFFSET	25° OFFSET	45° OFFSET
40	*6300 (78)		
45	6300 (77.5)		
50	6000 (76.5)		
55	5990 (75)		
60	5980 (73)	*4840 (78)	
65	5510 (71.5)	4840 (77.5)	
70	5010 (70)	4440 (76)	
75	4560 (68)	4050 (74.5)	*3760 (78)
80	4170 (66.5)	3870 (72.5)	3460 (76.5)
85	3820 (64.5)	3570 (71)	3260 (74.5)
90	3520 (63)	3320 (69)	2960 (72.5)
95	3220 (61)	3070 (67)	2770 (70.5)
100	2980 (59)	2880 (65.5)	2570 (68.5)
105	2780 (57.5)	2680 (63.5)	2460 (66.5)
110	2530 (55.5)	2480 (61.5)	2340 (64.5)
115	2340 (53.5)	2280 (59.5)	2200 (62)
120	2190 (51.5)	2140 (57.5)	2050 (60)
125	2000 (49.5)	1990 (55)	1910 (57.5)
130	1850 (47.5)	1850 (53)	1810 (55)
135	1720 (45)	1750 (50.5)	1670 (52.5)
140	1610 (43)	1610 (48)	
145		1520 (45)	
150		1370 (42.5)	
Minimum boom angle (°) for indicated length (no load)	42	41	50
Maximum boom length (ft) at 0° boom angle (no load)	70		

80039609A

NOTE: ( ) Boom angles are in degrees.

*THIS CHART IS ONLY A GUIDE AND SHOULD NOT BE USED TO OPERATE THE CRANE.*

*The individual crane's load chart, operating instructions and other instructional plates must be read and understood prior to operating the crane.*

## NOTES:

1. All capacities above the bold line are based on structural strength of boom extension.

2. The 56 ft boom extension length may be used for single line lifting service only.

3. For main boom lengths less than 110 ft with the boom extension erected, the rated loads are determined by boom angle. Use only the column which corresponds to the boom extension length and offset for which the machine is set up. For boom angles not shown, use rating of the next lower boom angle.

4. **WARNING:** Operation of this machine with heavier loads than the capacities listed is strictly prohibited. Machine tipping with boom extension occurs rapidly and without advance warning.

5. Boom angle is the angle above or below horizontal of the longitudinal axis of the boom base section after lifting rated load.

6. Capacities listed are with outriggers fully extended and vertical jacks set only.

7. When lifting over the main boom nose with 56 ft extension erected and 20 ft insert, the outriggers must be fully extended or 50% extended (17 ft spread).

# Load chart

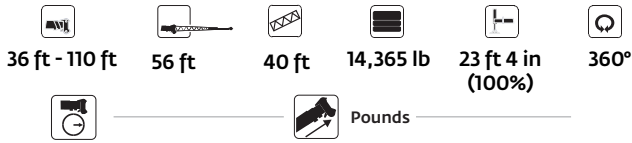

Feet	56 ft LENGTH		
	0° OFFSET	25° OFFSET	45° OFFSET
50	4510 (78)		
55	4210 (77)		
60	3910 (75.5)		
65	3710 (74)		
70	3410 (72.5)	*3710 (78)	
75	3220 (71)	3420 (76.5)	
80	2820 (69.5)	3120 (75)	
85	2520 (68)	2820 (73.5)	2730 (77.5)
90	2320 (66.5)	2620 (72)	2530 (75.5)
95	2030 (65)	2330 (70.5)	2340 (74)
100	1830 (63)	2130 (68.5)	2140 (72)
105	1630 (61.5)	1930 (67)	1940 (70.5)
110	1440 (60)	1730 (65.5)	1740 (68.5)
115	1240 (58.5)	1540 (63.5)	1550 (66.5)
120	1140 (56.5)	1340 (62)	1450 (64.5)
125		1240 (60)	1260 (62.5)
130		1050 (58)	1160 (60.5)
No Load Stability Data			
Min. boom angle (°) for indicated length	55	57	59
Max. boom length (ft) at 0° boom angle	40		

80039614A

NOTE: ( ) Boom angles are in degrees.  
\*This capacity is based upon maximum boom angle.

## NOTES:

- All capacities above the bold line are based on structural strength of boom extension.
- The 56 ft boom extension length may be used for single line lifting service only.
- For main boom lengths less than 110 ft with the boom extension erected, the rated loads are determined by boom angle. Use only the column which corresponds to the boom extension length and offset for which the machine is set up. For boom angles not shown, use rating of the next lower boom angle.
- WARNING:** Operation of this machine with heavier loads than the capacities listed is strictly prohibited. Machine tipping with boom extension occurs rapidly and without advance warning.
- Boom angle is the angle above or below horizontal of the longitudinal axis of the boom base section after lifting rated load.
- Capacities listed are with outriggers fully extended and vertical jacks set only.
- When lifting over the main boom nose with 56 ft extension erected and 40 ft insert, the outriggers must be fully extended or 50% extended (17 ft spread).

THIS CHART IS ONLY A GUIDE AND SHOULD NOT BE USED TO OPERATE THE CRANE.

The individual crane's load chart, operating instructions and other instructional plates must be read and understood prior to operating the crane.

# Load chart





**36 ft - 110 ft**    **14,365 lb**    **Stationary**    **360°**



 Pounds

Feet	Main boom length in feet				
	36	40	50	*60	70
10	45,300 (69.5)	39,700 (71.5)			
12	41,500 (66)	39,700 (68.5)	29,600 (73)		
15	32,450 (60)	31,750 (63.5)	26,450 (69.5)	20,900 (73.5)	
20	19,200 (50)	18,850 (55)	18,750 (63)	18,550 (68)	17,300 (71.5)
25	12,600 (36.5)	12,350 (44.5)	12,250 (56)	12,050 (63)	12,550 (67)
30	8650 (11.5)	8530 (31.5)	8250 (48.5)	8150 (57)	8710 (62.5)
35			5600 (39.5)	5450 (51)	6170 (57.5)
40			3700 (28)	3410 (44)	4300 (52)
45				1760 (36)	2850 (46.5)
50					1250 (40)
Minimum boom angle (°) for indicated length (no load)				35	39
Maximum boom length (ft) at 0° boom angle (no load)				50	

NOTE: ( ) Reference boom angles in degrees.

Lifting capacities at zero degree boom angle					
Boom angle	Main boom length in feet				
	36	40	50		
0°	8580 (30.1)	6310 (34.2)	2270 (44.2)		

Note: ( ) Reference radii in feet

80039611

\*60 ft. boom length is with inner-mid extended and outer-mid & fly retracted.

## NOTES TO ALL RUBBER CAPACITY CHARTS:

- Capacities are in pounds and do not exceed 75% of tipping loads as determined by test in accordance with SAE J765.
- Capacities are applicable to machines equipped with 29.5 x 25 (28 or 34 ply General/Titan, Denman Rock Plus, Denman Broadway and Advance bias plus ply) tires at 65 psi cold inflation pressure.
- Capacities appearing above the bold line are based on structural strength and tipping should not be relied upon as a capacity limitation.
- Capacities are applicable only with machine on firm level surface.
- On rubber lifting with boom extensions not permitted.
- For pick and carry operation, boom must be centered over front of machine, mechanical swing lock engaged and load restrained from swinging.
- Axle lockouts must be functioning when lifting on rubber.
- All lifting depends on proper tire inflation, capacity and condition. Capacities must be reduced for lower tire inflation pressures. See lifting capacity chart for tire used. Damaged tires are hazardous to safe operation of crane.
- Creep - not over 200 ft of movement in any 30 minute period and not exceeding 1 mph.

THIS CHART IS ONLY A GUIDE AND SHOULD NOT BE USED TO OPERATE THE CRANE.

The individual crane's load chart, operating instructions and other instructional plates must be read and understood prior to operating the crane.

# Load charts





  
**36 ft - 110 ft    14,365 lb    Pick and carry up to 2.5 mph    Over front**



Pounds

Feet	Main boom length in feet				
	36	40	50	*60	70
10	47,200 (69.5)	44,000 (71.5)	34,000 (75.5)		
12	47,200 (66)	44,000 (68.5)	34,000 (73)	28,500 (76.5)	
15	43,250 (60)	42,500 (63.5)	34,000 (69.5)	28,500 (73.5)	21,350 (75.5)
20	32,950 (50)	32,600 (55)	32,250 (63)	28,500 (68)	21,350 (71.5)
25	25,450 (36.5)	24,850 (44.5)	25,250 (56)	25,250 (63)	21,350 (67)
30	16,150 (11.5)	16,100 (31.5)	16,200 (48.5)	16,200 (57)	19,000 (62.5)
35			12,850 (39.5)	12,850 (51)	13,750 (57.5)
40			9550 (28)	9970 (44)	10,950 (52)
45				7470 (36)	8470 (46.5)
50				5550 (26)	6540 (40)
55					5010 (33)
60					3760 (23)
Minimum boom angle (°) for indicated length (no load)					0
Maximum boom length (ft) at 0° boom angle (no load)					70

NOTE: ( ) Reference boom angles in degrees.

Lifting capacities at zero degree boom angle					
Boom angle	Main boom length in feet				
	36	40	50	*60	70
0°	16,150 (30.1)	12,950 (34.2)	7390 (44.2)	4140 (54.6)	2880 (64.2)

Note: ( ) Reference radii in feet

\* 60 ft. boom length is with inner-mid extended and outer-mid & fly retracted.

## NOTES TO ALL RUBBER CAPACITY CHARTS:

1. Capacities are in pounds and do not exceed 75% of tipping loads as determined by test in accordance with SAE J765.

2. Capacities are applicable to machines equipped with 29.5 x 25 (28 or 34 ply General/Titan, Denman Rock Plus, Denman Broadway and Advance bias plus ply) tires at 65 psi cold inflation pressure.

3. Capacities appearing above the bold line are based on structural strength and tipping should not be relied upon as a capacity limitation.

4. Capacities are applicable only with machine on firm level surface.

5. On rubber lifting with boom extensions not permitted.

6. For pick and carry operation, boom must be centered over front of machine, mechanical swing lock engaged and load restrained from swinging.

7. Axle lockouts must be functioning when lifting on rubber.

8. All lifting depends on proper tire inflation, capacity and condition. Capacities must be reduced for lower tire inflation pressures. See lifting capacity chart for tire used. Damaged tires are hazardous to safe operation of crane.

9. Creep - not over 200 ft of movement in any 30 minute period and not exceeding 1 mph.

*THIS CHART IS ONLY A GUIDE AND SHOULD NOT BE USED TO OPERATE THE CRANE.*

*The individual crane's load chart, operating instructions and other instructional plates must be read and understood prior to operating the crane.*



# Load handling

Weight reductions for load handling devices		
33 ft - 56 ft: Folding boom extension:		
	Without block or ball	With 355 lb overhaul ball
*33 ft extension (erected)	3850 lb	5980 lb
*56 ft extension (erected)	8620 lb	12,170 lb
Folding extension with 20 ft insert:		
*33 ft extension (erected)	7480 lb	10,370 lb
*56 ft extension (erected)	13,320 lb	17,740 lb
Folding extension with 40 ft insert:		
*33 ft extension (erected)	9990 lb	12,360 lb
*56 ft extension (erected)	14,610 lb	17,730 lb
*Reduction of main boom capacities (no deduct required for stowed boom extension).		
Auxiliary boom nose:		
		130 lb
Hook blocks and headache balls:		
66 USt, 5-sheave		1280 lb +
50 USt, 3-sheave		992 +
40 USt, 3-sheave		1,071 +
29 USt, single sheave		712+
10 USt, overhaul weight		434+
8.3 USt, overhaul ball		355+

+Refer to rating plate for actual weight

When lifting over swingaway and/or jib combinations, deduct total weight of all load handling devices reeved over main boom nose directly from swingaway or jib capacity.

**NOTE:** All load handling devices and boom attachments are considered part of the load and suitable allowances MUST BE MADE for their combined weights. Weights are for Grove furnished equipment.

Line pulls and reeving information			
Hoists	Cable specs	Permissible line pulls	Nominal cable length
Main	3/4" (19 mm) 35x7 Class Rotation Resistant (non-rotating) Min. breaking strength 85,800 lb	16,800 lb*	653 ft
Main	22 mm Synthetic K™-100 Hoist Rope (ISO) Min. breaking strength 84,000 lb	16,800 lb*	673 ft
Main & Auxiliary	3/4" (19 mm) 35x7 Class Rotation Resistant (non-rotating) Min. breaking strength 85,800 lb	16,800 lb*	502 ft
Main & Auxiliary	22 mm Synthetic K™-100 Hoist Rope (ISO) Min. breaking strength 84,000 lb	16,800 lb*	522 ft

The approximate weight of 3/4" wire rope is 1.5 lb/ft.

The approximate weight of 22 mm synthetic rope is 0.21 lb/ft.

\*With certain boom and hoist tackle combinations, the allowable line pull may be limited by hoist performance. Refer to Hoist Performance table for lift planning to ensure adequate hoist performance on drum rope layer required.

Hoist performance				
Wire rope layer	Hoist line pulls two-speed hoist		Drum rope capacity (ft)	
	Low available lb*	High available lb*	Layer	Total
1	18,134	9067	101	101
2	16,668	8334	110	211
3	15,420	7710	120	331
4	14,347	7174	129	460
5	13,413	6707	139	599
6	12,594	6297	149	748

\*Max lifting capacity: 6x37 and 35x7 class = 16,800 lb

Tire inflation - PSI (BAR)		
Size (Front and Rear)	TRA Code	Lifting service, general travel and extended travel
29.5 x 25 (28 or 34) General/Titan, Denman Broadway/Rock Plus	E-3	65 (4.5) See operator's manual for extended roading.)

## Working area diagram

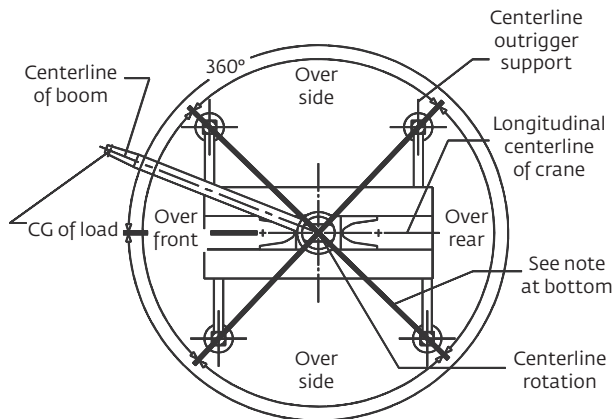

Diagram for lifting on outriggers

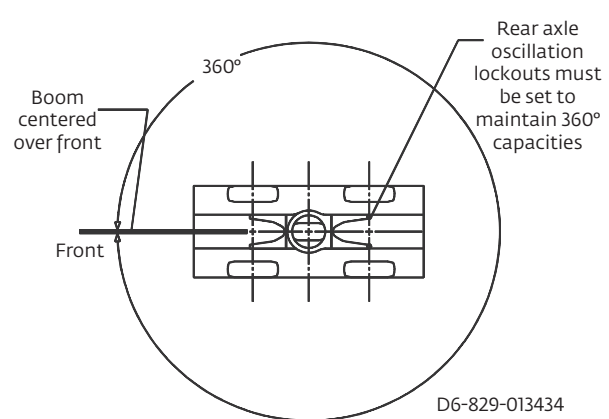

Diagram for lifting on tires

Bold lines determine the limiting position of any load for operation within working areas indicated.

*THIS CHART IS ONLY A GUIDE AND SHOULD NOT BE USED TO OPERATE THE CRANE. The individual crane's load chart, operating instructions and other instructional plates must be read and understood prior to operating the crane.*

# Specifications

## Super Structure

### Boom

11 m - 33,5 m (36 ft - 110 ft) four-section, full-power sequenced synchronized boom.

Maximum tip height: 36,4 m (119 ft).

### \*Optional bi-fold swingaway extension

10,1 m - 17,1 m (33 ft - 56 ft) bi-fold lattice swingaway extension. Offsettable at 0°, 25° and 45°. Stows alongside base boom section. Maximum tip height: 53,2 m (174.5 ft).

### \*Optional 12,2 m (40 ft) inserts

Installs between boom nose and bi-fold extension, non-stowable. Maximum tip height: 59,1 m (194 ft) with 20 ft insert, 65,2 m (214 ft) with 40 ft insert.

### Boom nose

Four nylatron sheaves mounted on heavy-duty tapered roller bearings with removable pin-type rope guards. Quick-reeve type boom nose.

\*Optional removable auxiliary boom nose with removable pin type rope guard.

### Boom elevation

One double-acting hydraulic cylinder with integral holding valve provides elevation from -3° to 78°.

### Load moment and anti-two block system

Standard “Graphic Display” load moment and anti-two block system with audio-visual warning and control lever lockout. These systems provide electronic display of boom angle, length, radius, tip height, relative load moment, maximum permissible load, load indication and warning of impending two-block condition. The standard Work Area Definition System allows the operator to pre-select and define safe working areas. If the crane approaches the pre-set limits, audio-visual warnings aid the operator in avoiding job-site obstructions.

### Cab

Full-vision, all-steel fabricated with acoustical lining and tinted safety glass throughout. Deluxe seat incorporates armrest-mounted hydraulic single-axis controllers. Tilt/telescoping steering wheel with various controls incorporated into the steering column. Other standard features include: hot water heater, cab circulating air fan, sliding side and rear windows, sliding skylight with electric wiper and sunscreen, electric windshield wash/wipe, fire extinguisher, seat belt, air conditioning, and dual cab mounted work light.

### Swing

Planetary swing with foot-applied multi-disc brake. Spring applied, hydraulically-released swing brake and plunger-type, one position, mechanical house lock operated from cab. \*Optional 360° mechanical swing lock. Maximum speed: 2.5 rpm.

### Counterweight

6516 kg (14,365 lb) pinned to superstructure.

### Hydraulic system

Three main gear pumps with a combined capacity of 465 LPM (123 GPM).

Maximum operating pressure: 27,6 MPa (4000 psi). Two individual post pressure compensated valve banks.

Return line type filter with full flow by-pass protection and service indicator. Replaceable cartridge with micron filtration rating of 5/12/16. 507 L (134 gallon) reservoir. Integral oil cooler. System pressure test ports.

### Main and optional auxiliary hoist

Planetary reduction with automatic spring applied multi-disc brake. Grooved drum. Electronic hoist drum rotation indicator and hoist drum cable followers.

Hoist maximum single line pull: 8225 kg (18,134 lb)

Maximum single line speed: 153 m/min (502 fpm)

Maximum permissible line pull:

7620 kg (16,800 lb) with 35 x 7 class rope

Rope diameter: 19 mm (3/4 in)

Rope length: 152 m (500 ft)

Rope type: 35x7 class rotation resistant

Maximum usable rope stowage: 210 m (692 ft).

## Carrier

### Chassis

Box section frame fabricated from high-strength, low alloy steel. Integral outrigger housings and front/rear towing, lifting, and tie down lugs.

### Outrigger system

Four hydraulic telescoping single-stage double box beam outriggers with inverted jacks and integral holding valves. Three position settings, 100%, 50% and fully retracted. All steel fabricated, quick-release type round outrigger floats, 610 mm (24 in) diameter. Maximum outrigger pad load: 41 731 kg (92,000 lb). Outrigger position monitoring system (required for North American, Canada, and E.U. Countries).

*\*Denotes optional equipment*



## Outrigger controls

Controls and crane level indicator located in cab.



## Engine (Tier 4F)

Cummins QSB6.7L diesel six cylinder, turbo-charged with Cummins Compact Catalyst (CCC) & Selective Catalytic Reduction (SCR) combo muffler, using Diesel Exhaust Fluid (DEF) injection. Meets emission per U.S. tier 4F and E.U. stage IV. 194kW (260 bhp) at 2500 r.p.m. Maximum torque: 987 N-m (729 lb-ft) at 1500 r.p.m.

Fuel requirement: Maximum of 15 ppm sulphur content (Ultra Low Diesel Fuel and Diesel Exhaust Fluid (DEF)).

**Note:** Tier 4F engine Required in North American, Canada, and European Union countries.



## Engine (Tier 3)

Cummins QSB 6.7 L diesel, six cylinders, turbocharged, 179 kW (240 bhp) (Gross) at 2500 rpm. Maximum torque: 987 N-m (728 ft lb) at 1500 rpm.

**Note:** Required for sale outside of North American and European Union countries



## Fuel tank capacity

280 L (74 gal) - draw volume



## Transmission

Rangeshift with 6 forward and 6 reverse speeds (3 speeds high and 3 speeds low). Front axle disconnect for 4 x 2 travel.



## Electrical system

Three 12-volt maintenance free batteries. 12-volt starting and lighting, circuit breakers, battery disconnect switch.



## Drive

4 x 4



## Steering

Fully independent power steering:

Front: Full hydraulic, steering wheel controlled.

Rear: Full hydraulic, switch controlled.

Provides infinite variations of 4 main steering modes: front only, rear only, crab and coordinated.

Rear steer centered indicating light.

4 wheel outside turning radius - 7,1 m (23 ft 4 in).



## Axles

Front: Drive/steer with differential and planetary reduction hubs rigid-mounted to frame.

Rear: Drive/steer with differential and planetary reduction hubs pivot-mounted to frame.

Automatic full hydraulic lockouts on rear axle permit 203 mm (8 in) oscillation only with boom centered over the front.



## Brakes

Full hydraulic split circuit brakes operating on all wheels. Spring-applied, hydraulically released axle-mounted parking brake.



## Tires

29.5 x 25 - 28PR bias earthmover type.



## Lights

Full lighting package including turn indicators, head, tail, brake and hazard warning lights.



## Maximum speed

37 km/h (23 mph) (no load).



## Gradeability (theoretical)

130% (Based on 42 594 kg [93,902 lb] GVW) 29.5 x 25 tires, pumps engaged, 33,6 m (110 ft) boom, bi-fold extension, aux. hoist and cable, and 66 USt hook block.

## Miscellaneous standard equipment

Full width steel fenders, full length steel decking, dual rear view mirrors, hook block tiedown, electronic back-up alarm, light package, front stowage well, tachometer, rear wheel position indicator, hot water heater, air conditioning package with hydraulic driven air conditioning, hoist mirrors, engine distress A/V warning system. Auxiliary hoist control valve arrangement (less hoist). Cold start aid and immersion type engine block heater, 120V 750 watt. Hoist access platform.

## \*Optional equipment

- Auxiliary Hoist Package includes auxiliary hoist with electronic hoist drum rotation indicator, hoist drum cable follower, 152 m (500 ft) of 19 mm (3/4 in) 35 X 7 class wire rope, auxiliary single sheave boom nose.
- Auxiliary Light and Convenience Package: includes superstructure mounted amber flashing light, in-cab LMI light bar, and dual base boom mounted floodlights, rubber mat for stowage trough
- "CE" Mark Conformance (sound abatement foam kits, 3rd wrap indicator, emergency auxiliary steering, dual axis joystick controllers)
- Cross axle differential locks (front and rear)
- Manual pump disconnect
- Pintle hook - rear
- 360° positive swinglock
- Hydraulic removable counterweight
- 3rd wrap indicator with function lockout for main hoist or main and auxiliary hoist
- Wireless windspeed indicator
- -29° C (-20° F) Cold weather package
- -40°C (-40° F) Arctic Weather package
- Vertical LMI light tower (externally mounted)
- Synthetic rope for main and/or auxiliary hoist
- Spare tire/wheel
- CraneSTAR asset management system

*\*Denotes optional equipment*

# Symbols glossary



**Axles**



**Drive**



**Heavy duty jib**



**Radius**



**Boom**



**Electrical system**



**Hoist**



**Rotation**



**Boom elevation**



**Engine**



**Hookblock**



**Speed**



**Boom extension**



**Extension**



**Hydraulic system**



**Steering**



**Boom length**



**Frame**



**Insert**



**Suspension**



**Boom nose**



**Fuel tank capacity**



**Lights**



**Swing**



**Brakes**



**Gear**



**Oil**



**Tires**



**Cab**



**Grade**



**Outrigger controls**



**Transmission**



**Counterweight**



**Height (no max)**



**Outriggers**



## Manitowoc Cranes

### Regional headquarters

#### Americas

Milwaukee, Wisconsin, USA  
Tel: +1 414 760 4600

Shady Grove, Pennsylvania, USA  
Tel: +1 717 597 8121

#### Europe and Africa

Dardilly, France - TOWERS  
Tel: +33 (0) 4 72 18 20 20

Wilhelmshaven, Germany - MOBILE  
Tel: +49 (0) 4421 294 0

#### APAC

Shanghai, China  
Tel: +86 21 6457 0066

Singapore  
Tel: +65 6264 1188

#### Middle East and India

Dubai, UAE  
Tel: +971 4 8862677



This document is non-contractual. Constant improvement and engineering progress make it necessary that we reserve the right to make specification, equipment, and price changes without notice. Illustrations shown may include optional equipment and accessories and may not include all standard equipment.