

The safe choice!

LRT 1100-2.1

Rough Terrain Crane
Grue Rough-Terrain

LIEBHERR

Mobile and Crawler Cranes



110 USt



164 ft



177 ft



226 ft



Technical Data

Caractéristiques technique

Dimensions	
Encombrement	3
Rough Terrain Crane	
Grue Rough-Terrain	4-5
Comfortable Workplace	
Poste de travail confortable	6
Flexible work equipment	
Équipement de travail flexible	7
Proven Telescoping Technology	
Technologie de télescopage expérimentée	8
Telescope modes	
Modes télescopiques	9
Pinning positions	
Positions de boulonnage	9
VarioBase®	10
Transportation	
Transport	11
Weights	
Poids	12
Working speeds	
Vitesses	12
Boom/jib combinations	
Configurations de flèche	13
T	14-18
TK	19-23
Equipment	
Équipement	24-25
Description of symbols	
Explication des symboles	26
Remarks	
Remarques	27

Dimensions

Encombrement

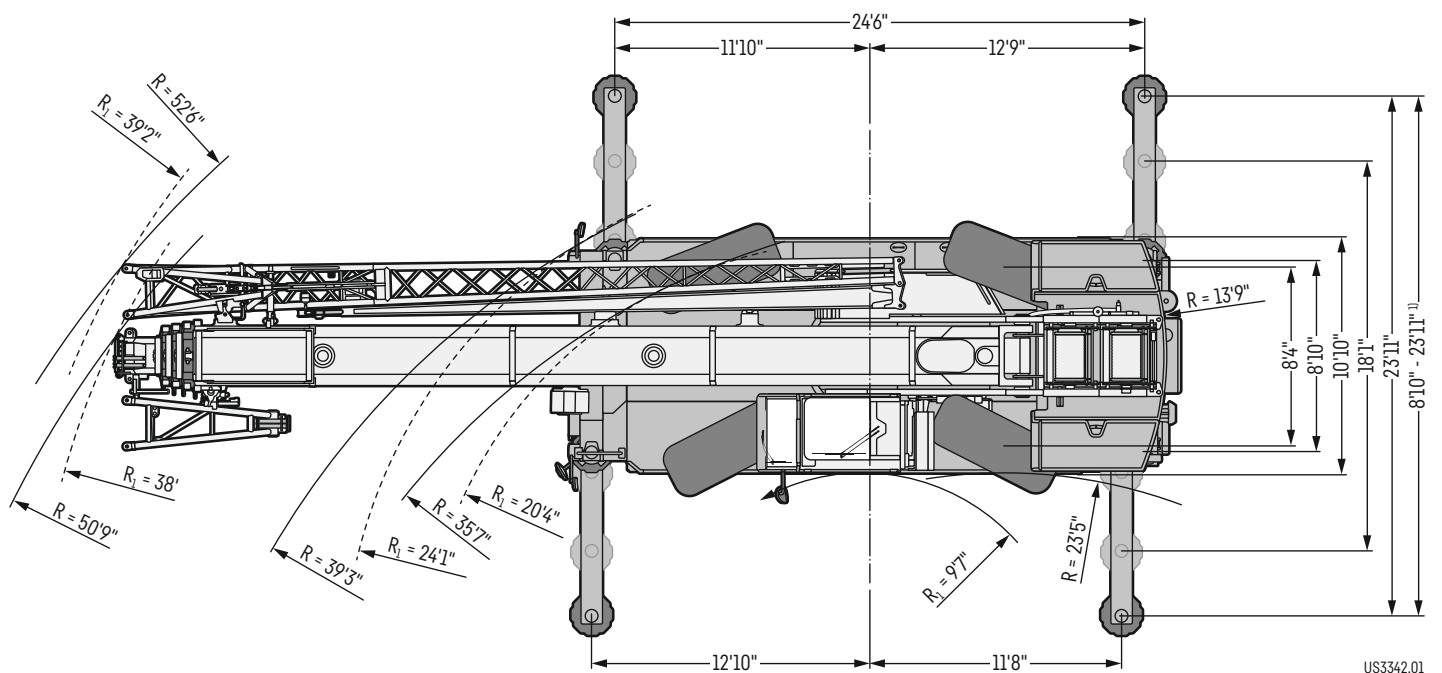
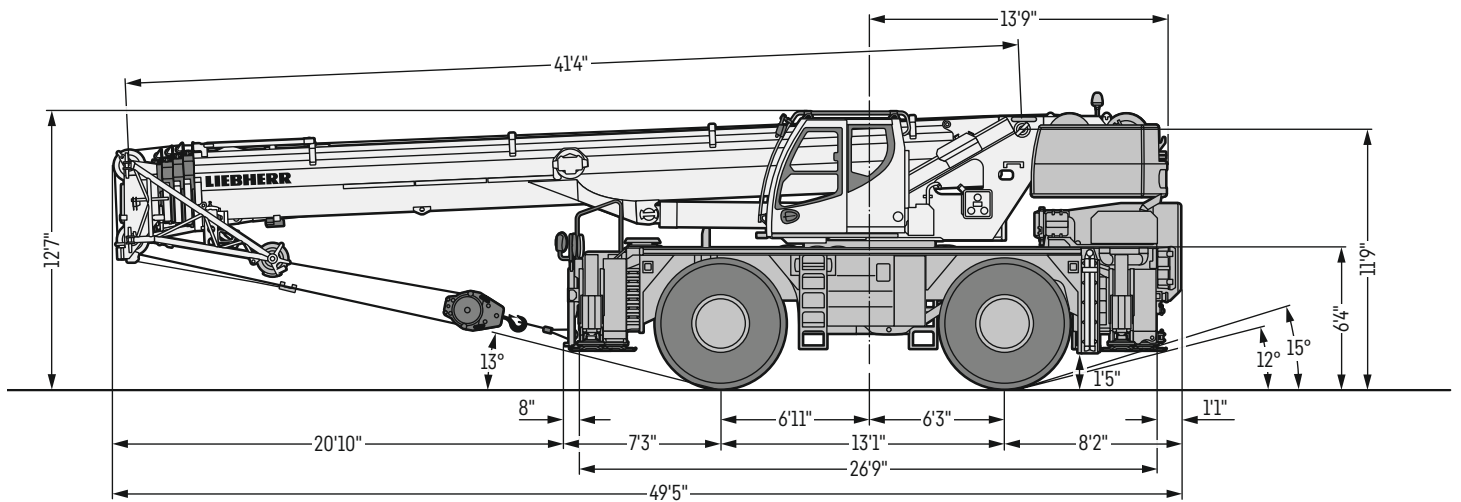

US3342.01

R₁ = All-wheel steering · Direction toutes roues

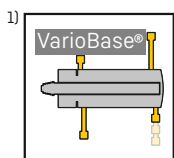

LRT 1100-2.1





Safe and easy operation
Sécurité et simplicité d'utilisation

Automatic support leveling
Mise à niveau automatique du calage

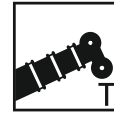

164 ft

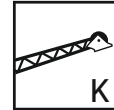

34 ft – 62 ft



6.5 ft

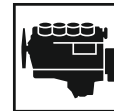

Cummins
194 kW (264 h.p.)

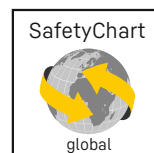
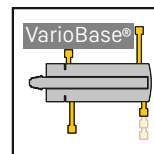

Comfortable workplace

Poste de travail confortable



Extra wide crane cab

- For more comfort 0.7 ft wider than customary cabs
- Simple and safe handling due to clearly layed out and self-explanatory controls
- 20° tiltable backwards
- Sidewards extendable running board for safe access of the crane cab

Cabine de grue extra large

- Plus large de 0.7 ft que les autres cabines disponibles dans le commerce pour plus de confort
- Simplicité et sécurité d'utilisation grâce à des éléments de commande visibles et explicites
- Incluable à 20° vers l'arrière
- Marchepied déployable sur le côté pour un accès sécurisé à la cabine de grue

Flexible work equipment

Équipement de travail flexible

Assembly jib (K 6.5 ft)

- Monitored two-hook operation
- Safe rotation of loads
- Economical transport on the boom

Flechette de montage (K 6.5 ft)

- Mode deux crochets surveillé
- Rotation sécurisé des charges
- Transport économique sur la flèche



Proven telescoping technology

Technologie de télescopage expérimentée

High performance boom with single cylinder system

- Automatic fast cycle telescoping system **TELEMATIK**
- High capacities over the complete working range

Une flèche encore plus puissante avec un système à un vérin

- Système de télescopage séquentiel rapide automatique **TELEMATIK**
- Forces de levage élevées sur l'ensemble de la zone de travail

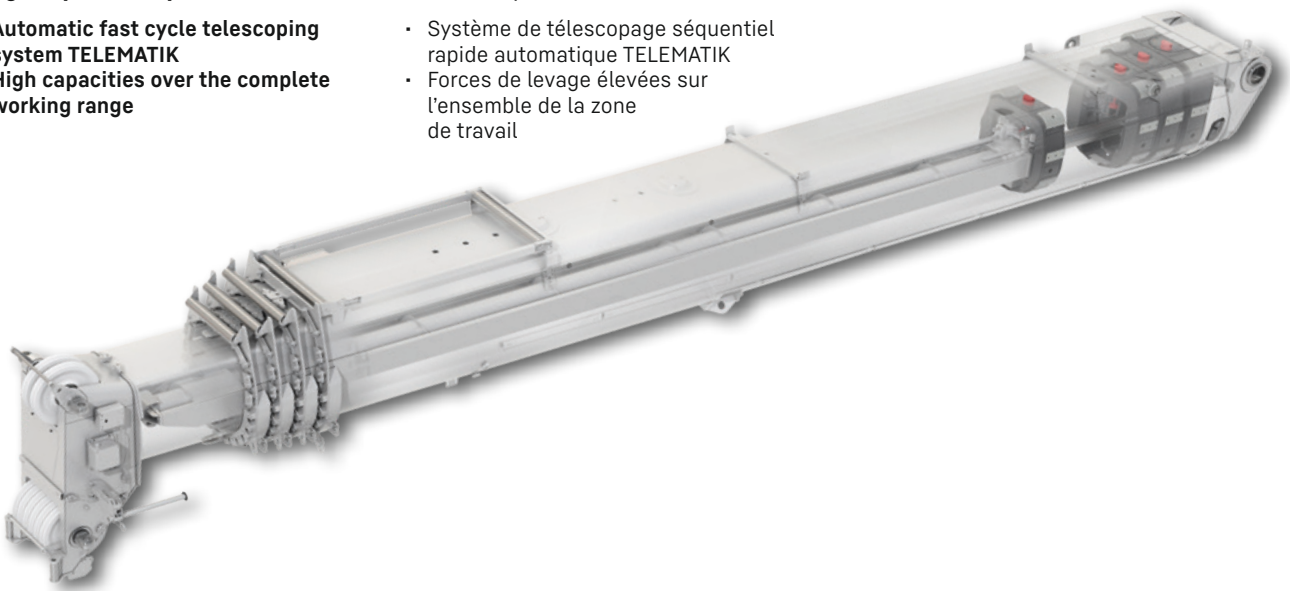

Simple telescoping with two telescope modes

Un télescopage simple avec deux modes télescopiques

Easy selection when the telescopic boom is retracted

Présélection pratique lorsque la flèche télescopique est rentrée



Telescope-Mode "Long"

- + fast telescoping
- + large working radii
- + télescopage rapide
- + grands rayons de travail



Telescope-Mode "Strong"

- + high lifting capacities
- + charges élevées

VarioBase®

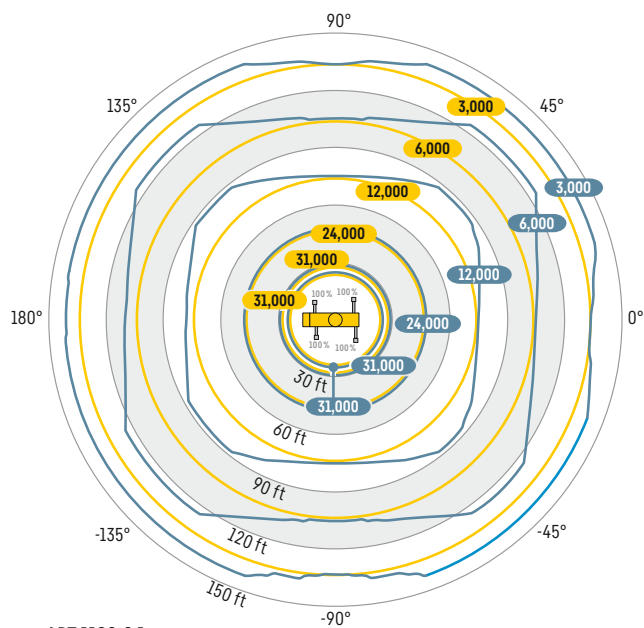

LRT 1100-2.1



Greater safety in constricted working conditions
Plus de sécurité dans les zones de travail étroites

Higher lifting capacity and larger working range
Une capacité plus importante et une zone de travail plus large

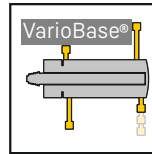

Arbitrary, practical support position Position de calage au choix et pratique

VarioBase® allows each individual crane support to be positioned arbitrarily.

VarioBase® permet de positionner désormais chaque stabilisateur de la grue en fonction des besoins.



Transportation

Transport

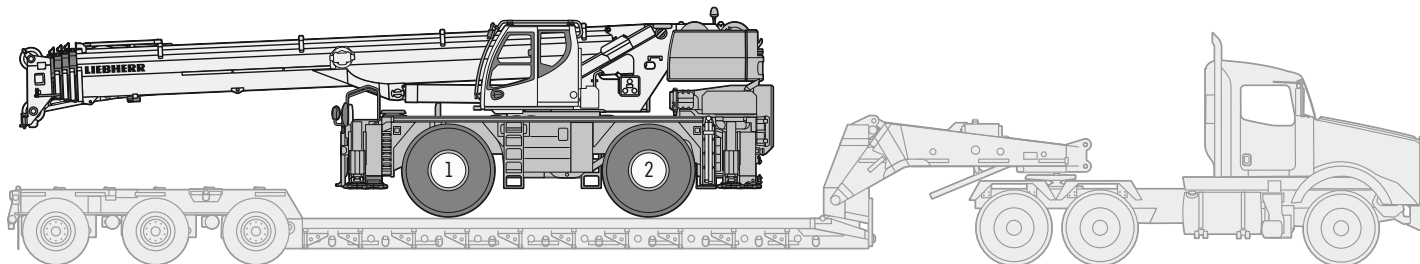



US3251.01

Basic unit - Machine de base

Without ballast,
inclusive auxiliary winch,
boom nose,
boom position at -2.5°

Sans lest,
avec treuil auxiliaire,
poulie en extrémité de mât,
position de la flèche à -2,5°







			
	84,582 lb	57,099 lb	27,483 lb

All weights are to be understood with a difference of ±2.5% - Tous les poids sont indiqués avec une différence de ±2,5%

Crane superstructure - Partie tournante

	+30,867 lb	-9,837 lb	+40,704 lb
Hydraulic ballasting device Dispositif de lestage hydraulique	+915 lb	+1,122 lb	-207 lb

Working attachment - Equipement de travail

		+3,452 lb	+6,210 lb	-2,758 lb
		+512 lb	+1,444 lb	-933 lb
220,000 lb		+1,676 lb	+1,991 lb	-315 lb
142,419 lb		+1,169 lb	+1,387 lb	-218 lb
93,256 lb		+992 lb	+1,177 lb	-185 lb
41,226 lb		+662 lb	+785 lb	-123 lb
13,889 lb		+309 lb	+366 lb	-57 lb

* Transportation position - Position de transport

Weights

Poids



Hook block · Moufles à crochet

220,000 lb		7	14	1,676 lb
142,419 lb		5	11	1,169 lb
93,256 lb		3	7	992 lb
41,226 lb		1	3	661 lb
13,889 lb		-	1	309 lb

Working speeds

Vitesses



Crane carrier · Châssis porteur

29.5 R 25	0 - 1.2	15.5	> 60		3 / R1
					3 / R1

Theoretical gradeability · Aptitude théorique en pente



Crane superstructure · Partie tournante

	0 - 456 ft/min single line · au brin simple	0.67"	787 ft	14,162 lb
	0 - 456 ft/min single line · au brin simple	0.67"	607 ft	14,162 lb
	0 - 1.5 rpm			
	approx. 47 seconds to reach 80.5° boom angle · env. 47 s jusqu'à 80.5°			
	approx. 285 seconds for boom extension from 41 ft - 164 ft · env. 285 s pour passer de 41 ft - 164 ft			

Boom/jib combinations

Configurations de flèche

T Telescopic boom
Flèche télescopique

K Mechanically adjustable folding jib
Pointe pliante réglable mécaniquement

K Assembly jib
Fléchette de montage



S3430

Lifting heights

Hauteurs de levage

T

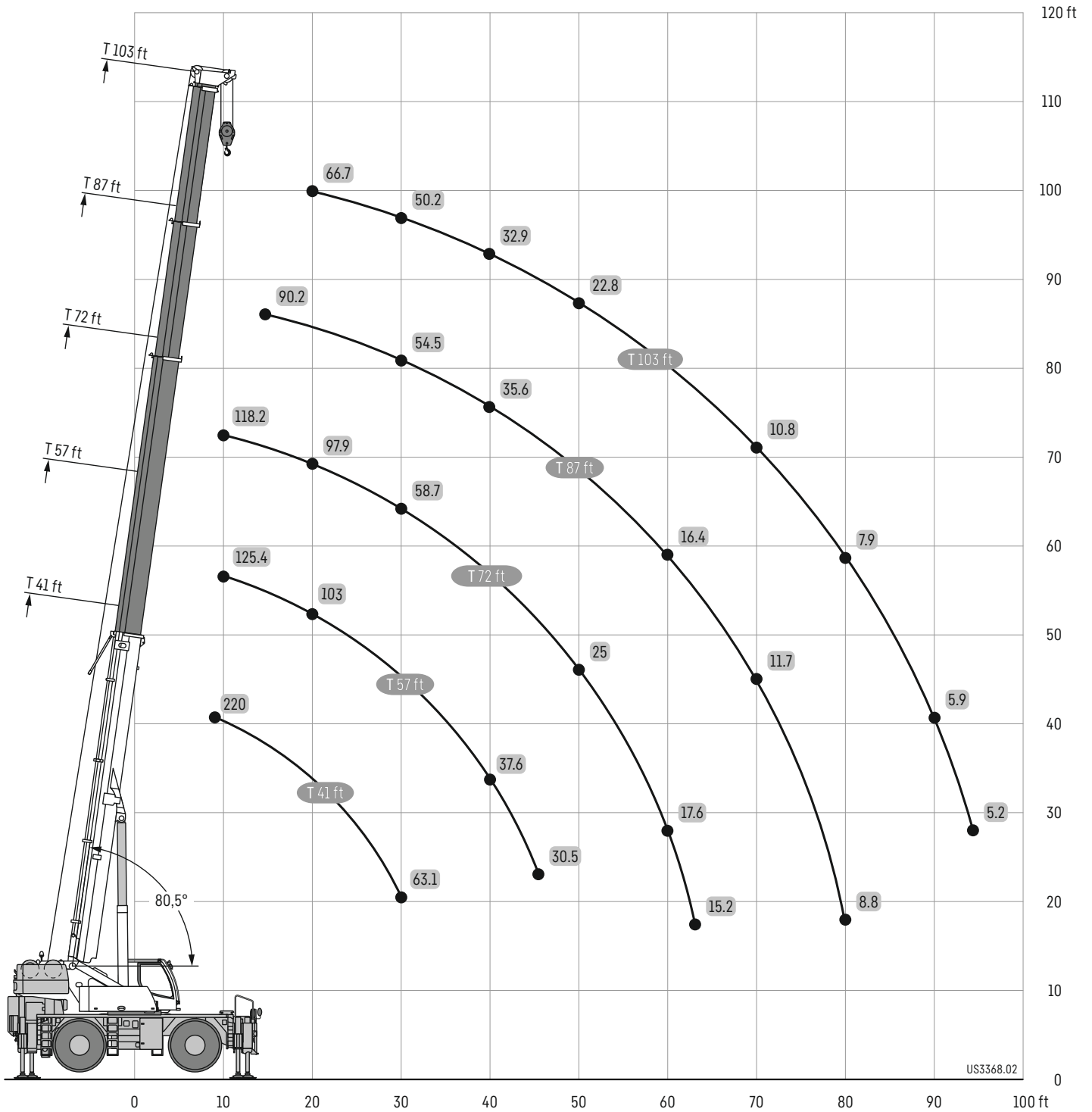
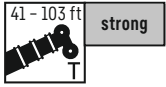

US3368.02

Lifting heights

Hauteurs de levage

T

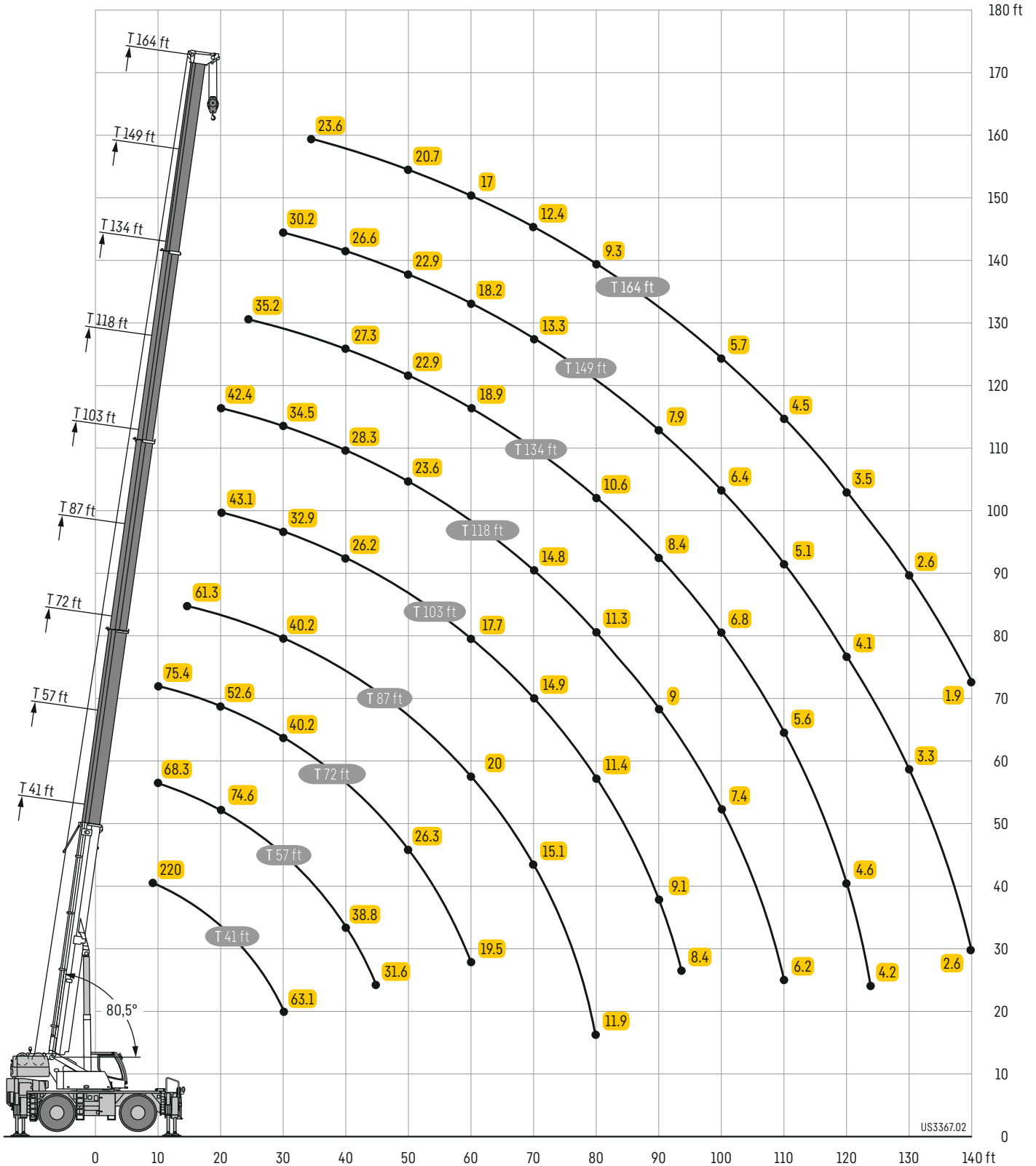
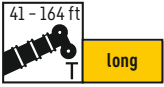

US3367.02

Lifting capacities

Forces de levage

T



	41 ft		57 ft		72 ft		87 ft		103 ft		118 ft	134 ft	149 ft	164 ft	
8	220**	220**													8
10	169.7*	169.7*	125.4	68.3	118.2	75.4									10
15	131	131	123.3	72.2	114.5	62.6	90.2	61.3							15
20	107.8	107.8	103	74.6	97.9	52.6	80.6	52.7	66.7	43.1	42.4				20
25	82.4	82.4	82.8	66.2	77	45.8	67.9	45.3	59.9	37.7	38.1	35.2			25
30	63.1	63.1	62.6	58.3	58.7	40.2	54.5	40.2	50.2	32.9	34.5	32.6	30.2		30
35			47.9	49	46.8	35.9	43.4	35.5	40.2	29.4	31.1	29.9	28.5	23.6	35
40			37.6	38.8	37.4	31.9	35.6	32.2	32.9	26.2	28.3	27.3	26.6	23.1	40
45			30.5	31.6	30.3	29.1	29	29	27.5	23.6	25.9	24.9	24.7	22.2	45
50					25	26.3	23.7	26.2	22.8	21.6	23.6	22.9	22.9	20.7	50
55					20.8	22.7	19.7	23.3	18.8	19.5	21.9	21	20.9	19.1	55
60					17.6	19.5	16.4	20	15.5	17.7	19.7	18.9	18.2	17	60
65					15.2		13.8	17.4	13	16.4	17	16.3	15.5	14.6	65
70							11.7	15.1	10.8	14.9	14.8	14	13.3	12.4	70
75							10	13.3	9.1	13.1	12.9	12.2	11.5	10.7	75
80							8.8	11.9	7.9	11.4	11.3	10.6	10	9.3	80
85									6.8	10.1	10	9.4	8.9	8.2	85
90									5.9	9.1	9	8.4	7.9	7.3	90
95									5.2	8.4	8.1	7.6	7.1	6.4	95
100											7.4	6.8	6.4	5.7	100
105											6.7	6.2	5.7	5.1	105
110											6.2	5.6	5.1	4.5	110
115												5	4.6	4	115
120												4.6	4.1	3.5	120
125												4.2	3.7	3.1	125
130													3.3	2.6	130
135													3	2.3	135
140													2.6	1.9	140

*only with additional pulley block - seulement avec moufle additionnel

**only with additional special equipment - seulement avec équipement supplémentaire

t_273_00011_00_003



	41 ft		57 ft		72 ft		87 ft		103 ft		118 ft	134 ft	149 ft	164 ft	
10	154.1	154.1	125.4	68.3	118.2	75.4									10
15	127.1	127.1	115.1	72.2	98.9	62.6	84.8	61.3							15
20	71.8	71.8	65.7	67.5	59.2	52.6	52.6	52.7	46.8	43.1	42.4				20
25	46.9	46.9	44	45.6	40.6	43.5	36.5	42	32.6	37.7	36.7	33.8			25
30	31.5	31.5	31.7	33	29.7	32.5	26.9	31.9	23.9	30	28.4	26.3	24.3	22.1	30
35			22.7	23.9	22.5	25	20.4	25.1	18	23.8	22.6	20.9	19.4	17.4	35
40			16.7	17.9	16.7	18.9	15.4	19.6	13.8	19.3	18.4	17	15.7	13.9	40
45			12.6	13.6	12.5	14.6	11.3	15.3	10.5	15.4	15	13.9	12.8	11.2	45
50					9.5	11.4	8.6	12.1	7.9	12.1	11.8	10.9	10.3	9.1	50
55					7.6	9.2	6.8	9.8	6	9.7	9.5	8.9	8.2	7.4	55
60					6.1	7.6	5.2	8.2	4.5	8.1	7.9	7.3	6.7	5.9	60
65					5		4.1	6.9	2.9	6.9	6.6	6.1	5.5	4.7	65
70							3	5.9		5.8	5.6	5	4.5	3.7	70
75								5		4.9	4.7	4.2	3.7	2.8	75
80								4.4		4.1	4	3.4	2.9	1.8	80
85										3.5	3.3	2.8	2.1		85
90										2.9	2.8	2.1			90
95										2.4	2.2				95

t_273_00012_00_003

Lifting capacities

Forces de levage

T

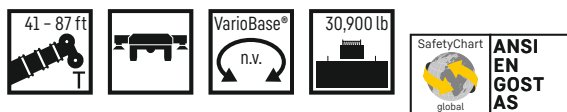

	41 ft	57 ft	72 ft	87 ft	
15	40.3				15
20	30.2	31.7			20
25	23.1	24.7			25
30	18.5	19.4	20.5		30
35		15.9	16.5	17.4	35
40		13.2	13.4	14.1	40
45		11.2	11.2	11.7	45
50			9.5	9.9	50
55			7.7	8.4	55
60			6.6	7.3	60
65				6.2	65
70				5.5	70
75				4.9	75
80				4.2	80

n.v. = over front · en avant

LTR_1100-2.1_Multi_2



	41 ft	57 ft	72 ft	87 ft	
15	28.4				15
20	18.5	17.6			20
25	12.3	12.6			25
30	8.4	9	8.8		30
35		6.6	6.6	6.8	35
40		4.4	4.6	5.1	40
45		2.9	3.1	3.5	45
50			1.8	2.4	50
55			1.1	1.5	55
60				0.9	60

n.v. = over front · en avant

LTR_1100-2.1_Multi_2

Lifting capacities

Forces de levage



	41 ft	57 ft	72 ft	87 ft	
20	19.2				20
25	14.1	15.2			25
30	10.4	11.5	11.7		30
35		8.8	9	9.5	35
40		6.8	7.3	7.7	40
45		5.3	5.7	6.4	45
50			4.4	5.1	50
55			2.4	4.2	55
60			1.8	2.4	60
65				1.5	65
70				1.1	70
75				0.7	75
80				0.4	80

LRT_1100-2.1_Muli_2

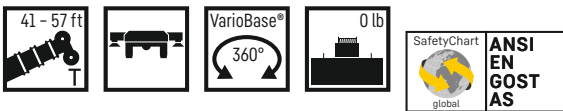

	41 ft	57 ft	
15	7.5		15
20	2.9	3.5	20
25	0.4	1.3	25

LRT_1100-2.1_Muli_2

Lifting heights

Hauteurs de levage

TK

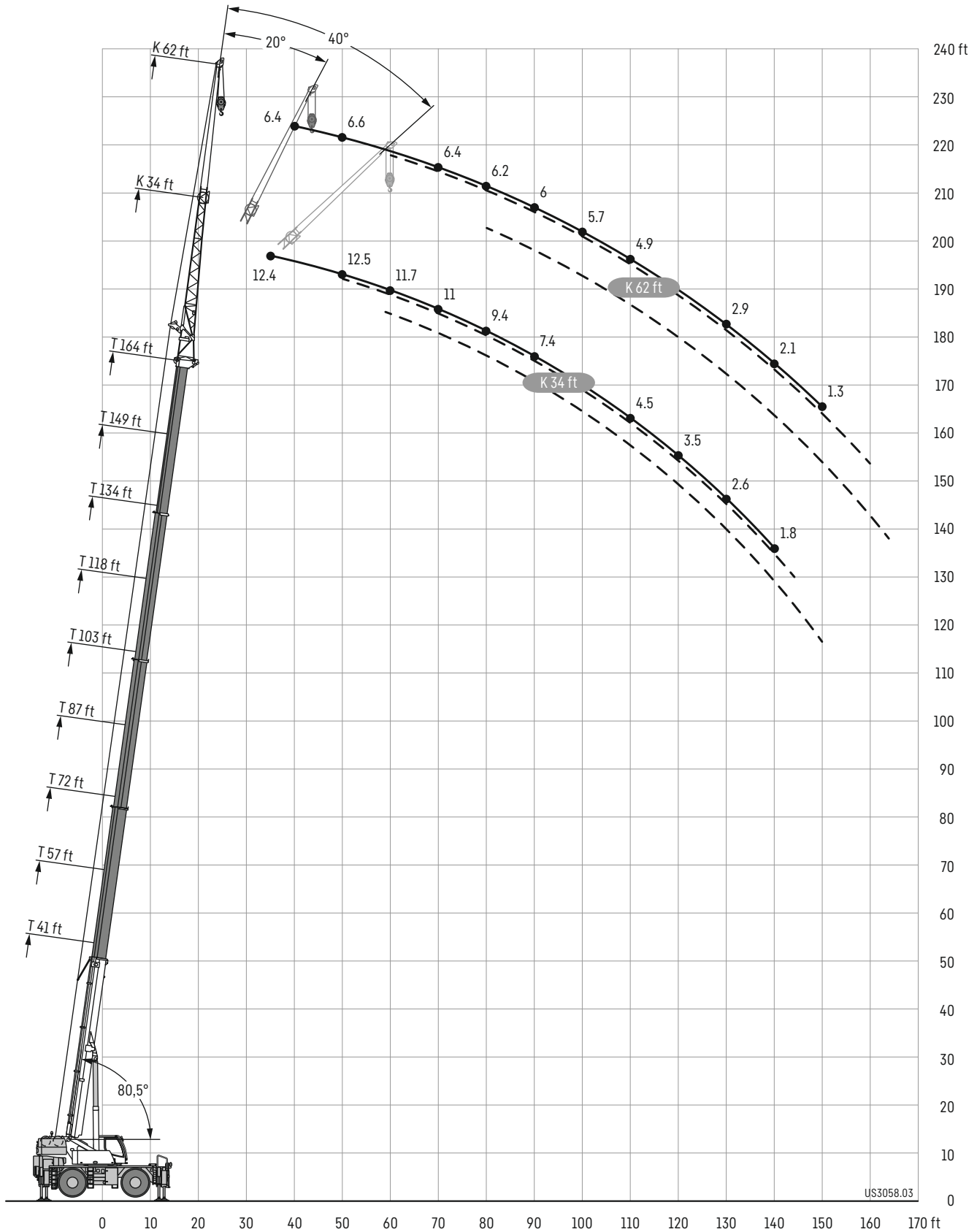

Lifting capacities

Forces de levage

TK

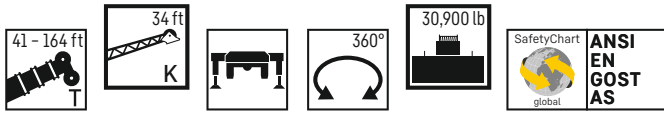

	41 ft			57 ft			72 ft			87 ft			103 ft			118 ft			134 ft			149 ft			164 ft					
	0°	20°	40°	0°	20°	40°	0°	20°	40°	0°	20°	40°	0°	20°	40°	0°	20°	40°	0°	20°	40°	0°	20°	40°	0°	20°	40°			
10	25			25			25			25			25															10		
15	25			25			25			25			25															15		
20	24.5	20.3		25	20.3		25			25			25															20		
25	23	18.6	15	24.6	19.9		25	20.3		25	20.3		25			21.5												25		
30	20.7	17.2	14.5	23.5	18.5	15	24.7	19.6	15	25	20.3	25	20.3		21.4						18.6			16.2				30		
35	18.5	16	13.8	21.7	17.3	14.4	23.7	18.4	14.8	24.8	19.4	15	25	20.1	20.8	18.1					18.4			16.1			12.4	35		
40	16.4	15	13.3	19.7	16.3	13.8	22.4	17.4	14.3	23.9	18.4	14.6	24.8	19.2	14.9	19.3	17.3				18	16.4		16			12.5	40		
45	14.5	13.8	12.9	17.9	15.4	13.4	20.7	16.6	13.8	22.9	17.5	14.2	24.1	18.3	14.5	17.8	16.3	13.9			16.9	15.6		15.8	15		12.6	45		
50	13	12.7	12.3	16.2	14.6	13	19	15.8	13.5	21.4	16.7	13.8	22.9	17.6	14.2	16.4	15.1	13.5	15.8	14.7	13.4	15.1	14.2	15.1	14.2	12.5	12.5	50		
55	11.7	11.8	11.6	14.6	13.6	12.7	17.5	15.1	13.2	19.9	16	13.5	20.1	16.8	13.8	15.3	14.1	13.2	14.8	13.9	12.8	14.3	13.5	12.4	13.5	12.4	12.1	12	55	
60	10.6	11.1	11.1	13.3	12.8	12.2	16.1	14.3	12.9	18.4	15.4	13.2	17.3	16.2	13.6	14.2	13.2	12.5	13.9	13	12.1	13.5	12.8	11.8	11.7	11.5	11.3	60		
65	9.7	10.5	10.9	12.2	12	11.6	14.7	13.5	12.5	16	14.8	13	14.7	15.6	13.3	13	12.3	11.8	13.1	12.3	11.5	12.8	12.1	11.3	11.4	11	10.8	65		
70				11.2	11.3	11.2	13.6	12.8	12.1	13.7	14.1	12.7	12.4	13.6	13.1	12.2	11.6	11.1	12.2	11.6	10.9	12.2	11.5	10.8	11	10.5	10.3	70		
75				10.4	10.8		12.6	12.1	11.6	11.8	12.7	12.4	10.6	11.6	12.3	11.5	10.9	10.5	11.5	10.9	10.4	11.3	10.9	10.3	10.4	10.1	10	75		
80				9.6	10.4		11.3	11.5	11.3	10.3	11	11.5	9.7	10	10.6	10.8	10.3	9.9	10.6	10.4	10	10.1	10.3	9.9	9.4	9.8	9.6	80		
85							10	10.4	10.6	9	9.6	10	9.1	9	9.2	10	9.7	9.5	9.9	9.5	9	9.6	9.5	8.3	9.1	9.2	8.5	85		
90							9.2	9.3		8	8.5	8.8	8.6	8.5	8.5	9.1	9.2	9.1	8.5	9.1	9.2	8	8.6	9.1	7.4	8.1	8.6	90		
95							8.8	8.7		7.2	7.5	7.8	8.1	8	8.1	8.3	8.7	8.7	7.7	8.2	8.6	7.1	7.7	8.3	6.5	7.1	7.7	95		
100										6.4	6.7		7.6	7.6	7.7	7.5	7.9	8.2	6.9	7.4	7.8	6.4	6.9	7.4	5.8	6.4	6.8	100		
105										5.7	6		7.1	7.2	7.3	6.8	7.2	7.4	6.2	6.6	7	5.7	6.2	6.6	5.1	5.6	6.1	105		
110										5.2	5.3		6.5	6.7	6.9	6.2	6.5	6.7	5.6	6	6.3	5.1	5.5	6	4.5	5	5.4	110		
115													5.9	6.1		5.6	5.9	6.1	5.1	5.4	5.7	4.6	5	5.3	4	4.4	4.8	115		
120													5.4	5.6		5.1	5.4	5.5	4.6	4.9	5.1	4.1	4.4	4.8	3.5	3.9	4.2	120		
125													5	5.1		4.7	4.9		4.1	4.4	4.6	3.6	4	4.3	3	3.4	3.7	125		
130																4.3	4.4		3.7	3.9	4.1	3.2	3.5	3.8	2.6	3	3.2	130		
135																3.9	4		3.3	3.5	3.7	2.8	3.1	3.4	2.2	2.6	2.8	135		
140																	3.6	3.7		2.9	3.1		2.5	2.8	2.9	1.8	2.2	2.4	140	
145																		3.3			2.6	2.8		2.1	2.4	2.6		1.8	2	145
150																					2.2	2.4		1.7	2			1.5	150	
155																					1.9	2		1.6					155	
160																						1.6							160	

t_273_00111_00.001

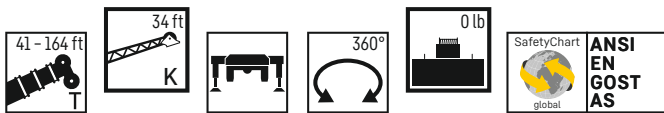

	41 ft			57 ft			72 ft			87 ft			103 ft			118 ft			134 ft			149 ft			164 ft				
	0°	20°	40°	0°	20°	40°	0°	20°	40°	0°	20°	40°	0°	20°	40°	0°	20°	40°	0°	20°	40°	0°	20°	40°	0°	20°	40°		
10	25			25			25			25			25															10	
15	25			25			25			25			25															15	
20	24.5	20.3		25	20.3		25			25			25															20	
25	23	18.6	15	24.6	19.9		25	20.3		25	20.3		25			21.5												25	
30	20.7	17.2	14.5	23.5	18.5	15	24.7	19.6	15	25	20.3	25	20.3		21.4						18.6			16.2				30	
35	18.5	16	13.8	21.7	17.3	14.4	23.6	18.4	14.8	24.8	19.4	15	21.3	20.1	20.7	18.1					18.2			16.1			12.4	35	
40	16.4	15	13.3	19.7	16.3	13.8	20.3	17.4	14.3	21.6	18.4	14.6	18.3	17.4	14.9	17.2	17.3				15.6	16.4		14.3			12.3	40	
45	14.5	13.8	12.9	16.6	15.4	13.4	16.8	16.6	13.8	13.3	15.3	14.2	15.2	16	14.5	14.3	15.9	13.9	12.9	14.6			11.7	13.5			10.4	45	
50	13	12.7	12.3	13.2	14.4	13	13.6	15	13.5	10.8	12.5	13.7	12.8	14.2	13.6	12	13.4	13.5	10.8	12.3	13.4	9.7	11.2			8.5	10.1	50	
55	11.3	11.8	11.6	10.6	11.7	12.6	11	12.1	13.1	8.7	10	11.2	10.5	11.7	12.7	9.9	11.2	12.4	9	10.3	11.7	8	9.4	10.8	6.9	8.3		55	
60	9.4	10	10.3	8.8	9.6	10.2	9.1	10	10.7	7.1	8.2	9.1	8.7	9.6	10.4	8.3	9.3	10.1	7.5	8.6	9.6	6.6	7.9	9.1	5.5	6.9	8.1	60	
65	8.1	8.4	8.4	7.5	8.1	8.5	7.8	8.5	9	5.8	6.7	7.5	7.3	8.2	8.8	7	7.9	8.6	6.3	7.2	8.1	5.4	6.5	7.7	4.4	5.6	6.7	65	
70				6.4	6.8	7.1	6.7	7.2	7.7	4.7	5.5	6.2	6.2	6.9	7.5	5.9	6.7	7.3	5.2	6.1	6.9	4.4	5.4	6.4	3.4	4.6	5.5	70	
75				5.4	5.8		5.7	6.2	6.6	3.8	4.5	5.1	5.3	6	6.4	5	5.7	6.2	4.3	5.1	5.8	3.5	4.4	5.4	2.4	3.6	4.5	75	
80				4.7	4.9		4.9	5.3	5.6	2.9	3.7	4.1	4.5	5.1	5.5	4.2	4.8	5.3	3.5	4.3	4.9	2.6	3.6	4.5	1.4	2.7	3.6	80	
85							4.2	4.6	4.7	2	2.9	3.3	3.9	4.3	4.7	3.6	4.1	4.5	2.7	3.5	4.1	1.7	2.8	3.7		1.8	2.7	85	
90							3.6	3.9					2.4	3.3	3.7	4	3	3.5	3.8	1.9	2.8	3.4		2	2.9			90	
95							3.1	3.3					2.7	3.1	3.4	2.3	2.9	3.2			2.1	2.8			2.2			95	
100													2.2	2.6	2.9	1.7	2.3	2.7						2.1				100	
105													1.5	2.1	2.3									1.3				105	
110														1.4	1.6														110

t_273_00112_00.001

Lifting capacities

Forces de levage

TK

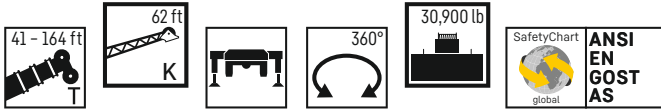

	41 ft			57 ft			72 ft			87 ft			103 ft			118 ft			134 ft			149 ft			164 ft				
	0°	20°	40°	0°	20°	40°	0°	20°	40°	0°	20°	40°	0°	20°	40°	0°	20°	40°	0°	20°	40°	0°	20°	40°	0°	20°	40°		
10	7.9																											10	
15	8.3																												15
20	8.2																												20
25	8																												25
30	7.6	6.6																											30
35	7.4	6.6																											35
40	7.1	6.5																											40
45	6.8	6.2																											45
50	6.5	5.9	5.3																										50
55	6.2	5.7	5.2																										55
60	5.9	5.5	5.1	6.4	5.8																								60
65	5.5	5.4	5	6.2	5.6	5																							65
70	5.1	5.2	4.9	5.9	5.4	4.9																							70
75	4.8	5	4.8	5.6	5.3	4.9																							75
80	4.5	4.7	4.8	5.2	5.1	4.8	5.9	5.3	4.9	6.3	5.5	4.9	6.6	5.6	4.9	6.4	5.5	4.9	6.4	5.5	4.9	6.4	5.5	4.9	6.2	5.4	4.8	80	
85	4.2	4.4	4.6	4.9	5	4.8	5.6	5.2	4.8	6.1	5.3	4.9	6.4	5.4	4.9	6.2	5.3	4.8	6.2	5.4	4.8	6.2	5.3	4.8	6.1	5.3	4.8	85	
90	4	4.1	4.3	4.7	4.7	4.8	5.3	5.1	4.8	5.9	5.2	4.8	6.2	5.3	4.8	6.1	5.3	4.8	6.1	5.3	4.8	6.1	5.3	4.8	6.1	5.3	4.8	90	
95	3.8	3.9		4.4	4.5	4.6	5	5	4.8	5.6	5.1	4.8	5.9	5.2	4.8	5.9	5.2	4.8	5.9	5.2	4.8	5.9	5.2	4.8	5.9	5.2	4.7	95	
100				4.2	4.3	4.4	4.8	4.8	4.8	5.4	5	4.8	5.8	5.1	4.8	5.8	5.1	4.7	5.8	5.1	4.7	5.8	5.1	4.7	5.8	5.1	4.7	100	
105				4	4.1		4.6	4.6	4.6	5.1	4.9	4.8	5.5	5.1	4.7	5.6	5	4.7	5.7	5.1	4.7	5.7	5	4.7	5.4	5	4.7	105	
110				3.8	3.9		4.3	4.4	4.5	4.9	4.8	4.8	5.3	5	4.7	5.5	4.9	4.7	5.6	5	4.7	5.5	5	4.7	5.4	5	4.7	110	
115							4.1	4.2		4.7	4.6	4.6	5.2	4.9	4.7	5.4	4.9	4.7	5.4	4.9	4.7	5.4	4.9	4.7	5	4.9	4.7	4.3	115
120							4	4		4.5	4.4	4.5	5	4.8	4.7	5.2	4.9	4.7	5	4.9	4.7	4.5	4.9	4.7	3.8	4.6	4.6	120	
125							3.8	3.9		4.3	4.3	4.4	4.8	4.6	4.7	5	4.8	4.7	4.6	4.8	4.7	4	4.7	4.7	3.4	4.2	4.6	125	
130										4	4.1		4.6	4.5	4.5	4.7	4.8	4.7	4.1	4.6	4.7	3.6	4.3	4.7	2.9	3.7	4.3	130	
135										3.7	3.9		4.4	4.4	4.4	4.3	4.6	4.7	3.7	4.3	4.6	3.3	3.8	4.3	2.5	3.3	3.8	135	
140										3.2			4.2	4.2		3.9	4.3	4.5	3.4	3.8	4.2	2.9	3.4	3.8	2.1	2.9	3.4	140	
145													3.9	4.1		3.6	3.9	4.1	3	3.5	3.8	2.6	3.1	3.4	1.7	2.5	3	145	
150													3.6	3.8		3.3	3.6	3.7	2.7	3.1	3.4	2.3	2.7	3.1	1.3	2.2	2.6	150	
155													3.4			3	3.3		2.4	2.8	3	1.9	2.4	2.7	1.8	2.2	2.5	155	
160																2.7	3		2.1	2.5	2.7	1.6	2.1	2.4		1.3	1.9	160	
165																2.4	2.6		1.8	2.2			1.8	2			1.4	165	
170																2.2			1.5	1.8			1.4	1.7				170	
175																			1.5									175	

† 273_00211.00.001

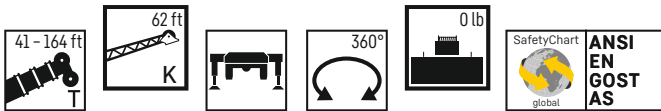

	41 ft			57 ft			72 ft			87 ft			103 ft			118 ft			134 ft			149 ft			164 ft				
	0°	20°	40°	0°	20°	40°	0°	20°	40°	0°	20°	40°	0°	20°	40°	0°	20°	40°	0°	20°	40°	0°	20°	40°	0°	20°	40°		
10	7.9																											10	
15	8.3																												15
20	8.2																												20
25	8																												25
30	7.6	6.6																											30
35	7.4	6.6																											35
40	7.1	6.5																											40
45	6.8	6.2																											45
50	6.5	5.9	5.3																										50
55	6.2	5.7	5.2																										55
60	5.9	5.5	5.1	6.4	5.8																								60
65	5.5	5.4	5	6.2	5.6	5																							65
70	5.1	5.2	4.9	5.9	5.4	4.9																							70
75	4.8	5	4.8	5.6	5.3	4.9																							75
80	4.5	4.7	4.8	5.2	5.1	4.8	5.8	5.3	4.9	6.3	5.5	4.9	6.6	5.6	4.9	6.4	5.5	4.9	6.4	5.5	4.9	6.4	5.5	4.9	6.2	5.4	4.8	80	
85	4.2	4.4	4.6	4.9	5	4.8	5.6	5.2	4.8	6.1	5.3	4.9	6.4	5.4	4.9	6.2	5.3	4.8	6.2	5.4	4.8	6.2	5.3	4.8	6.1	5.3	4.8	85	
90	4	4.1	4.3	4.4	4.7	4.8	5.4	5	4.8	5.9	5.2	4.8	6.2	5.3	4.8	6.1	5.3	4.8	6.1	5.3	4.8	6.1	5.3	4.8	6.1	5.3	4.8	90	
95	3.8	3.9		3.9	4.4	4.6	3.9	4.5	4.8	1.9	3.2	4	3.3	4.1	4.7	3	3.9	4.6	1.9	3.3	4.2							95	
100				3.4	3.8	4.1	3.4	4	4.4																				100
105				3	3.3		3	3.5	3.8																				105
110				2.6	2.7		2.6	3	3.3																				110
115							2.2	2.6																					115
120							1.8	2.1																					120
125							1.5	1.6																					125
130																													130

† 273_00212.00.001

Lifting heights

Hauteurs de levage

TK

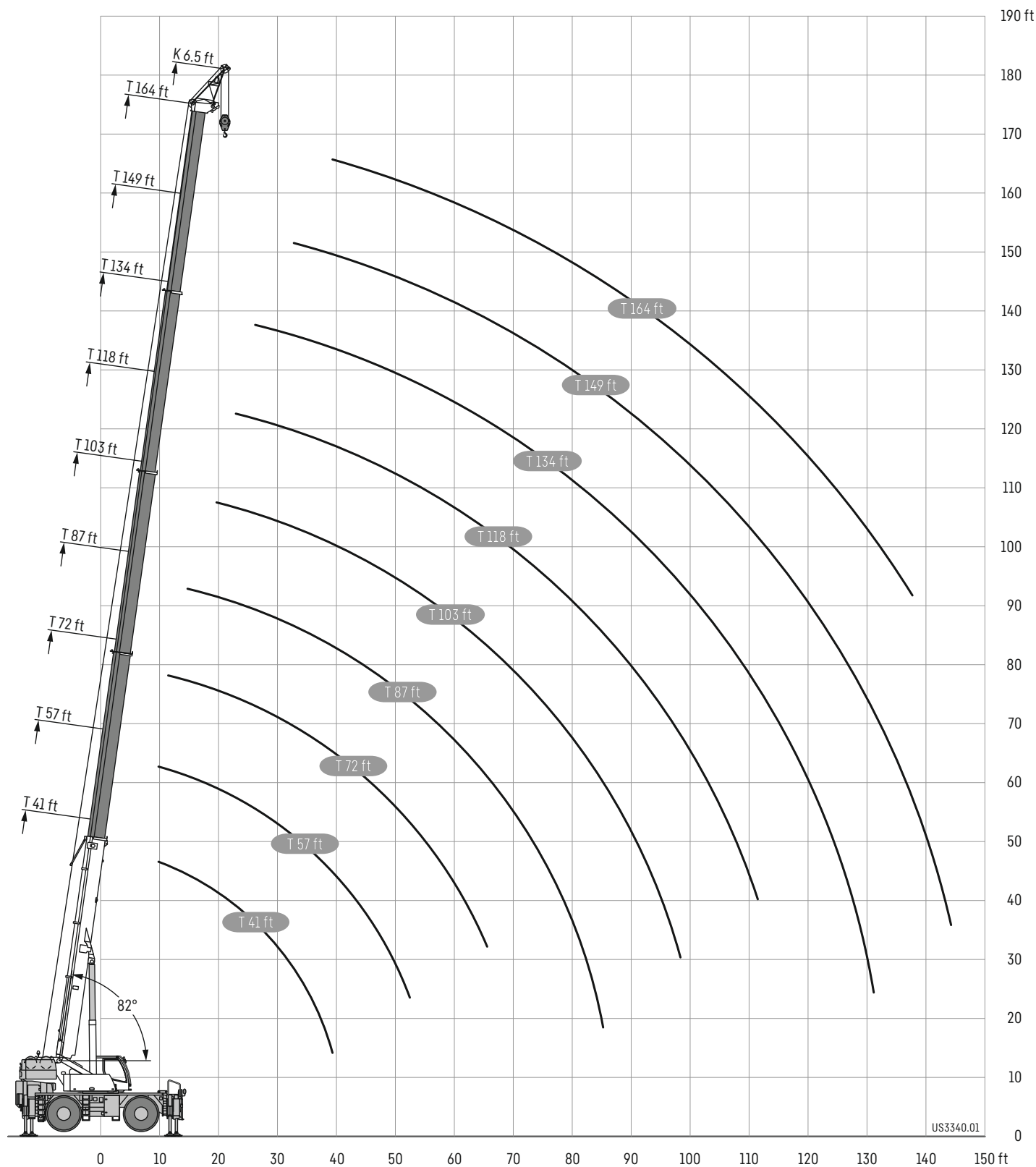

Lifting capacities

Forces de levage

TK

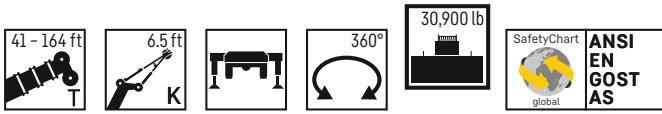

	41 ft	57 ft	72 ft	87 ft	103 ft	118 ft	134 ft	149 ft	164 ft	
	6.5 ft									
10	54.5	54.5	54.5							10
15	54.5	54.5	54.5	54.5						15
20	54.5	54.5	54.5	54.5	54.5					20
25	54.5	54.5	54.5	54.5	54	34				25
30	54.5	54.5	54.5	52.2	49.1	30.8	29.1	26.4		30
35	49.4	49.1	47.2	43.7	40.4	28.1	26.9	25	21.7	35
40	38.7	38.8	38.5	36.1	33.3	25.5	25	23.6	21.1	40
45		32.4	31.2	29.8	27.8	23.5	23.1	22.2	20.4	45
50		26.9	25.8	24.4	23.5	21.6	21.4	20.9	19.2	50
55		22.8	21.6	21.9	19.4	19.8	19.7	19.6	18	55
60			19.7	20	16.5	18.5	18.1	18.2	16.6	60
65			17.1	17.5	15.1	17	16.2	15.6	14.5	65
70			14.9	15.3	14	14.8	14	13.4	12.4	70
75				13.4	12.9	13	12.2	11.6	10.6	75
80				11.8	11.6	11.4	10.6	10.1	9.3	80
85				10.5	10.2	10	9.4	9	8.2	85
90					9.2	9	8.4	8	7.2	90
95					8.3	8.1	7.5	7.1	6.4	95
100					7.6	7.4	6.8	6.4	5.7	100
105						6.7	6.1	5.7	5	105
110						6.1	5.5	5.1	4.4	110
115						5.6	5	4.6	3.9	115
120							4.5	4.1	3.4	120
125							4.1	3.7	3	125
130							3.7	3.3	2.6	130
135								2.9	2.2	135
140								2.5	1.8	140
145								2.1		145

t_273.01111_00_000

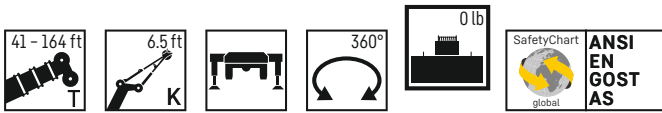

	41 ft	57 ft	72 ft	87 ft	103 ft	118 ft	134 ft	149 ft	164 ft	
	6.5 ft									
10	54.5	54.5	54.5							10
15	54.5	54.5	54.5	54.5						15
20	54.5	54.5	54.5	52.6	46.8					20
25	48.2	46	41.3	31.9	34	34				25
30	33.9	34	32.9	25.2	30	28.3	26.1	24.3		30
35	24.3	25.1	25.6	20.1	23.9	22.6	20.9	19.4	17.2	35
40	18.1	19	19.7	15.7	19.4	18.4	17	15.8	13.7	40
45		14.6	15.3	12.4	15.7	15.1	13.9	12.8	11	45
50		11.4	12	10	12.4	12	11.1	10.3	8.9	50
55		9.2	9.6	8.4	9.9	9.7	8.9	8.4	7.2	55
60			8	7.1	8.3	8	7.4	6.8	5.8	60
65			6.7	6	7	6.8	6.1	5.6	4.6	65
70			5.7	5.1	5.9	5.7	5.1	4.6	3.6	70
75				4.4	5	4.8	4.2	3.7	2.6	75
80				3.8	4.2	4	3.4	3		80
85					3.6	3.4	2.8	2.2		85
90					3	2.8	2			90
95					2.4	2.2				95
100					1.8					100

t_273.01112_00_000

Equipment

Crane carrier

Frame	Liebherr 2-axle chassis.
Outriggers	4-point supporting system, hydraulically telescopable into horizontal and vertical direction. VarioBase with inclination display and automatic support leveling.
Engine	Diesel, 6 cylinder, watercooled, make Cummins, output 194 kW (264 h.p.), max. torque 730 lb-ft. Exhaust emissions acc. to EPA/CARB or ECE-R.96. Fuel tank capacity: 93 gallons.
Gearbox	Power shift gearbox with torque converter, integrated 2-stage distribution gearbox with 3 forward and 1 reverse gear.
Axles	Front: planetary axles steerable, driven. Rear: planetary axle with differential lock, steerable, shiftable, oscillating.
Tyres	4 tyres. Tyre size: 29.5 R 25.
Steering	Hydraulic power steering, steering of the rear axle hydraulically shiftable. Special steering programs for various driving situations. Hydrostatic steering of both axles from the crane cab.
Brakes	Operation brake: hydraulic 2 circuit system, all axles equipped with disk brakes. Manual brake: hydraulic locking brake acting on 1. axle. Sustained-action brake: engine brake.
Electrical system	Modern data bus technique, 24 Volt DC, 2 batteries of 145 Ah each.

Crane superstructure

Frame	Liebherr-made, torsion-resistant, welded construction of high-tensile structural steel, single-row ball bearing slewing ring.
Crane drive	4 working motions simultaneously drivable by open oil circuits with electrically controlled „Load Sensing“. By pumps diesel-hydraulically driven.
Control	Electrical control of drives by self-centering joysticks, data transfer with Liebherr System Bus (LSB).
Hoist gear 1, Hoist gear 2	Axial piston fixed displacement motor, hoist drum with integrated planetary gear and spring-loaded static brake, actuation by open regulated oil circuit.
Luffing gear	1 differential hydraulic ram with pilot locking valve.
Slewing gear	Axial piston fixed displacement motor, planetary gear, spring-loaded static brake.
Driver's and crane operator's cab	Spacious corrosion resistant with comfort furnishings, rubber-elastically supported, with safety glazing, Operating and control elements for displacement and crane operation, air-conditioning system, climatized storage compartment. Cabin tiltable approx. 20° to rear.
Safety devices	LICCON2 safe load indicator, test system, hoist limit switch, safety valves to prevent pipe and hose ruptures.
Telescopic boom	1 base section and 4 telescopic sections. All telescopic sections extendable individually by means of the rapid-cycle telescoping system TELEMATIK. Boom length 41 ft to 164 ft.
Counterweight	30,900 lb
Rooster sheave	Foldable sidewise

Additional equipment

K	Assembly jib 6.5 ft
K	Single folding jib, 34 ft Double swing-away jib 34 ft – 62 ft Mechanical adjustment 0°; 20°; 40°

Other items of equipment available on request.

Équipement

Châssis porteur

Cadre	Châssis à 2 essieux Liebherr.
Calage	Dispositif de calage horizontal et vertical en 4 points, entièrement déployable hydrauliquement. VarioBase avec inclinomètre et mise à niveau automatique du calage.
Moteur	Diesel, 6 cylindres, marque Cummins, refroidissement par eau, puissance 194 kW (264 ch), couple maxi. 730 lb-ft. Emissions des gaz d'échappement conformes aux directives EPA/CARB ou ECE-R.96. Capacité du réservoir carburant: 93 gallons.
Boîte de vitesse	Boîte de vitesses avec convertisseur de couple, mécanisme de distribution à deux étages, avec chacun 3 rapports avant et 1 rapport arrière.
Essieux	Avant : Essieu planétaire, directeur, moteur. Arrière : Essieu planétaire avec blocage de différentiel, directeur, enclenchable, oscillant.
Pneumatiques	4 pneumatiques. Dimension des pneumatiques: 29.5 R 25.
Direction	Servo-direction hydraulique, direction de l'essieu arrière commutable hydrauliquement. Programmes de direction spéciaux pour diverses situations de conduite. Direction hydrostatique des deux essieux depuis la cabine.
Freins	Frein de service : installation hydraulique à 2 circuits, tous les essieux sont équipés de freins à disques. Frein à main : frein de stationnement hydraulique agissant sur le 1er essieu. Frein a regime continu: frein moteur.
Installation électrique	Technique moderne de transmission de données par BUS de données, courant continu 24 Volts, 2 batteries de 145 Ah chacune.

Partie tournante

Cadre	Fabrication Liebherr, construction mécanosoudée en tôle d'acier à haute résistance à grains fins. Couronne d'orientation à 1 rangée de billes.
Entraînement	4 mouvements de travail pouvant être exécutés simultanément via les circuits hydrauliques ouverts avec «Load Sensing» à commande électrique. Entraînement diesel hydraulique par des pompes.
Commande	Commande électrique des mécanismes par leviers de manoeuvre à centrage automatique, Liebherr Système Bus (LSB) pour la transmission.
Mécanisme de levage 1	Moteur hydraulique à cylindrée constante, treuil à réducteur planétaire incorporé et frein d'arrêt à ressort, en circuit hydraulique ouvert.
Mécanisme de levage 2	
Mécanisme de relevage	1 vérin différentiel, avec clapet anti-retour de sécurité.
Dispositif de rotation	Moteur à cylindrée constante à pistons axiaux, engrenage planétaire, frein d'arrêt commandé par ressort.
Cabine conducteur / du grutier	Spacieuse cabine, traitement anticorrosion, équipement «grand confort», montée sur silentbloc en caoutchouc et dotée de vitres de sécurité, instruments de commande et de contrôle pour la translation et l'utilisation de la grue, climatisation. Compartiment de rangement climatisé. Cabine inclinable de env. 20° vers l'arrière.
Dispositif de sécurité	Contrôleur de l'état de charge LICCON2, système test, fin de course de levage, soupapes de sécurité sur tubes et flexibles contre rupture.
Flèche télescopique	Un élément de base et de 4 télescopes. Chaque partie peut être télescopée individuellement à l'aide du système de télescopage séquentiel rapide TELEMATIK. Longueur de flèche: 41 ft - 164 ft.
Contrepoids	30,900 lb
Poulie en extrémité de mât	Rabattable sur le côté



































Équipement supplémentaire

K	Flechette de montage 6.5 ft
K	Fléchette pliante simple, longueur 34 ft Double flechette pliante 34 ft - 62 ft Réglage mécanique 0° ; 20° ; 40°

Autres équipements supplémentaires sur demande.

Description of symbols

Explication des symboles

	Max. capacity Capacité max.		Rope diameter Diamètre
	Max. hoist height Hauteur de levage max.		Rope length Longueur du câble
	Max. radius Portée max.		Max. single line pull Effort au brin maxi.
	Tyres Pneumatiques		Hoist gear Treuil de levage
	Hookblock/Capacity Moufle à crochet/Capacité de charge		Slewing speeds Vitesses d'orientation
	No. of sheaves Poulies		Boom length Longueur de la flèche
	No. of lines Brins		Boom position Position de la flèche
	Weight Poids		Counterweight Contrepoids
	Axle Essieu		Outriggers Calage
	Crane carrier Châssis porteur		Outriggers - free on tyres Calage - libre sur pneus
	Driving speed Vitesse de translation		Slewing gear / Working area Mécanisme d'orientation / Plage de travail
	Gradability Aptitude à gravir les pentes		over front en avant
	Transmission Boîte de vitesse		Standard Norme
	Gear Vitesse		Radius Portée
	Driving speed - Onroad gear Vitesse de translation - Vitesse de route		Telescopic boom Flèche télescopique
	Driving speed - Crawl speed Vitesse de translation - Marche lente		Mechanically adjustable folding jib Pointe pliante réglable mécaniquement
	Crane superstructure Partie tournante de la grue		Assembly jib Flechette de montage
	infinitely variable en continu		

Remarks

1. The load charts are calculated according to ANSI: ASME B30.5, EN 13000, AS 1418.5, GOST.
2. For the calculation of the load charts at least a wind speed of 30 ft/s (9 m/s, 20 mph) and regarding the load a sail area of 1 m² per ton load and a wind resistance coefficient of 1.2 on the load have been taken into account. For lifting of loads with large sail areas and/or high wind resistance coefficients the maximum wind speed as stated in the load charts has to be reduced.
3. The lifting capacities stated are valid for lifting operation only (corresponding with crane classification according to ISO 4301-1, crane group A1).
4. Lifting capacities are given in kips.
5. The weight of the hook blocks and hooks is part of the load and therefore it must be deducted from the lifting capacities.
6. Working radii are measured from the slewing centre.
7. The stated lengths of the telescopic boom are maximum values and may deviate slightly.
8. The lifting capacities given for the telescopic boom apply if the folding jib is removed.
9. Subject to modification of lifting capacities.
10. Lifting capacities above 154,100 lb/177,300 lb only with additional pulley block/special equipment.
11. The data of this brochure serves only for general information. All information is provided without warranty. Instructions for the correct commissioning of the crane please take from the operation manual and the load chart book.
12. The pictures contain also accessories and special equipment not included in the standard scope of delivery.

Remarques

1. Les tableaux des charges sont calculés selon ANSI: ASME B30.5, EN 13000, AS 1418.5, GOST.
2. Une vitesse de vent de 30 ft/s (9 m/s, 20 mph) minimum, une surface de prise au vent de 1 m² par tonne ainsi qu'un coefficient de résistance au vent de la charge 1,2 sont pris en compte pour le calcul des tableaux de charge. Lorsque des charges ayant une surface de prise au vent et/ou un coefficient de résistance au vent plus élevé(e)(s) sont levées, la vitesse de vent maximale indiquée dans les tableaux de charge doit être réduite.
3. Forces de levage pour application de grue de montage (correspond à la classification de grues selon ISO 4301-1, groupe de grues A1).
4. Les forces de levage sont données en kips.
5. Le poids du crochet de levage resp. de la moufle à crochet est une partie de la charge et doit donc être déduit de la capacité de charge.
6. Les portées sont calculées à partir de l'axe de rotation.
7. Les longueurs indiquées pour la flèche télescopique sont des valeurs maximales et peuvent légèrement varier dans la réalité.
8. Les charges indiquées pour la flèche télescopique sont valables lorsque la fléchette pliante est démontée.
9. Charges données sous réserve de modification.
10. Forces de levage plus de 154,100 lb/177,300 lb seulement avec moufle additionnel/equipement supplémentaire.
11. Les données de cette brochure sont données à titre informatif. Ces renseignements sont sans garantie. Les consignes relatives à la bonne mise en service de la grue sont disponibles dans le manuel d'utilisation et le manuel de tableaux de charge.
12. Les figures contiennent également des accessoires et des équipements spéciaux non inclus de série dans la livraison.

Customer Service

Personal. Competent. Reliable.
Personnalisé. Compétent. Fiable.



To ensure your Liebherr remains a Liebherr.

- Commission and training by experienced service technicians
- Worldwide service network with over 80 branches
- 24/7 technical support worldwide
- Fast availability of spare parts
- Attractive packages for maintenance and service

De sorte que votre Liebherr reste une Liebherr.

- Mise en route et formation effectuées par des techniciens qualifiés
- Service-Après-Vente Mondial représenté par plus de 80 correspondants
- Assistance Technique 24/24 et 7/7 jours
- Rapide disponibilité des pièces de rechanges
- Kits d'entretiens pour révisions et maintenances à un prix attractif

Proposition 65



WARNING: This product can expose you to chemicals, including exhaust emissions, including lead and lead compounds, which are known to the State of California to cause cancer, birth defects or other reproductive harm.

For more information see: www.P65warnings.ca.gov/diesel

Änderungen vorbehalten · Subject to modification · Sous réserve de modifications · Con riserva di modifiche · Salvo modificaciones · Возможны изменения

Liebherr-Werk Ehingen GmbH · Postfach 1361 · 89582 Ehingen, Germany
+49 73 91 5 02-0 · www.liebherr.com

Get Your
Contact



Printed in Germany (2)
lwe-tg-273-04-us01-2021