

Rough Terrain Crane/Grue Rough-Terrain

LRT 1090-2.1



100 US^t



154 ft



165 ft



215 ft

LIEBHERR

Table of content

Tables des matières

Technical Data/Caractéristiques technique

Dimensions/Encombrement	3
Rough Terrain Crane/Grue Rough-Terrain	4 – 5
Comfortable Workplace/Un poste de travail confortable	6
Proven Telescoping Technology/Technologie de télescopage expérimentée High functionality/Fonctionnalité accrue	7
Transportation/Transport	8
Weights/Poids Working speeds/Vitesses	9
T	10 – 14
TK	15 – 21
Equipment/Equipement	22 – 23
Description of symbols/Explication des symboles	24
Remarks/Remarques	25

Dimensions Encombrement

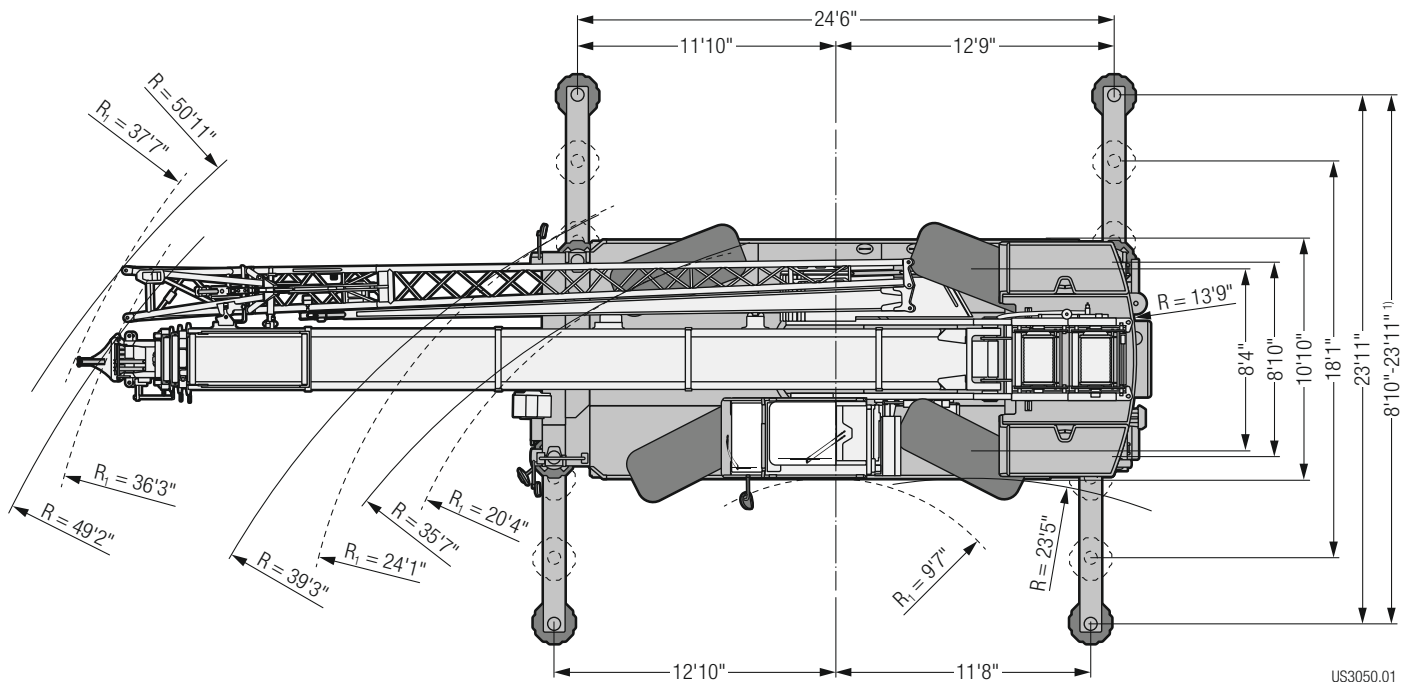
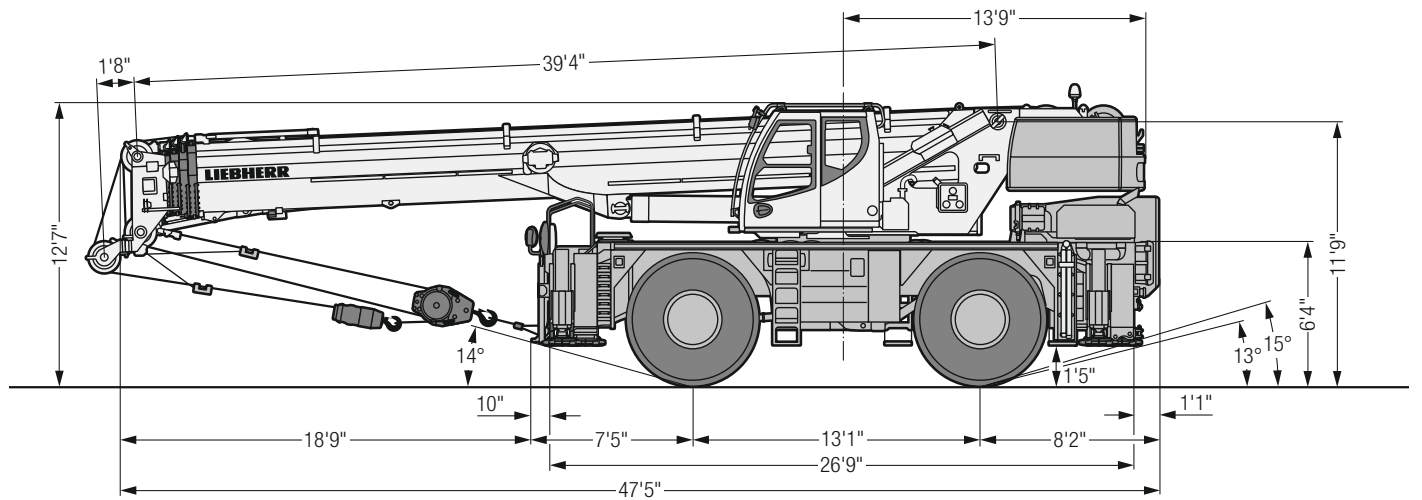

US3050.01

R_t = All-wheel steering · Direction toutes roues

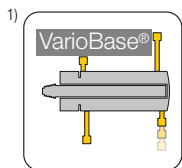

Rough Terrain Crane / Grue Rough-Terrain LRT 1090-2.1

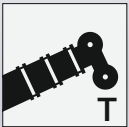

154 ft

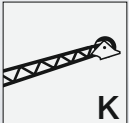

34 ft – 62 ft

€COmode

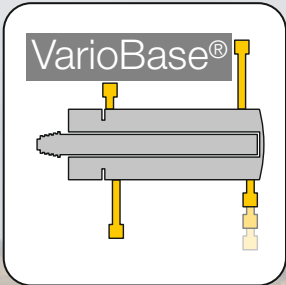



Comfortable Workplace Un poste de travail confortable



Extra wide crane cab

- For more comfort 0.7 ft wider than customary cabs
- Simple and safe handling due to clearly layed out and self-explanatory controls
- 20° tiltable backwards
- Sidewards extendable running board for safe access of the crane cab

Cabine de grue extra large

- Plus large de 0.7 ft que les autres cabines disponibles dans le commerce pour plus de confort
- Simplicité et sécurité d'utilisation grâce à des éléments de commande visibles et explicites
- Inclinaison à 20° vers l'arrière
- Marchepied déployable sur le côté pour un accès sécurisé à la cabine de grue

Proven telescoping technology Technologie de télescopage expérimentée

Fast telescoping with rope pulling technology

- Two stage hydraulic cylinder with rope extending mechanism
- Fast telescoping to any arbitrary length
- Simple extending with two telescoping paths: strong or long

Rapidité de télescopage grâce à la technique de traction par câbles

- Vérin hydraulique à deux niveaux doté d'un mécanisme d'extension de câble
- Télescopage rapide à la longueur souhaitée
- Simplicité de déploiement avec deux chemins de télescopage : puissant ou long

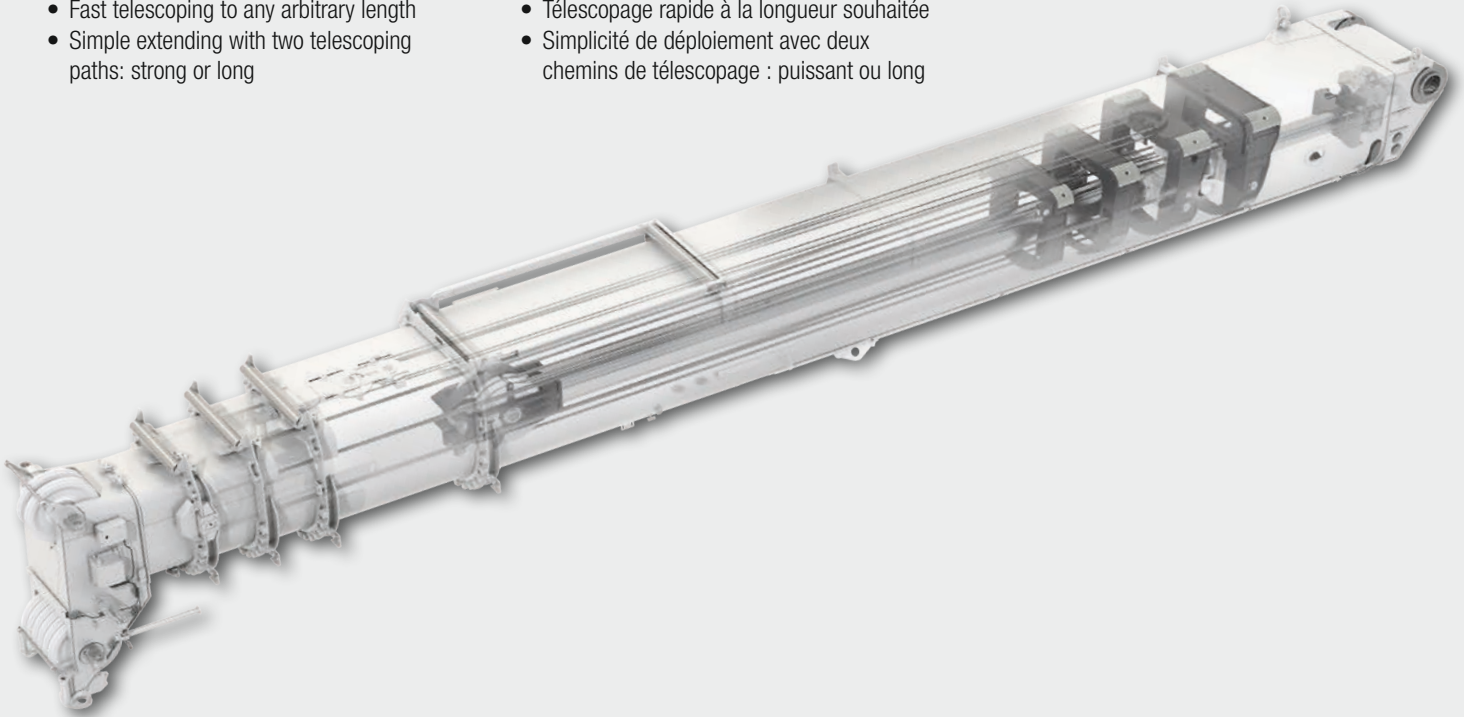

High functionality/Fonctionnalité accrue



Safe and easy operation Sécurité et simplicité d'utilisation

Automatic support leveling
Mise à niveau automatique du calage

Transportation Transport

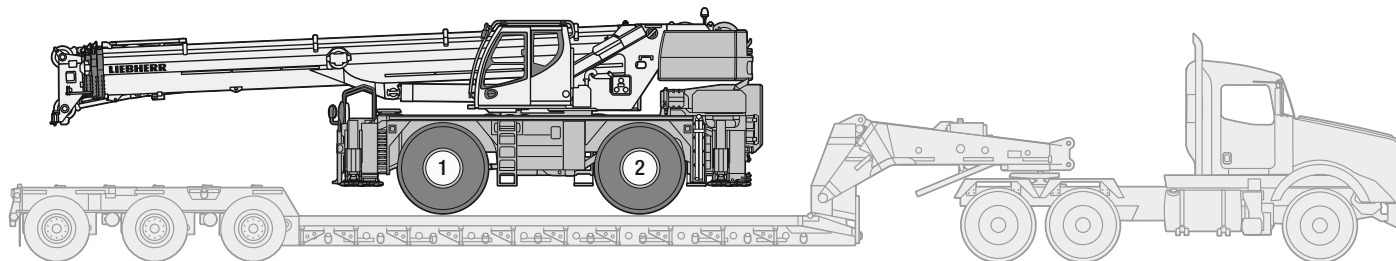

US3092.02

Basic unit/Machine de base

Without ballast, inclusive auxiliary winch,
boom nose, boom position at -2.5°

Sans lest, avec treuil auxiliaire, poulie en
extrémité de mât, Position de la flèche à -2,5°

Total weight
Poids total

85,878 lbs



57,223 lbs



28,655 lbs

All weights are to be understood with a difference of ±2.5 % / Tous les poids sont indiqués avec une différence de ±2,5 %

Crane superstructure/Partie tournante



+26,455 lbs

-8,565 lbs

+35,020 lbs

Hydraulic ballasting device
Dispositif de lestage hydraulique

+915 lbs

+1,122 lbs

-207 lbs

Working attachment/Equipement de travail



+3,452 lbs

+5,692 lbs

-2,240 lbs

200,000 lbs



+1,676 lbs

+1,991 lbs

-315 lbs

142,419 lbs



+1,169 lbs

+1,387 lbs

-218 lbs

93,256 lbs



+992 lbs

+1,177 lbs

-185 lbs

41,226 lbs



+662 lbs

+785 lbs

-123 lbs

13,889 lbs



+309 lbs

+366 lbs

-57 lbs

* Transportation position/Position de transport

Weights Poids



Hook block/Moufles à crochet

Load lbs Forces de levage lbs		No. of sheaves Poulies	No. of lines Brins	Weight lbs Poids lbs
200,000		7	14	1,676
142,419		5	11	1,169
93,256		3	7	992
41,226		1	3	661
13,889		–	1	309

Working speeds Vitesses

Crane carrier/Châssis porteur

	mph min.	mph max.	%
29.5 R 25	0 – 1.2	15.5	> 60

Theoretical gradeability/Aptitude théorique en pente

	3 / R1
	3 / R1

Crane superstructure/Partie tournante

Drive Mécanismes	infinitely variable en continu	Rope diameter / length Diamètre / Longueur du câble	Max. single line pull Effort au brin maxi.
	0 – 456 ft/min single line ft/min au brin simple	0.67" / 787 ft	14,162 lbs
	0 – 456 ft/min single line ft/min au brin simple	0.67" / 607 ft	14,162 lbs
	0 – 1.5 rpm		
	approx. 47 seconds to reach 80.5° boom angle env. 47 s jusqu'à 80,5°		
	approx. 125 seconds for boom extension from 39 ft – 154 ft env. 125 s pour passer de 39 ft – 154 ft		

Lifting capacities Forces de levage

T

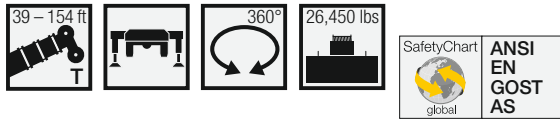

	39 ft	54 ft	68 ft	97 ft	126 ft	140 ft	154 ft	
8	200**							8
10	175.1*							10
15	131.8	105.8	95.9					15
20	105.2	101.5	91.1	42.3				20
25	79.8	74.8	67.5	42.3	37	27.3		25
30	58.9	55.2	49.9	42.3	36.4	26.6	24.9	30
35		41.2	42.3	38.1	33.2	25.3	23.6	35
40		31.7	36.7	34.6	29.7	23.5	22.1	40
45		25	29.6	29.7	25.4	21.8	20.5	45
50			24.4	24.6	21.5	20.3	19	50
55			20.4	20.7	18.5	18.8	17.4	55
60			17.3	17.6	17.2	16.5	15.3	60
65				15	15.3	14	12.8	65
70				12.9	13.1	11.9	10.8	70
75				11.1	11.3	10.2	9.3	75
80				9.7	10	8.9	8.1	80
85				8.7	8.8	7.9	7	85
90					7.9	7	6.1	90
95					7.1	6.2	5.3	95
100					6.3	5.4	4.7	100
105					5.7	4.8	4	105
110					5.2	4.3	3.4	110
115					4.7	3.7	3	115
120						3.3	2.5	120
125						2.8	2	125
130						2.3		130

* only with additional pulley block / seulement avec moufle additionnel

** only with additional special equipment / seulement avec equipment supplémentaire

t_262_00011_00_003

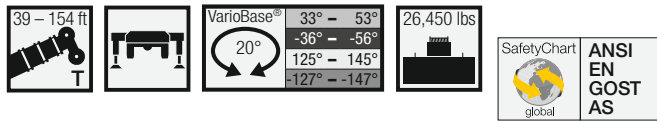

	39 ft	54 ft	68 ft	97 ft	126 ft	140 ft	154 ft	
10	154.1	105.8	95.9					10
15	131.8	105.8	95.9	42.3				15
20	105.2	101.4	91.5	42.3	37			20
25	79.6	78	75.4	42.3	37	27.3		25
30	62.6	61.1	57.1	42.3	36.4	26.7	24.9	30
35		47.2	45	41.7	33.3	25.4	23.6	35
40		37.7	41.9	35.3	30	23.6	22	40
45		30.9	34.6	33.3	27.3	21.8	20.5	45
50			28.9	29.5	23.8	20.3	19	50
55			24.5	25.4	20.7	19	17.6	55
60			21.2	21.8	18.1	17.6	16.3	60
65				19	16.1	16.5	15	65
70				16.8	15	15.2	13.7	70
75				15	13.9	13.7	12.1	75
80				13.2	13.2	11.9	10.8	80
85				11.9	12.3	10.6	9.5	85
90					11	9.5	8.4	90
95					10.1	8.6	7.3	95
100					9.3	7.7	6.6	100
105					8.4	6.8	5.7	105
110					7.7	6.2	5.1	110
115					7.1	5.5	4.4	115
120						5.1	4	120
125						4.6	3.5	125
130						4.2	3.1	130
135							2.6	135
140							2.4	140
145							2	145

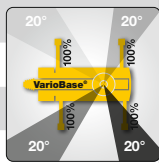

+18,9%

LRT_1090-2.1_Mult_2

Lifting capacities

Forces de levage

T

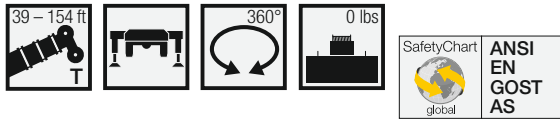

	39 ft	54 ft	68 ft	97 ft	126 ft	140 ft	154 ft	
10	154.1	105.8	95.9					10
15	127.6	102.7	94.6	42.3				15
20	74.5	62.7	54.5	42.3	37			20
25	48.3	40.8	42.3	35.3	32	27.3		25
30	32	28.5	32.8	30.5	27.8	25.2	22.8	30
35		19.6	25	23.9	22.3	20	17.9	35
40		13.7	18.8	19	18.2	16.1	14.3	40
45		9.6	14.3	14.7	14.8	13.1	11.5	45
50			11	11.4	11.8	10.5	9.2	50
55			8.8	9.2	9.4	8.4	7.4	55
60			7.3	7.6	7.8	6.8	5.8	60
65				6.3	6.5	5.5	4.6	65
70				5.3	5.5	4.5	3.5	70
75				4.4	4.6	3.6	2.4	75
80				3.6	3.8	2.8		80
85				3	3.1	1.9		85
90					2.5			90
95					1.8			95

t_262_00012_00_002

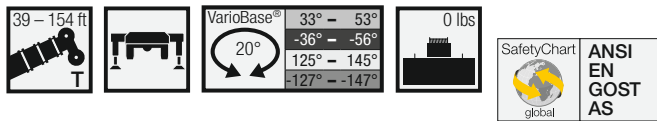

	39 ft	54 ft	68 ft	97 ft	126 ft	140 ft	154 ft	
10	154.1	105.8	95.9					10
15	127.2	105.8	95.9	42.3				15
20	88.8	74.7	61.3	42.3	37			20
25	61.1	49.6	42.3	36.8	32.2	27.3		25
30	43.9	35.7	38.4	33.3	28.7	25.8	22.7	30
35		26.9	30.2	26.9	23.8	21.2	18.5	35
40		20.9	24.5	22	19.8	17.4	15.2	40
45		16.5	20.3	18.5	16.8	14.6	12.6	45
50			17	15.7	14.3	12.3	10.6	50
55			13.9	13.2	12.3	10.4	8.8	55
60			11.7	11.2	10.6	8.8	7.3	60
65				9.7	9	7.5	6	65
70				8.4	7.9	6.2	4.9	70
75				7.1	6.8	5.3	3.7	75
80				6.2	5.7	4.4	2.9	80
85				5.3	5.1	3.5	2	85
90					4.2	2.9	1.1	90
95					3.5	2	0.4	95
100					3.1	1.3		100
105					2.6	0.9		105
110					2.2	0.4		110
115					1.8			115

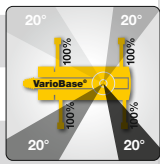

+26,3%

LRT_1090-2.1_Multi_2

Lifting capacities

Forces de levage

T



ANSI
EN
GOST
AS

	39 ft	54 ft	68 ft	82 ft	
13	44.3				13
14	41.4				14
15	39				15
20	28.9	30.4			20
25	22.3	23.4	24		25
30	17.4	18.3	19		30
35		15	15.4	15.7	35
40		12.1	13	12.1	40
45		9.7	10.6	9.9	45
50			8.6	8.4	50
55			7.1	7.1	55
60			6.2	6	60
65				5.1	65
70				4.2	70
75				3.5	75

n.v. = over front / en avant

LRT_1090-2.1_Multi_2



ANSI
EN
GOST
AS

	39 ft	54 ft	68 ft	82 ft	
15	29.8				15
20	19.4				20
25	12.6	18.1			25
30	8.6	12.6	11.9		30
35		8.8	8.8		35
40		6.2	6.4	6.2	40
45		4	4	4	45
50		2.4	2.4	2.4	50
55			1.3	1.3	55
			0.4	0.4	

n.v. = over front / en avant

LRT_1090-2.1_Multi_2

Lifting capacities

Forces de levage

T

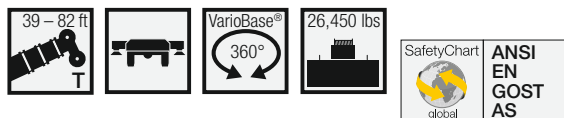

	39 ft	54 ft	68 ft	82 ft	
20	17.9	18.7			20
25	12.8	13.7	13.4		25
30	9	10.1	10.4		30
35		7.5	7.9	7.5	35
40		5.3	6.2	6	40
45		3.3	4	4.4	45
50			2.4	2.4	50
55			1.3	1.5	55
60			0.9	0.9	60

LRT_1090-2.1_Multi_2

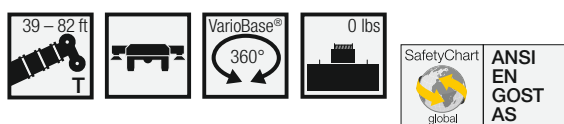

	39 ft	54 ft	68 ft	
15	8,2			15
20	3,1	3,3		20
25	0,4	1,1	1,1	25

LRT_1090-2.1_Multi_2

Lifting heights Hauteurs de levage

T

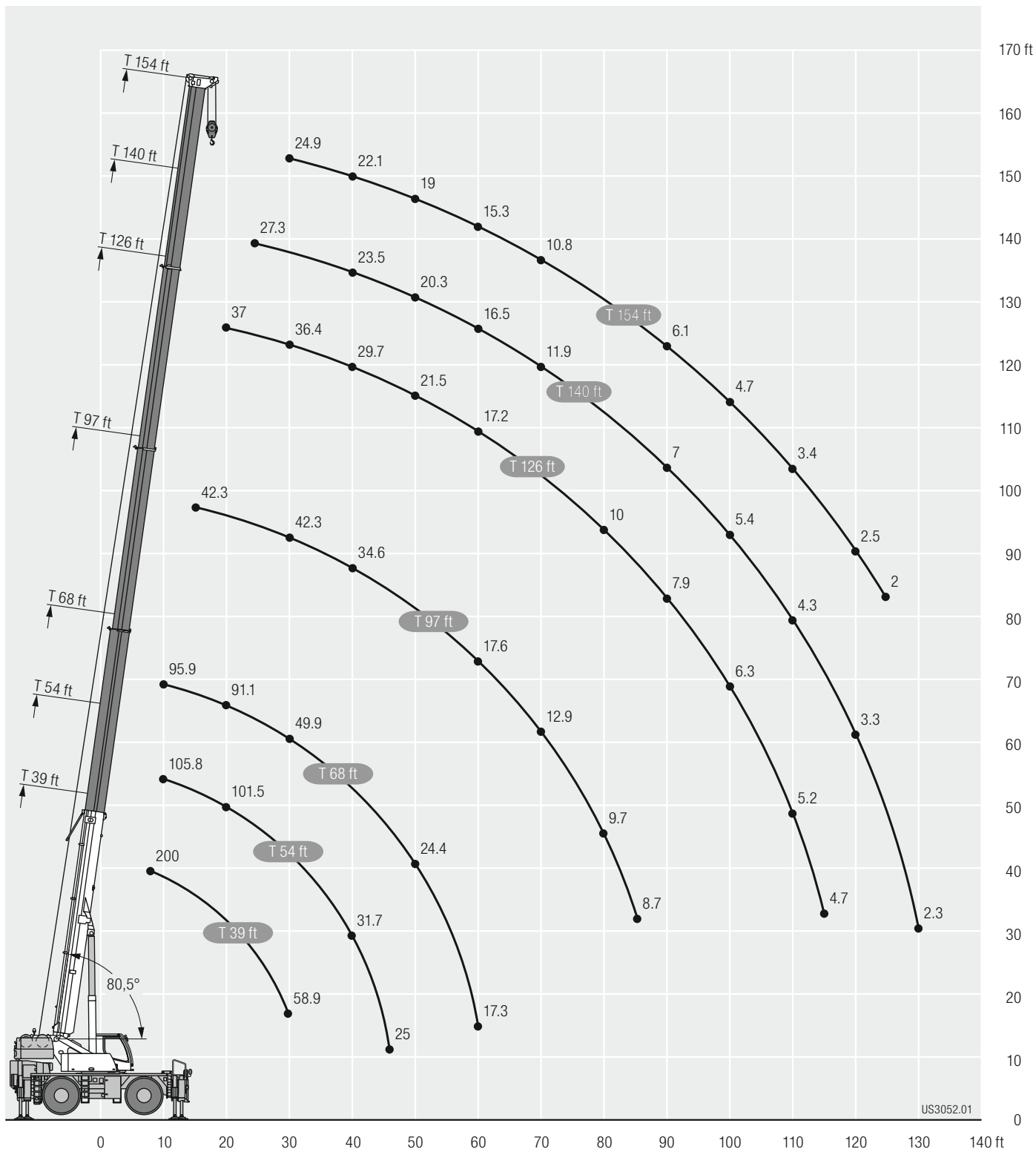

Lifting capacities Forces de levage

TK

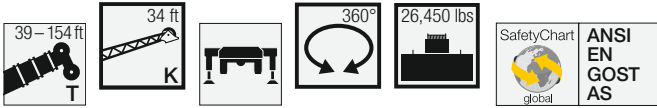

	39 ft 34 ft			54 ft 34 ft			68 ft 34 ft			97 ft 34 ft			126 ft 34 ft			140 ft 34 ft			154 ft 34 ft				
	0°	20°	40°	0°	20°	40°	0°	20°	40°	0°	20°	40°	0°	20°	40°	0°	20°	40°	0°	20°	40°		
10	25			25			25															10	
15	25			25			25															15	
20	24.4	20.1		25	20.3		25			25												20	
25	22.7	18.4	15	24.4	19.7		25	20.3		25			21.7									25	
30	20.2	17	14.4	23.1	18.3	14.9	24.4	19.3	15	25	20.3		21.8			16				13.2		30	
35	18	15.8	13.7	21.1	17.1	14.3	23.4	18.2	14.7	25	19.8	15	21.8			15.2				12.9		35	
40	15.9	14.8	13.2	19.1	16.1	13.7	21.8	17.2	14.2	24.5	18.9	14.8	20.8	17.9		14.5	13			12.5		40	
45	14	13.6	12.8	17.3	15.2	13.3	20	16.3	13.7	23.7	18	14.4	19.7	17.2	14	13.8	12.3			12.1	11.2	45	
50	12.5	12.5	12.1	15.6	14.3	12.9	18.4	15.5	13.4	21.7	17.2	14	18.5	16.6	13.7	13	11.6	10.7		11.6	10.7	50	
55	11.3	11.6	11.4	14	13.3	12.5	16.8	14.8	13.1	18.7	16.5	13.7	17.2	16	13.5	12.2	11	10.2		11.1	10.2	9.7	55
60	10.3	10.8	10.9	12.8	12.4	12	15.3	13.9	12.8	17.4	15.9	13.4	15.5	15.3	13.2	11.5	10.4	9.7		10.6	9.8	9.3	60
65	9.4	10.3		11.7	11.7	11.4	14	13.1	12.4	16	14.7	13.2	13.4	14.3	13	10.9	9.9	9.3		10.1	9.5	9	65
70				10.7	11.1	11	12.9	12.4	11.9	14	13.9	12.8	11.3	12.5	12.6	10.2	9.5	9		9.7	9.1	8.7	70
75				9.9	10.6		12	11.8	11.4	12.1	12.9	12.5	9.6	10.6	11.5	9.5	9	8.7		9.3	8.8	8.5	75
80				9.3			11	11.2	11.1	10.6	11.3	11.8	8.9	9.2	9.8	9	8.6	8.4		8.3	8.4	8.2	80
85							9.8	10.1		9.4	9.9	10.3	8.4	8.1	8.6	8	8.3	8		7.3	8.1	7.9	85
90							8.9	9.1		8.4	8.8	9.2	7.9	7.6	7.6	7.1	7.7	7.7		6.4	7.1	7.5	90
95							8.1			7.6	8	8.2	7.2	7.3	7.2	6.3	6.9	7.3		5.6	6.2	6.8	95
100										6.8	7.2	7.3	6.5	6.9	6.9	5.5	6.1	6.5		4.9	5.5	5.9	100
105										6.2	6.4	6.6	5.8	6.2	6.5	4.9	5.4	5.7		4.2	4.8	5.2	105
110										5.6	5.8		5.2	5.6	5.8	4.3	4.8	5.1		3.6	4.2	4.5	110
115										5	5.2		4.7	5	5.2	3.8	4.2	4.5		3.1	3.6	3.9	115
120										4.6	4.7		4.2	4.5	4.7	3.3	3.7	3.9		2.6	3.1	3.4	120
125													3.8	4	4.2	2.9	3.2	3.4		2.1	2.6	2.9	125
130													3.4	3.6		2.4	2.8	3			2.1	2.4	130
135													3	3.2		2	2.3	2.5				1.9	135
140													2.6	2.8			1.9	2					140
145													2.3	2.4									145
150													1.9										150

t_262_00111_00_001

Lifting capacities Forces de levage

TK

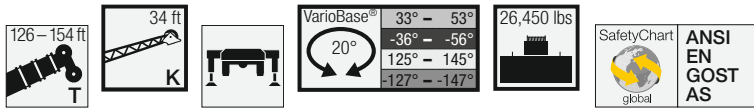

↙ ↘	126 ft			140 ft			154 ft			↙ ↘
	0°	20°	40°	0°	20°	40°	0°	20°	40°	
25	21.6									25
30	21.8			15.9			13.2			30
35	21.8			15.2			12.8			35
40	20.7	17.9		14.6	13		12.6			40
45	19.6	17.2	14.1	13.7	12.3		12.1	11.2		45
50	18.5	16.5	13.7	13	11.7	10.6	11.7	10.6		50
55	17.4	16.1	13.4	12.3	11	10.1	11	10.1	9.7	55
60	16.1	15.2	13.2	11.5	10.4	9.7	10.6	9.9	9.3	60
65	15	14.6	13	10.8	9.9	9.3	10.1	9.5	9	65
70	13.4	13.7	12.6	10.1	9.5	9	9.7	9	8.8	70
75	11.9	13	12.3	9.5	9	8.6	9.3	8.8	8.4	75
80	10.6	11.5	11.9	9	8.6	8.4	8.8	8.4	8.2	80
85	9.5	10.4	11	8.6	8.4	8.2	8.4	8.2	7.9	85
90	8.4	9.3	9.9	8.2	7.9	7.7	7.9	7.7	7.7	90
95	7.5	8.2	8.8	7.9	7.5	7.5	7.1	7.5	7.5	95
100	7.1	7.3	7.9	7.5	7.3	7.1	6.4	7.1	7.1	100
105	6.8	6.6	7.1	6.8	6.8	6.8	5.7	6.4	6.8	105
110	6.4	6.4	6.4	6.2	6.6	6.6	5.1	5.5	6.2	110
115	6.2	6.2	6.2	5.5	6	6.4	4.4	4.9	5.3	115
120	6	6	6	4.9	5.3	5.7	3.7	4.4	4.6	120
125	5.5	5.5	5.7	4.4	4.9	5.1	3.3	3.7	4.2	125
130	5.1	5.3	5.3	4	4.2	4.4	2.9	3.3	3.5	130
135	4.6	4.9		3.5	3.7	4	2.4	2.9	3.1	135
140	4.2	4.4		3.1	3.3	3.5	2	2.4	2.6	140
145	4	4		2.6	2.9		1.5	2	2.2	145
150	3.5			2.4	2.6		1.1	1.5	1.8	150
155				2	2.2		0.7	1.1	1.3	155
160				1.8	2		0.4	0.7		160
165				1.5				0.4		165
166										166
170										170
175										175
180										180

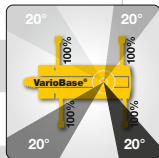

LRT_1090-2.1_Multi_2

Lifting capacities

Forces de levage

TK

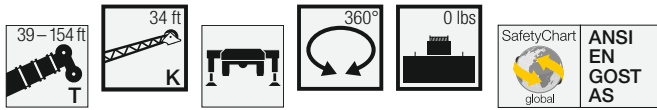

	39 ft 34 ft			54 ft 34 ft			68 ft 34 ft			97 ft 34 ft			126 ft 34 ft			140 ft 34 ft			154 ft 34 ft				
	0°	20°	40°	0°	20°	40°	0°	20°	40°	0°	20°	40°	0°	20°	40°	0°	20°	40°	0°	20°	40°		
	10	25			25			25															
15	25			25			25															15	
20	24.4	20.1		25	20.3		25			25												20	
25	22.7	18.4	15	24.4	19.7		25	20.3		25			21.7									25	
30	20.2	17	14.4	23.1	18.3	14.9	24.4	19.3	15	25	20.3		21.3			16				13.2		30	
35	18	15.8	13.7	21.1	17.1	14.3	23.3	18.2	14.7	22.6	19.8	15	17.4			15.2				12.9		35	
40	15.9	14.8	13.2	19	16.1	13.7	20.6	17.2	14.2	18.5	18.6	14.8	15.3	16.4		14.3	13			12.4		40	
45	14	13.6	12.8	15.1	15.2	13.3	17	16.3	13.7	15.4	17	14.4	13.9	13.3	14	12.1	12.3			10.6	11.2	45	
50	12.5	12.5	12.1	11.7	13.4	12.9	13.7	15.1	13.4	12.9	14.4	13.9	11.7	11.9	12.5	9.9	11.4	10.7		8.6	10.3	50	
55	11.3	11.6	11.4	9.3	10.5	11.5	11	12.2	12.9	10.3	11.7	12.9	9.8	11	10.3	8.2	9.6	10.2		6.9	8.5	9.6	55
60	9.8	10.3	10.5	7.6	8.5	9.2	9.1	10	10.7	8.6	9.6	10.5	8.2	9.3	9.7	6.7	8	9.2		5.5	7	8.2	60
65	8.4	8.6		6.3	7	7.5	7.7	8.4	9	7.3	8.1	8.8	6.9	7.8	8.5	5.4	6.7	7.7		4.3	5.6	6.8	65
70				5.2	5.7	6	6.6	7.2	7.6	6.1	6.9	7.5	5.8	6.6	7.2	4.4	5.5	6.5		3.2	4.5	5.5	70
75				4.3	4.6		5.6	6.1	6.4	5.2	5.8	6.4	4.8	5.6	6.2	3.4	4.5	5.3		2	3.5	4.5	75
80				3.4			4.8	5.2	5.4	4.4	5	5.4	4	4.7	5.2	2.5	3.6	4.3			2.6	3.5	80
85							4.1	4.4		3.7	4.2	4.6	3.3	3.9	4.4		2.7	3.5				2.6	85
90							3.5	3.7		3.1	3.5	3.8	2.6	3.3	3.7		1.9	2.7					90
95							3			2.5	3	3.2	1.8	2.6	3.1			1.8					95
100										1.8	2.3	2.6		1.9	2.5								100
105												1.9											105

t_262_00112_00_001

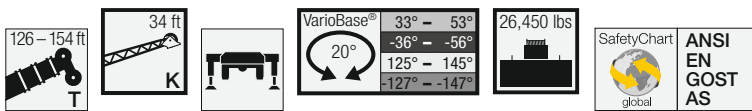

	126 ft 34 ft			140 ft 34 ft			154 ft 34 ft			
	0°	20°	40°	0°	20°	40°	0°	20°	40°	
	25	21.6								
30	21.8			15.9			13.2			30
35	18.1			15.2			12.8			35
40	15.4	17		14.6	13		12.6			40
45	14.3	14.1	14.1	13	12.3		11.2	11.2		45
50	13	11.9	13.4	11	11.7	10.6	9.3	10.6		50
55	11	11	11.5	9.3	10.6	10.1	7.7	9.3	9.7	55
60	9.7	10.6	9.7	7.9	9	9.7	6.4	7.7	9	60
65	8.4	9.3	9.3	6.6	7.7	8.8	5.3	6.6	7.7	65
70	7.3	8.2	9	5.5	6.6	7.5	4.4	5.5	6.4	70
75	6.2	7.1	7.7	4.6	5.5	6.4	3.5	4.4	5.3	75
80	5.3	6.2	6.8	3.7	4.6	5.5	2.6	3.5	4.4	80
85	4.6	5.3	6	3.1	4	4.6	1.5	2.9	3.5	85
90	4	4.6	5.1	2.4	3.1	3.7	0.9	2	2.9	90
95	3.3	4	4.4	1.5	2.6	3.1	0.4	1.1	2	95
100	2.6	3.3	3.7	0.9	1.8	2.4				100
105	2.2	2.6	3.1	0.4	1.1	1.8	0.7	1.1		105
110	1.5	2.2	2.6		0.7	1.1			0.7	110
115	1.1	1.8	2			0.7				115
120	0.7	1.1	1.3							120
125	0.4	0.7	0.9							125
130		0.4	0.4							130

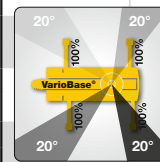

LRT_1090-2.1_Multi_2

Lifting capacities Forces de levage

TK

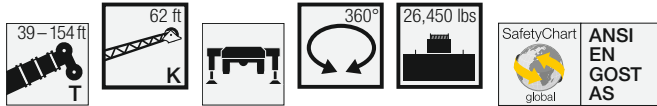

↙ ↘	39 ft 62 ft			54 ft 62 ft			68 ft 62 ft			97 ft 62 ft			126 ft 62 ft			140 ft 62 ft			154 ft 62 ft			↙ ↘
	0°	20°	40°	0°	20°	40°	0°	20°	40°	0°	20°	40°	0°	20°	40°	0°	20°	40°	0°	20°	40°	
10	7.9																					10
15	8.3			8.1			7.9															15
20	8.2			8.3			8.3			7.9												20
25	7.9			8.2			8.2			8.2			7.9									25
30	7.6	6.6		7.9			8.1			8.3			8.2			7.2						30
35	7.3	6.6		7.6	6.6		7.9	6.6		8.2			8.3			7.3			6.6			35
40	7	6.4		7.4	6.6		7.6	6.6		8.1	6.6		8.2			7.4			6.7			40
45	6.7	6.2		7.1	6.4		7.4	6.6		7.9	6.6		8.2			7.6			6.8			45
50	6.5	5.9	5.3	6.8	6.2	5.3	7.2	6.3		7.7	6.5		8	6.4		7.4			6.9			50
55	6.2	5.7	5.2	6.6	5.9	5.2	6.9	6.1	5.3	7.5	6.3		7.7	6.2		7.2	6		6.9			55
60	5.8	5.5	5	6.4	5.7	5.1	6.7	5.9	5.2	7.3	6.1	5.2	7.5	6.1		7.1	5.9		6.8	5.8		60
65	5.4	5.3	4.9	6.1	5.5	5	6.5	5.7	5.1	7.1	5.9	5.1	7.3	5.9	5.1	6.9	5.8		6.6	5.7		65
70	5	5.2	4.9	5.8	5.4	4.9	6.3	5.5	5	6.9	5.8	5	7	5.8	5	6.7	5.6	5	6.5	5.6		70
75	4.7	4.9	4.8	5.4	5.2	4.8	6	5.4	4.9	6.7	5.6	5	6.8	5.7	5	6.5	5.5	4.9	6.4	5.5	4.9	75
80	4.4	4.6	4.8	5.1	5.1	4.8	5.7	5.3	4.9	6.5	5.5	4.9	6.6	5.5	4.9	6.4	5.4	4.9	6.2	5.4	4.8	80
85	4.2	4.3	4.5	4.8	4.9	4.8	5.4	5.2	4.8	6.3	5.4	4.9	6.4	5.4	4.9	6.2	5.3	4.8	6.1	5.3	4.8	85
90	3.9	4		4.5	4.6	4.7	5.1	5	4.8	6	5.3	4.8	6.2	5.3	4.8	6	5.2	4.8	5.9	5.2	4.7	90
95				4.3	4.4	4.5	4.9	4.9	4.8	5.8	5.2	4.8	6	5.2	4.8	5.9	5.2	4.7	5.7	5.1	4.7	95
100				4.1	4.2		4.6	4.6	4.7	5.6	5.1	4.8	5.6	5.2	4.8	5.7	5.1	4.7	5.3	5.1	4.7	100
105				3.9	4		4.4	4.4	4.5	5.4	5	4.8	5.4	5.1	4.7	5.4	5	4.7	4.7	5	4.7	105
110							4.2	4.2	4.4	5.2	4.9	4.8	5.2	5	4.7	4.9	4.9	4.7	4.1	4.9	4.6	110
115							4	4.1		5	4.8	4.8	5	4.8	4.7	4.3	4.8	4.7	3.6	4.5	4.6	115
120							3.9	3.9		4.8	4.7	4.7	4.6	4.7	4.6	3.8	4.6	4.6	3	4	4.5	120
125										4.6	4.5	4.6	4.2	4.5	4.5	3.4	4.1	4.5	2.5	3.5	4.1	125
130										4.3	4.4	4.4	3.9	4.3	4.4	3	3.7	4.1	2.1	3	3.6	130
135										3.9	4.2		3.5	3.9	4.3	2.6	3.2	3.7		2.6	3.2	135
140										3.6	3.8		3.1	3.6	3.9	2.3	2.9	3.3		2.1	2.7	140
145										3.3	3.5		2.8	3.2	3.5	1.9	2.5	2.9			2.3	145
150										2.9			2.5	2.9	3.1		2.1	2.5			1.8	150
155													2.2	2.5	2.7			2.1				155
160													1.8	2.2								160
165														1.9								165

t_262_00211_00_001

Lifting capacities Forces de levage

TK

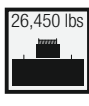
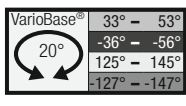
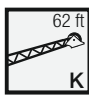

Height (ft)	126 ft			140 ft			154 ft			Height (ft)
	0°	20°	40°	0°	20°	40°	0°	20°	40°	
25	7.9									25
30	8.2			7.3						30
35	8.2			7.3			6.6			35
40	8.2			7.5			6.8			40
45	8.2			7.5			6.8			45
50	7.9	6.4		7.5			6.8			50
55	7.7	6.2		7.3	6		6.8			55
60	7.5	6		7.1	6		6.8	5.7		60
65	7.3	6	5.1	6.8	5.7		6.6	5.7		65
70	7.1	5.7	5.1	6.6	5.7	5.1	6.6	5.5		70
75	6.8	5.7	4.9	6.6	5.5	4.9	6.4	5.5	4.9	75
80	6.6	5.5	4.9	6.4	5.5	4.9	6.2	5.3	4.9	80
85	6.4	5.5	4.9	6.2	5.3	4.9	6.2	5.3	4.9	85
90	6.2	5.3	4.9	6	5.3	4.9	6	5.3	4.9	90
95	6.2	5.3	4.9	6	5.1	4.9	5.7	5.1	4.6	95
100	6	5.1	4.9	5.7	5.1	4.6	5.5	5.1	4.6	100
105	5.7	5.1	4.6	5.5	5.1	4.6	5.5	5.1	4.6	105
110	5.5	5.1	4.6	5.3	4.9	4.6	5.3	4.9	4.6	110
115	5.3	4.9	4.6	5.1	4.9	4.6	4.6	4.9	4.6	115
120	4.9	4.9	4.6	5.1	4.6	4.6	4.2	4.6	4.6	120
125	4.6	4.9	4.6	4.9	4.6	4.4	3.7	4.6	4.4	125
130	4.4	4.4	4.6	4.4	4.4	4.4	3.1	4.2	4.4	130
135	4.2	4.2	4.6	4	4.4	4.4	2.9	3.5	4.2	135
140	4.2	4.2	4.2	3.5	4.2	4.2	2.4	3.1	3.7	140
145	4	4	4	3.1	3.7	4.2	2	2.6	3.3	145
150	3.7	3.7	4	2.6	3.3	3.7	1.8	2.4	2.9	150
155	3.5	3.7	3.7	2.4	2.9	3.3	1.3	2	2.4	155
160	3.1	3.5	2.2	2.2	2.6	2.9	0.9	1.5	2	160
165	2.9	3.1		1.8	2.2	2.4	0.4	1.1	1.5	165
170	2.6	2.9		1.5	2	2.2		0.7	1.1	170
175	2.4	2.4		1.3	1.8			0.4	0.7	175
180	2.2			1.1	1.3				0.4	180
185				0.9	1.1					185
190										190
195										195
200										200
205										205
210										210
215										215

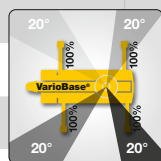

LRT_1090-2.1_Multi_2

Lifting capacities Forces de levage

TK

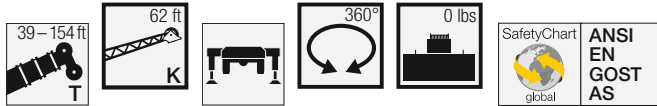

	39 ft 62 ft			54 ft 62 ft			68 ft 62 ft			97 ft 62 ft			126 ft 62 ft			140 ft 62 ft			154 ft 62 ft			
	0°	20°	40°	0°	20°	40°	0°	20°	40°	0°	20°	40°	0°	20°	40°	0°	20°	40°	0°	20°	40°	
10	7.9						7.9															10
15	8.3						8.3															15
20	8.2						8.3			7.9												20
25	7.9						8.2			8.2												25
30	7.6	6.6					7.9			8.1						7.9						30
35	7.3	6.6					7.6	6.6		7.9	6.6					8.3					6.6	35
40	7	6.4					7.4	6.6		7.6	6.6					8.2					7.4	40
45	6.7	6.2					7.1	6.4		7.4	6.6					8.2					7.6	45
50	6.5	5.9	5.3				6.8	6.2	5.3	7.2	6.3					8	6.4				7.4	50
55	6.2	5.7	5.2				6.6	5.9	5.2	6.9	6.1	5.3				7.6	6.2				7.2	55
60	5.8	5.5	5				6.4	5.7	5.1	6.7	5.9	5.2				7.3	6.1	5.2			6.9	60
65	5.4	5.3	4.9				6.1	5.5	5	6.5	5.7	5.1				7	5.9	5.1			6	65
70	5	5.2	4.9				5.8	5.4	4.9	6.3	5.5	5				6.7	5.8	5			4.9	70
75	4.7	4.9	4.8				5.4	5.2	4.8	6	5.4	4.9				6	5.6	5			4	75
80	4.4	4.6	4.8				5	5.1	4.8	5.6	5.3	4.9				5.1	5.5	4.9			3.2	80
85	4.2	4.3	4.5				4.2	4.9	4.8	5.1	5.2	4.8				4.6	5.4	4.9			5	85
90	3.9	4					4.2	4.9	4.8	5.1	5.2	4.8				3.8	5	4.9			2.4	90
95							3.6	4.3	4.7	4.4	5	4.8				3.8	4.7	4.8			3.4	95
100							3	3.7	4.1	3.9	4.5	4.8				3.2	4.1	4.8			2.8	100
105							2.5	3		3.4	3.9	4.4				2.6	3.7	4.5			2.8	105
110							2	2.3		3	3.4	3.7				2.3	3	3.6			2.1	110
115										2.5	2.9	3.1				2.6	3.1				2	115
120										2.1	2.4					2.2	2.6				2.4	120
										1.9						1.9					1.9	120

t_262_00212_00_001

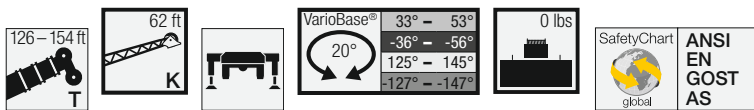

	126 ft 62 ft			140 ft 62 ft			154 ft 62 ft			
	0°	20°	40°	0°	20°	40°	0°	20°	40°	
25	7.9									25
30	8.2									30
35	8.2									35
40	8.2									40
45	8.2									45
50	7.9	6.4								50
55	7.7	6.2								55
60	7.5	6.0								60
65	7.1	6.0	5.1							65
70	6.8	5.7	5.1							70
75	6.6	5.7	4.9							75
80	5.7	5.5	4.9							80
85	5.1	5.3	4.9							85
90	4.4	5.3	4.9							90
95	3.7	4.9	4.9							95
100	3.3	4.2	4.6							100
105	2.6	3.7	4.6							105
110	2.2	3.1	4.0							110
115	1.8	2.6	3.3							115
120	1.3	2.2	2.9							120
125	0.9	1.8	2.4							125
130	0.7	1.3	2.0							130
135		0.9	1.5							135
140		0.7	0.9							140
145			0.7							145
150										150

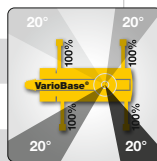

LRT_1090-2.1_Multi_2

Lifting heights Hauteurs de levage

TK

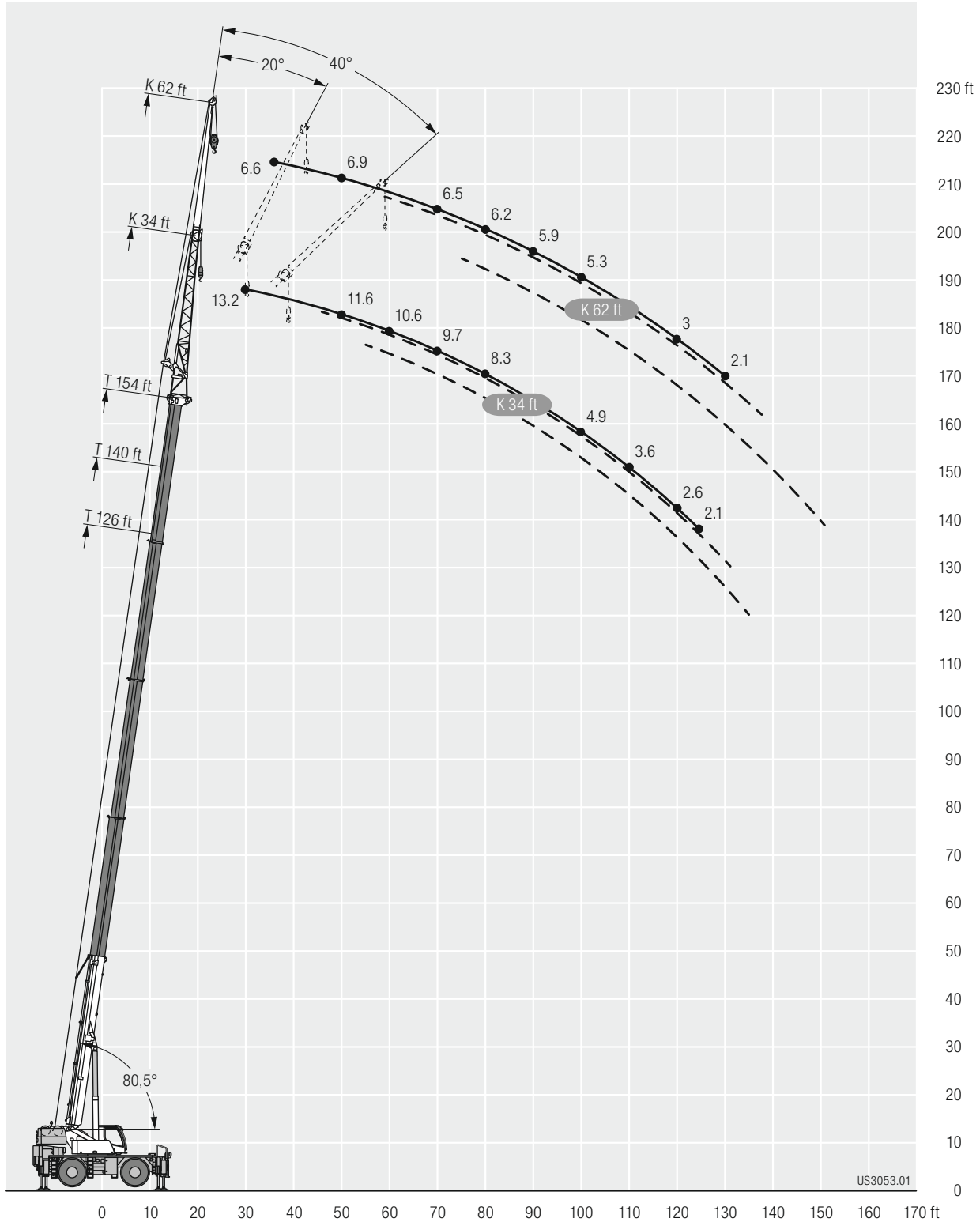

Equipment Equipment

Crane carrier

Frame	Liebherr 2-axle chassis.
Outriggers	4-point supporting system, hydraulically telescopic into horizontal and vertical direction. VarioBase with inclination display and automatic support leveling.
Engine	Diesel, 6 cylinder, watercooled, make Cummins, output 194 kW (264 h.p.), max. torque 730 lbs-ft. Exhaust emissions acc. to EPA/CARB or ECE-R.96. Fuel tank capacity: 93 gallons.
Gearbox	Power shift gearbox with torque converter, integrated 2-stage distribution gearbox with 3 forward and 1 reverse gear.
Axles	Front: planetary axles steerable, driven. Rear: planetary axle with differential lock, steerable, shiftable, oscillating.
Tyres	4 tyres. Tyre size: 29.5 R 25.
Steering	Hydraulic power steering, steering of the rear axle hydraulically shiftable. Special steering programs for various driving situations. Hydrostatic steering of both axles from the crane cab.
Brakes	Operation brake: hydraulic 2 circuit system, all axles equipped with disk brakes. Manual brake: hydraulic locking brake acting on 1. axle. Sustained-action brake: engine brake.
Electrical system	Modern data bus technique, 24 Volt DC, 2 batteries of 110 Ah each.

Crane superstructure

Frame	Liebherr-made, torsion-resistant, welded construction of high-tensile structural steel, single-row ball bearing slewing ring.
Crane drive	4 working motions simultaneously drivable by open oil circuits with electrically controlled „Load Sensing“. By pumps diesel-hydraulically driven.
Control	Electrical control of drives by self-centering joysticks, data transfer with Liebherr System Bus (LSB).
Hoist gear 1 Hoist gear 2	Axial piston fixed displacement motor, hoist drum with integrated planetary gear and spring-loaded static brake, actuation by open regulated oil circuit.
Luffing gear	1 differential hydraulic ram with pilot locking valve.
Slewing gear	Axial piston fixed displacement motor, planetary gear, spring-loaded static brake.
Driver's and crane operator's cab	Spacious corrosion resistant with comfort furnishings, rubber-elastically supported, with safety glazing, Operating and control elements for displacement and crane operation, air-conditioning system, climatized storage compartment. Cabin tiltable approx. 20° to rear.
Safety devices	LICCON2 safe load indicator, test system, hoist limit switch, safety valves to prevent pipe and hose ruptures.
Telescopic boom	1 heel section and 4 telescoping sections. Hydromechanical telescoping system with stage cylinder and two-way pulley tackle. Boom telescopic under part load. Boom length 39 ft – 154 ft.
Counterweight	26,450 lbs
Rooster sheave	Foldable sidewise

Operating modes

K	Double swing-away jib 34 ft – 62 ft Adjustment 0°, 20°, 40°
----------	--

Other items of equipment available on request.

The pictures contain also accessories and special equipment not included in the standard scope of delivery.

Equipment Equipment

Châssis porteur

Cadre	Châssis à 2 essieux Liebherr.
Calage	Dispositif de calage horizontal et vertical en 4 points, entièrement déployable hydrauliquement. VarioBase avec inclinomètre et mise à niveau automatique du calage.
Moteur	Diesel, 6 cylindres, marque Cummins, refroidissement par eau, puissance 194 kW (264 ch), couple maxi. 730 lbs-ft. Emissions des gaz d'échappement conformes aux directives EPA/CARB ou ECE-R.96. Capacité du réservoir carburant: 93 gallons.
Boîte de vitesse	Boîte de vitesses avec convertisseur de couple, mécanisme de distribution à deux étages, avec chacun 3 rapports avant et 1 rapport arrière.
Essieux	Avant : Essieu planétaire, directeur, moteur. Arrière : Essieu planétaire avec blocage de différentiel, directeur, enclenchable, oscillant.
Pneumatiques	4 pneumatiques. Dimension des pneumatiques: 29.5 R 25.
Direction	Servo-direction hydraulique, direction de l'essieu arrière commutable hydrauliquement. Programmes de direction spéciaux pour diverses situations de conduite. Direction hydrostatique des deux essieux depuis la cabine.
Freins	Frein de service : installation hydraulique à 2 circuits, tous les essieux sont équipés de freins à disques. Frein à main : frein de stationnement hydraulique agissant sur le 1er essieu. Frein a regime continu: frein moteur.
Installation électrique	Technique moderne de transmission de données par BUS de données, courant continu 24 Volts, 2 batteries de 110 Ah chacune.

Partie tournante

Cadre	Fabrication Liebherr, construction mécanosoudée en tôle d'acier à haute résistance à grains fins. Couronne d'orientation à 1 rangée de billes.
Entraînement	4 mouvements de travail pouvant être exécutés simultanément via les circuits hydrauliques ouverts avec «Load Sensing» à commande électrique. Entraînement diesel hydraulique par des pompes.
Commande	Commande électrique des mécanismes par leviers de manoeuvre à centrage automatique, Liebherr Système Bus (LSB) pour la transmission.
Mécanisme de levage 1 Mécanisme de levage 2	Moteur hydraulique à cylindrée constante, treuil à réducteur planétaire incorporé et frein d'arrêt à ressort, en circuit hydraulique ouvert ou fermé et régulé.
Mécanisme de relevage	1 vérin différentiel, avec clapet anti-retour de sécurité.
Dispositif de rotation	Moteur à cylindrée constante à pistons axiaux, engrenage planétaire, frein d'arrêt commandé par ressort.
Cabine conducteur / du grutier	Spacieuse cabine, traitement anticorrosion, équipement «grand confort», montée sur silentbloc en caoutchouc et dotée de vitres de sécurité, instruments de commande et de contrôle pour la translation et l'utilisation de la grue, climatisation. Compartiment de rangement climatisé. Cabine inclinable de env. 20° vers l'arrière.

Dispositif de sécurité	Contrôleur de l'état de charge LICCON2, fin de course de levage, soupapes de sécurité sur tubes et flexibles contre rupture.
Flèche télescopique	1 élément de base et 4 éléments télescopiques. Système de télescopage hydromécanique avec vérin à niveaux et poulie moufle double. Flèche télescopable sous charge partielle. Longueur de flèche : 39 ft – 154 ft
Contrepoids	26,450 lbs
Poulie en extrémité de mât	Rabattable sur le côté

Modes de fonctionnement

K	Double fléchette pliante 34 ft – 62 ft Positionnement à 0°, 20°, 40°
----------	---

Autres équipements supplémentaires sur demande.

Les figures contiennent également des accessoires et des équipements spéciaux non inclus de série dans la livraison.

Description of symbols Explication des symboles

General symbols/Symboles généraux



Outriggers
Calage



Outriggers – free on tyres
Calage – libre sur pneus



Vehicle width
Largeur du véhicule



Radius
Portée



Boom length
Longueur de la flèche



Boom position
Position de la flèche



Counterweight
Contrepoids



Tyres
Pneumatiques



Slewing gear / Working area
Mécanisme d'orientation / Plage de travail

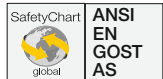

Standard
Norme



Driving speed
Vitesse de translation



Driving speed – Fast gear
Vitesse de translation – Marche rapide



Driving speed – Crawl speed
Vitesse de translation – Marche lente



Max. lifting capacity
Capacité max.



Transmission
Boîte de vitesse



Gear
Vitesse



Hookblock / Capacity
Moufle à crochet / Capacité de charge



Hoist gear
Treuil de levage



Crane carrier
Châssis porteur



Crane superstructure
Partie tournante de la grue



Gradability
Aptitude à gravir les pentes

Crane specific symbols/Symboles spécifiques à la grue



Telescopic boom
Flèche télescopique



Swing away jib
Fléchette pliante



VarioBase

Remarks

1. The load charts are calculated according to ANSI: ASME B30.5, EN 13000, AS 1418.5, GOST.
2. For the calculation of the load charts at least a wind speed of 30 ft/s (9 m/s, 20 mph) and regarding the load a sail area of 1 m² per ton load and a wind resistance coefficient of 1.2 on the load have been taken into account. For lifting of loads with large sail areas and/or high wind resistance coefficients the maximum wind speed as stated in the load charts has to be reduced.
3. Lifting capacities are given in kips.
4. The weight of the hook blocks and hooks is part of the load and therefore it must be deducted from the lifting capacities.
5. Working radii are measured from the slewing centre.
6. The lifting capacities given for the telescopic boom apply if the folding jib is removed.
7. Subject to modification of lifting capacities.
8. Lifting capacities above 154,100 lbs/177,300 lbs only with additional pulley block/special equipment.
9. The data of this brochure serves only for general information. All information is provided without warranty. Instructions for the correct commissioning of the crane please take from the operation manual and the load chart book.

Remarques

1. Les tableaux des charges sont calculés selon ANSI: ASME B30.5, EN 13000, AS 1418.5, GOST.
2. Une vitesse de vent de 30 ft/s (9 m/s, 20 mph) minimum, une surface de prise au vent de 1 m² par tonne ainsi qu'un coefficient de résistance au vent de la charge 1,2 sont pris en compte pour le calcul des tableaux de charge. Lorsque des charges ayant une surface de prise au vent et/ou un coefficient de résistance au vent plus élevé(e)s sont levées, la vitesse de vent maximale indiquée dans les tableaux de charge doit être réduite.
3. Les forces de levage sont données en kips.
4. Le poids du crochet de levage resp. de la moufle à crochet est une partie de la charge et doit donc être déduit de la capacité de charge.
5. Les portées sont calculées à partir de l'axe de rotation.
6. Les charges indiquées pour la flèche télescopique sont valables lorsque la fléchette pliante est démontée.
7. Charges données sous réserve de modification.
8. Forces de levage plus de 154,100 lbs/177,300 lbs seulement avec moufle additionnel/equipement supplémentaire.
9. Les données de cette brochure sont données à titre informatif. Ces renseignements sont sans garantie. Les consignes relatives à la bonne mise en service de la grue sont disponibles dans le manuel d'utilisation et le manuel de tableaux de charge.



Subject to modification / Sous réserve de modifications

Liebherr-Werk Ehingen GmbH

Postfach 1361, 89582 Ehingen, Germany

☎ +49 73 91 5 02-0, Fax +49 73 91 5 02-33 99

www.liebherr.com, E-mail: info.lwe@liebherr.com

www.facebook.com/LiebherrConstruction

Printed in Germany (3) lwe-td-262-01-us03-2018