

Crawler Crane

Complies with ANSI/ASME B 30.5

LR 1250.1

EN-US

LR 1004.03.07/08



LIEBHERR

Concept and characteristics	3
Technical description	6
Dimensions	8
Transport dimensions and weights	9
Self-assembly system	14
Boom combinations	16
Main boom 2320.xx	18
Luffing jib 1713.xx	20
Luffing jib 1916.xx	26
Fixed jib 1008.xx	32
Fixed jib 0806.xx	35
Fixed jib 0906.21	38

Remarks

- The load capacities stated are valid for lifting operation only (corresponding with crane classification according to ISO 4301-1, crane group A1).
- Machine is standing on firm, horizontal ground.
- The weight of the lifting device (pulley block, hoist ropes, shackles etc.) must be deducted from the load capacity.
- Additional equipment on boom (e.g. walkways) must be deducted from the load capacity.
- The max. admissible wind speed can be preselected in the LML software and referred to in the load chart.
- Working radii are measured from centre of swing ring and under load.
- The lifting capacities are valid for 360 degrees of swing.
- Calculation of stability under load is based on ANSI/ASME B 30.5 load ratings as well as ISO 4305 Table 2 and tested according to SAE J765 and SAE J987.
- Weights may vary depending on the delivered configuration of the machine, filling level of the tanks as well as generally valid tolerances.
- The illustrations in this brochure may include options which are not within the standard scope of supply of the machine.

Concept and characteristics

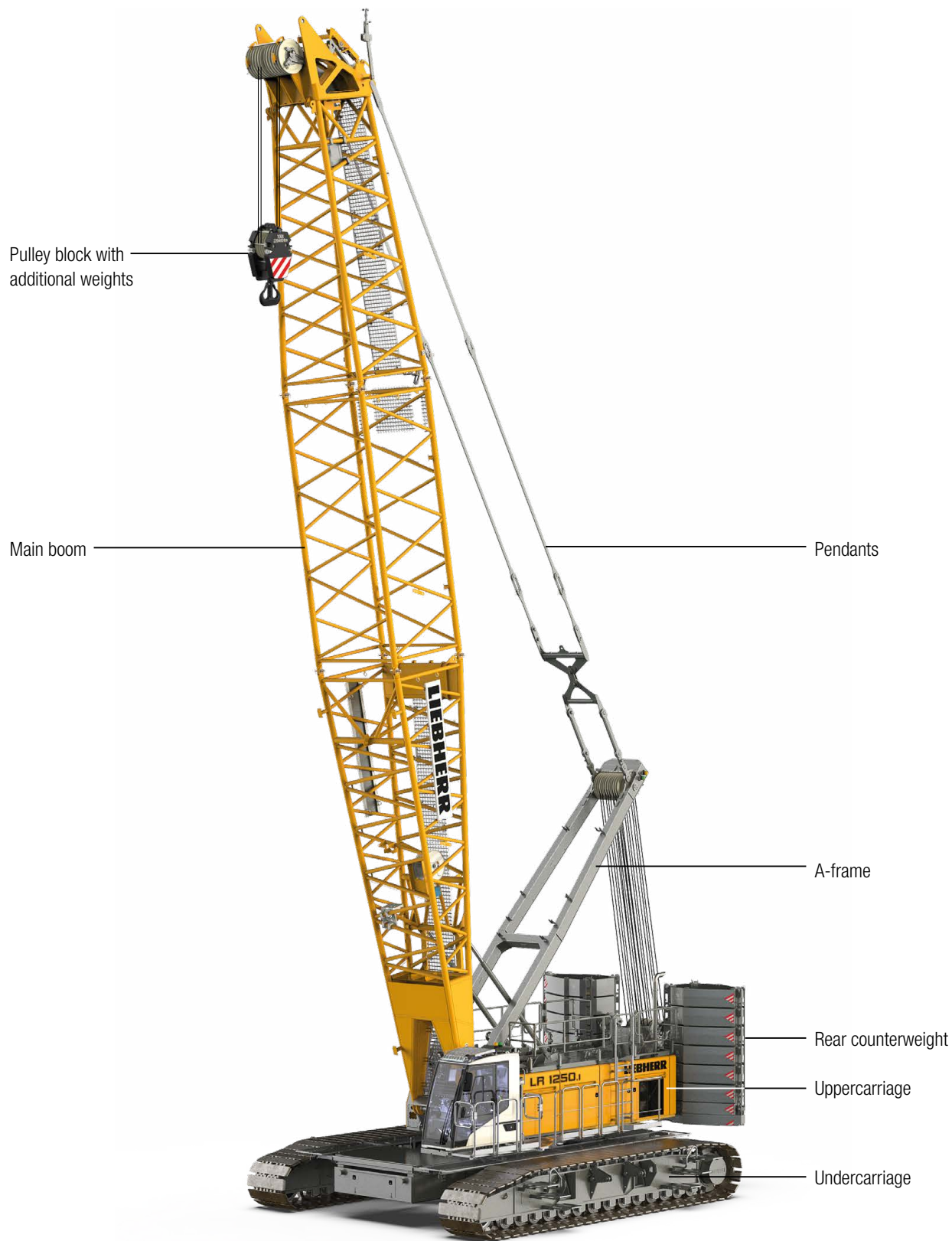

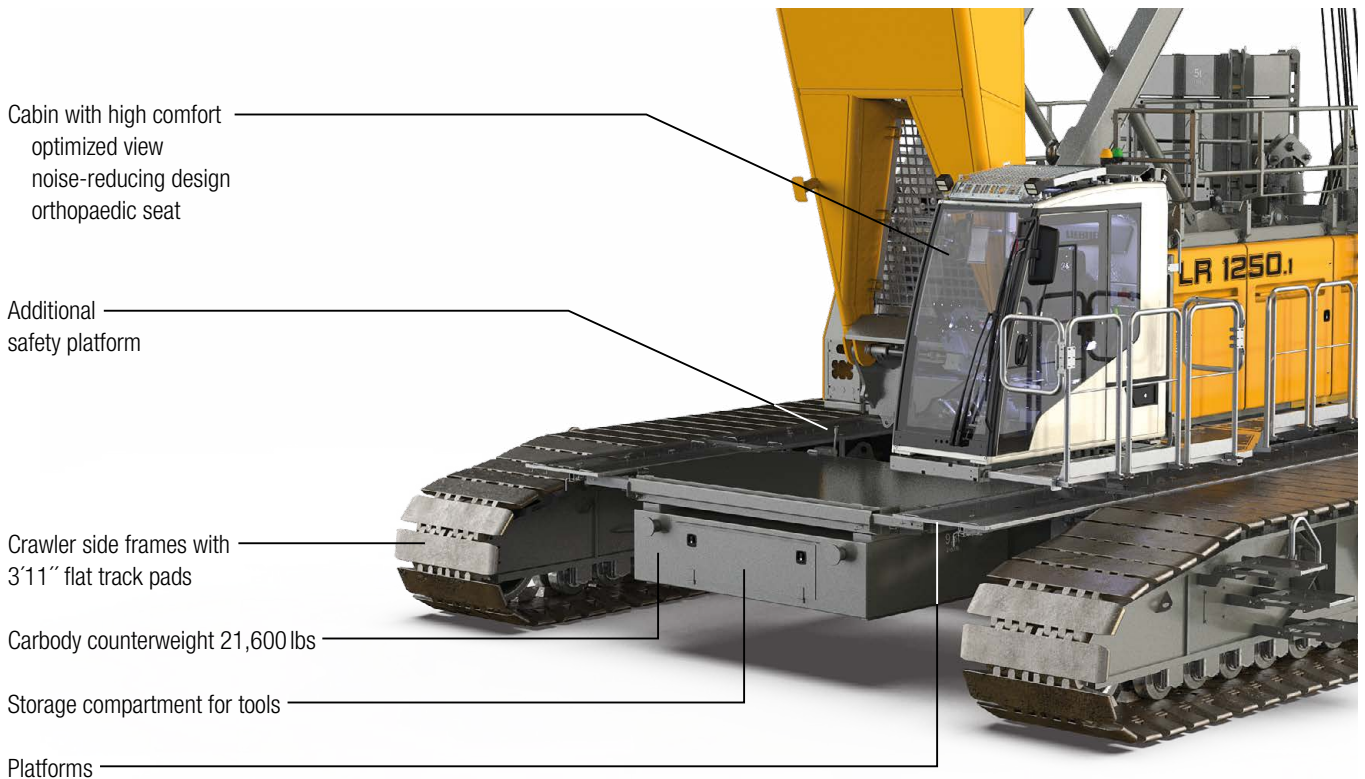

High performance

A strong, efficient and reliable diesel engine of the newest generation provides high performance and enables several movements to be carried out simultaneously.

Ground pressure

The actual ground pressure is calculated according to the configuration and position of the machine and displayed in the operator's cabin. Using the optional Liebherr Crane Planner the actual ground pressure can already be calculated and displayed in the planning stage.

Cabin with high comfort

Optimised field of vision combined with enhanced comfort: an orthopaedic operator's seat with heating and cooling functions, as well as precise and ergonomic controls are included.

Control

Easy and intuitive handling of control, service and machine functions through a large, clear colour monitor. Built for extreme environmental conditions.

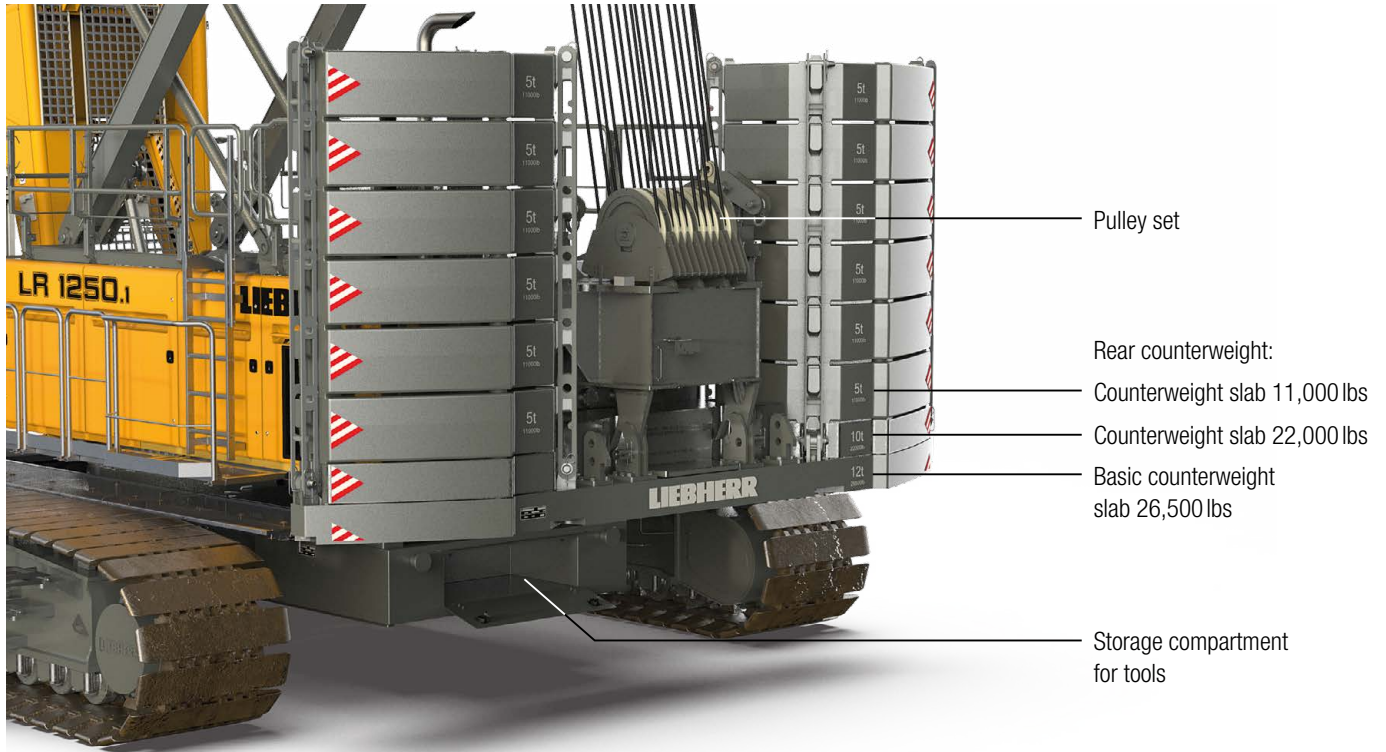

Pulley set

Rear counterweight:

Counterweight slab 11,000 lbs

Counterweight slab 22,000 lbs

Basic counterweight slab 26,500 lbs

Storage compartment for tools

Efficient self-assembly system and short assembly times

The self-assembly system enables safe, independent and quick assembly/disassembly of the crawler side frames, the carbody and rear counterweights, as well as boom elements.

Mobility

Crane parts are optimized for transportation. The maximum transport width is 9.84 ft.

Easy service

The design ensures easy maintenance and service as well as safe access to the components.

Boom/jib

A variety of boom systems and configurations allow for optimum operation on the most diverse jobsites.

Technical description



Diesel engine

Power rating according to ISO 9249	230 kW (308 hp) at 1700 rpm
Engine type	Liebherr D 944 A7-04
Fuel tank capacity	209 gal with continuous level indicator and reserve warning
Exhaust certification	97/68 EC Stage IV; EPA/CARB Tier 4f 97/68 EC Stage V; EPA/CARB Tier 4f ECE-R.96 Power Band H non-certified emission standard



Noise measurement data and vibration

Noise emission	according to 2000/14/EC directive	
Emission sound pressure level L_{PA}	72.9 dB(A)	(in the cabin)
Guaranteed sound power level L_{WA}	107 dB(A)	(of the machine)
Vibration transmitted to the machine operator	< 8.20 ft/s ²	(to the hand-arm system)
	< 1.64 ft/s ²	(to the whole body)



Hydraulic system

Hydraulic pumps	double axial displacement pump in open loop hydraulic system allows all functions to be operated simultaneously automatic working pressure cut-off to minimize peak pressure
Hydraulic oil tank capacity	172 gal
Max. working pressure	5,076 PSI
Hydraulic oil	electronic monitoring of alle filters use of synthetic environmentally friendly oil



Control

Control system	includes all control and monitoring functions, designed to withstand extreme environmental conditions and heavy construction tasks
Display	high resolution monitor in the operator's cabin, clear display of complete machine operating data, warnings and failure indications in the required language
Operation	several movements can be performed simultaneously thanks to electro-hydraulic proportional control, all categories of loads can be positioned with utmost precision



Crawlers

Drive system	with fixed axial piston hydraulic motors
Crawler side frame	maintenance-free, with hydraulic chain tensioning device
Brake	hydraulically released, spring-loaded multi-disc holding brake
Drive speed	0-0.994 mph
Flat track pads	width 3.9 ft



Swing gear

Drive system	with fixed axial piston hydraulic motors, planetary gearbox, pinion
Swing ring	roller bearing with external teeth
Brake	hydraulically released, spring-loaded multi-disc holding brake
Swing speed	0-3 rpm continuously variable
Speed control	both swing modes are possible – speed control or free swing for speed control: a multi-disc holding brake locks automatically at zero swing motion.



Hoisting gear

Standard crane winches 1 + 2	internal low-maintenance planetary gearbox in oil bath, load support by the hydraulic system, spring-loaded, multi-disc holding brake, pressure controlled, variable flow hydraulic motors for the main winches, full utilisation of engine power as the winch speed is automatically adjusted to suit the respective line pull
Line pull in the 7th layer	26,977 lbf
Rope diameter	26 mm
Drum diameter	1.9 ft
Rope speed	0-446 ft/min
Rope capacity in 7 layers	1604 ft
Option – winch with free fall	free fall: clutch and braking functions are provided by the service brake (low wear and maintenance-free multi-disc brake in compact design)







Boom/jib luffing winches

Main boom	
Line pull	max. 40,466 lbf
Rope diameter	24 mm
Boom luffing	15-86° in 130 s
Jib	
Line pull	max. 23,605 lbf
Rope diameter	20 mm
Jib luffing	15-78° in 51 s

Operating weight

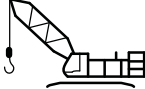
Composition of operating weight	basic machine with crawlers winches 1 + 2 (incl. ropes), A-frame 66 ft main boom, consisting of boom foot (33 ft), boom head (23 ft) and boom section (10 ft) 181,440 lbs rear counterweight (12 × 11,000 lbs + 1 × 26,500 lbs + 1 × 22,000 lbs + 660 lbs) 79,400 lbs carbody counterweight (2 × 21,600 lbs + 2 × 18,300 lbs) 551,200 lbs pulley block
Total weight	approx. 462,971 lbs

Operation modes

	 Lifting mode	 Grab mode	 Personnel lifting mode
 Land	✓	✓	✓
 Floating structure (barge operation)	✓	✓	✓*

* only valid for jack-up barges

Optional equipment

Basic machine

Main winches 26,455lbs with free fall
Painting in customer design
Load hook 27,560/88,100/176,300/220,400/352,700/551,200lbs

Economy and ecology

Eco-Silent Package
Aux. power unit (APU, 2.8 kW)

Boom/jib

Luffing jib: luffing winch
Carbon fibre pendants

Boom/jib other

Walkway for main boom foot, incl. fall protection
Walkway for main boom head, incl. fall protection
Rope guide for main boom walkway, incl. fall protection
Additional fall protection harness for 1 person
Walkways for main boom sections 10/20/40ft
Walkways for main boom sections 10/20/40ft, incl. fall protection

Application packages

Operation mode: personnel lifting (O)
Operation mode: barge operation (O)
Operation mode: foundation work (O)
Operation mode: wind speed pre-selection (S)
Operation mode: travelling with load (S)
Winch synchronization
Radio remote control
Rope reeving function via radio remote control
Assembly radio remote control
Use of luffing jib winch as auxiliary winch
Tagline winch 4,409lbs free fall
Main winch constant tension for one winch
Two hook operation
Cabin elevator 20ft hydraulic

Special features

Crane Planner 2.0
LiDAT

Self-assembly system

Jack-up system standard / telescopic
Self-assembly system counterweight
Self-assembly cylinder
Reeving winch
Track shifting hydraulic

Service package

Refuelling pump diesel / AdBlue
Cold package -25 °C / -40 °C
Hydraulic oil bypass filter
Central lubrication swing ring bearings / outside
Liebherr hydraulic oil plus (longlife & bio)
Liebherr hydraulic oil plus arctic (longlife & bio)
Liebherr hydraulic oil plus arctic (longlife)

Safety features

Assistance system: Boom Up-and-Down Aid
Assistance system: Horizontal Load Path
Assistance system: Vertical Line Finder
Assistance system: Ground Pressure Indication and Visualization
Rear and side view cameras
Winch camera
Zoom camera at boom head
Platforms and railings on uppercarriage 1.9ft
Additional access ladder for boom assembly
Railings on rooftop foldable
Railings for cabin platform
Vandalism cabin protection
Cabin protection roof, FOPS level 1
Lifting height indication for both hoist winches
Plug&Play diesel-hydraulic back-up unit 18.4 kW
Swing and boom radius limit device
Aircraft warning light
Swing warning light
Lightning rod
Mechanical angle display
Air intake shut-off valve
Access control

Operator's comfort

Additional access ladder
Additional floodlights
Cabin air conditioner
Cabin tilting device hydraulic
Gear oil level warning
Litronic additional language

(S) standard, (O) option

Dimensions

Basic machine with undercarriage

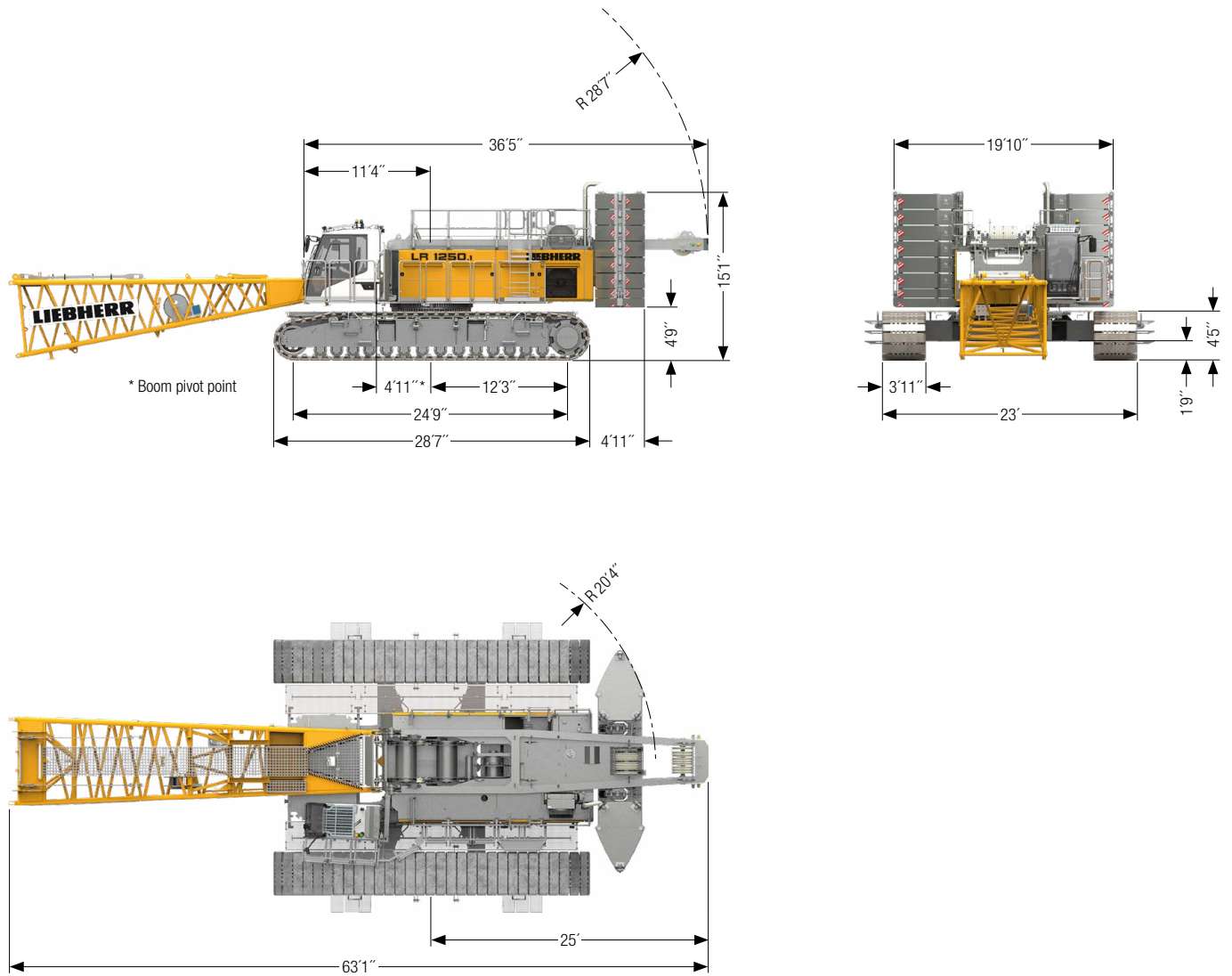

Transport dimensions and weights

Basic machine and main boom 2320.xx

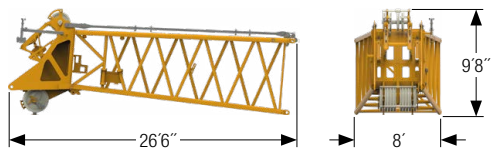
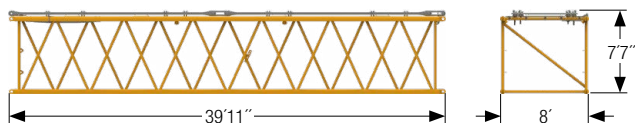
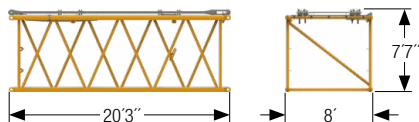
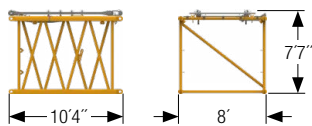
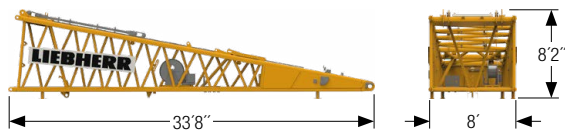
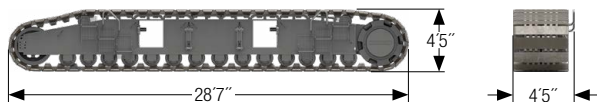
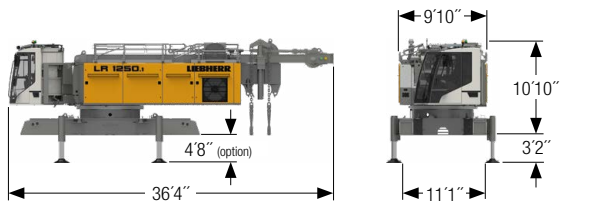

Basic machine

Weight without hoist rope	lbs	82,074
Weight of hoist ropes	lbs/ft	2.28
with A-frame 1, winches 1 + 2 (2x 26,977 lb), without boom foot, without rear counterweight, without carbody counterweight and crawler side frames		

Crawler side frame

Weight flat track pads 3.9ft	lbs	43,338
------------------------------	-----	--------

Boom foot 33 ft (No. 2320.25)

Weight incl. winch	lbs	10,642
Weight without winch	lbs	8,239

Boom section 10 ft (No. 2320.23)

Weight incl. boom pendants	lbs	1,920
Weight incl. boom and jib pendants	lbs	1,894

Boom section 20 ft (No. 2320.23)

Weight incl. boom pendants	lbs	2,963
Weight incl. boom and jib pendants	lbs	3,300

Boom section 40 ft (No. 2320.23)

Weight incl. boom pendants	lbs	5,366
Weight incl. boom and jib pendants	lbs	6,034

Boom head 23 ft (No. 2320.23)

Weight incl. boom pendants	lbs	7,965
----------------------------	-----	-------

Transport option 2320.xx/1916.xx

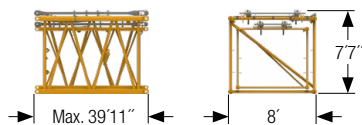

Transport option (No. 2320.xx/1916.xx)

No. 2320.xx/1916.xx	ft	10/10	20/20	40/40
Weight including pendants	lbs	3,202	4,912	8,878

Fixed jib 1008.xx

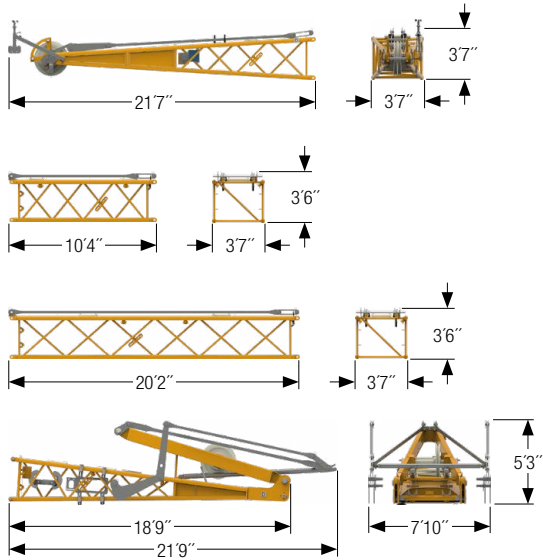

Jib head 18 ft (No. 1008.20)

Weight including pendants	lbs	1,925
---------------------------	-----	-------

Jib section 10 ft (No. 1008.17)

Weight including pendants	lbs	589
---------------------------	-----	-----

Jib section 20 ft (No. 1008.17)

Weight including pendants	lbs	988
---------------------------	-----	-----

Jib foot 18 ft with A-frame (No. 1008.20)

Weight including pendants	lbs	4,652
---------------------------	-----	-------

Fixed jib 0806.xx

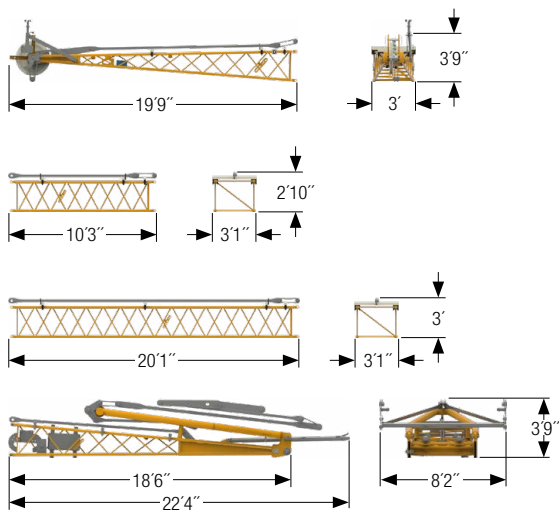

Jib head 18 ft (No. 0806.16)

Weight including pendants	lbs	974
---------------------------	-----	-----

Jib section 10 ft (No. 0806.15)

Weight including pendants	lbs	311
---------------------------	-----	-----

Jib section 20 ft (No. 0806.15)

Weight including pendants	lbs	549
---------------------------	-----	-----

Jib foot 18 ft with A-frame (No. 0806.16)

Weight including pendants	lbs	2,242
---------------------------	-----	-------

Fixed jib 0906.21

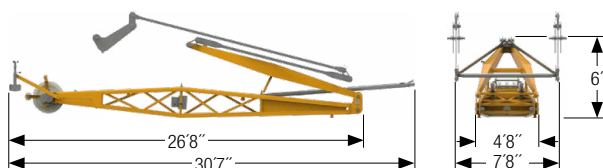

Fixed jib 23 ft (No. 0906.21)

Weight including pendants	lbs	5,320
---------------------------	-----	-------

Luffing jib 1713.xx

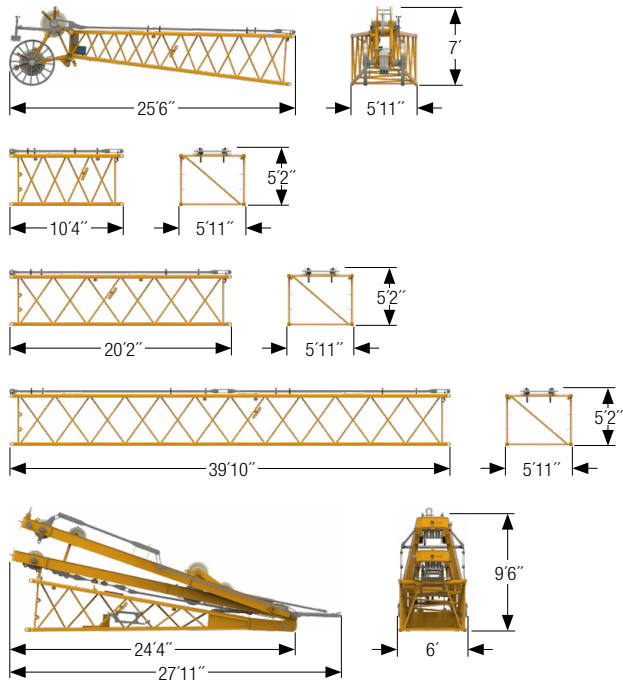

Jib head 23 ft (No. 1713.21)

Weight including pendants	lbs	3,034
---------------------------	-----	-------

Jib section 10 ft (No. 1713.18)

Weight including pendants	lbs	869
---------------------------	-----	-----

Jib section 20 ft (No. 1713.18)

Weight including pendants	lbs	1,376
---------------------------	-----	-------

Jib section 40 ft (No. 1713.18)

Weight including pendants	lbs	2,474
---------------------------	-----	-------

Jib foot 23 ft with A-frames 2 + 3 (No. 1713.22)

Weight including pendants	lbs	10,501
---------------------------	-----	--------

Luffing jib 1916.xx

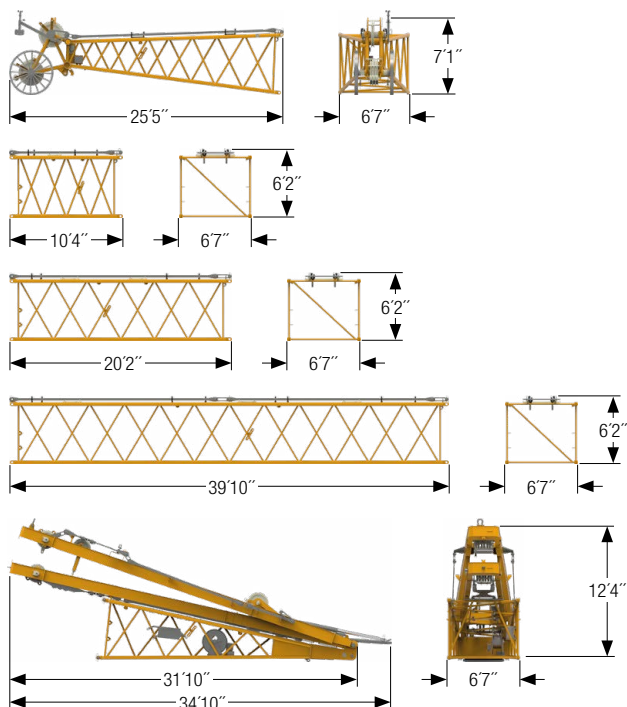

Jib head 23 ft (No. 1916.21)

Weight including pendants	lbs	3,351
---------------------------	-----	-------

Jib section 10 ft (No. 1916.18)

Weight including pendants	lbs	1,089
---------------------------	-----	-------

Jib section 20 ft (No. 1916.18)

Weight including pendants	lbs	1,612
---------------------------	-----	-------

Jib section 40 ft (No. 1916.18)

Weight including pendants	lbs	2,837
---------------------------	-----	-------

Jib foot 23 ft with A-frames 2 + 3 (No. 1916.22)

Weight including pendants	lbs	13,750
---------------------------	-----	--------

Counterweight

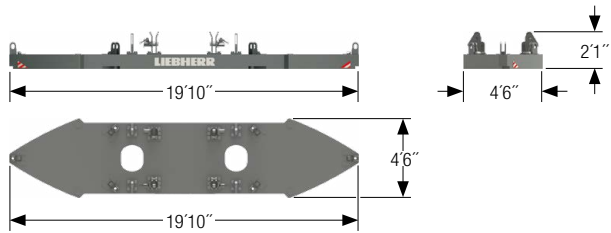

Basic counterweight slab without tie-down (1x)

Weight	lbs	26,500
--------	-----	--------

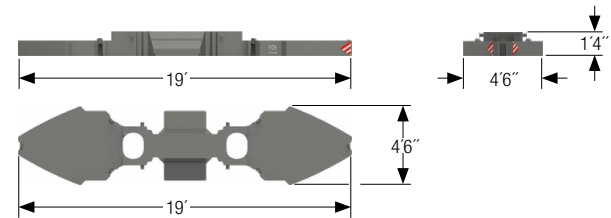

Basic counterweight slab without tie-down (1x)

Weight	lbs	22,000
--------	-----	--------

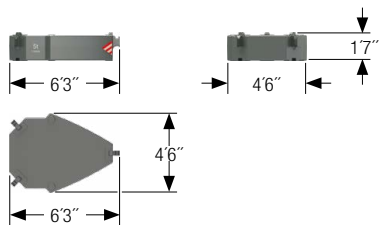

Counterweight slab (12x)

Weight	lbs	11,000
--------	-----	--------

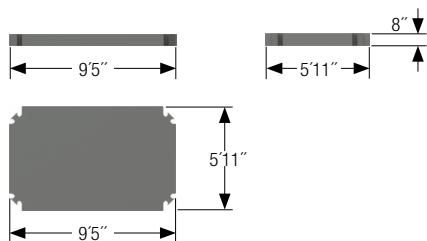

Carbody counterweight slab (2x)

Weight	lbs	18,300
--------	-----	--------

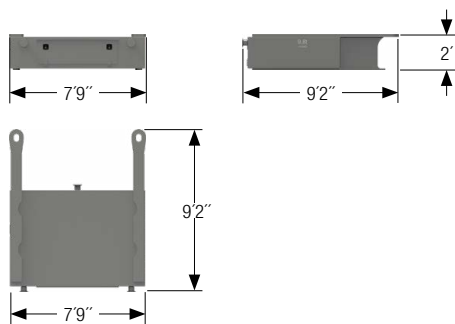

Carbody counterweight (2x)

Weight	lbs	21,600
--------	-----	--------

Pulley block with additional weights / load hooks

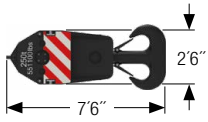

551,200 lbs pulley block – 11 pulleys

Width	4'1"
Weight	lbs 5,070 / 7,055

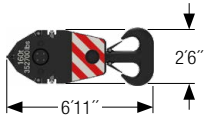

352,700 lbs pulley block – 7 pulleys

Width	2'11"
Weight	lbs 3,307 / 4,960 / 6,614

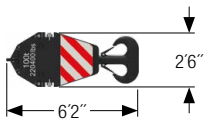

220,400 lbs pulley block – 5 pulleys

Width	2'5"
Weight	lbs 2,866 / 3,968 / 5,071

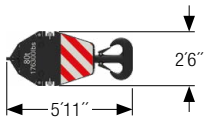

176,300 lbs pulley block – 3 pulleys

Width	1'10"
Weight	lbs 2,205 / 3,307 / 4,409

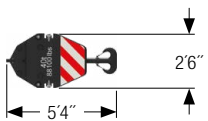

88,100 lbs pulley block – 1 pulley

Width	1'7"
Weight	lbs 1,543 / 2,425 / 3,307

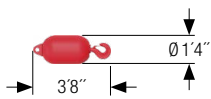

27,560 lbs load hook

Weight	lbs 1,323
--------	-----------

Self-assembly system

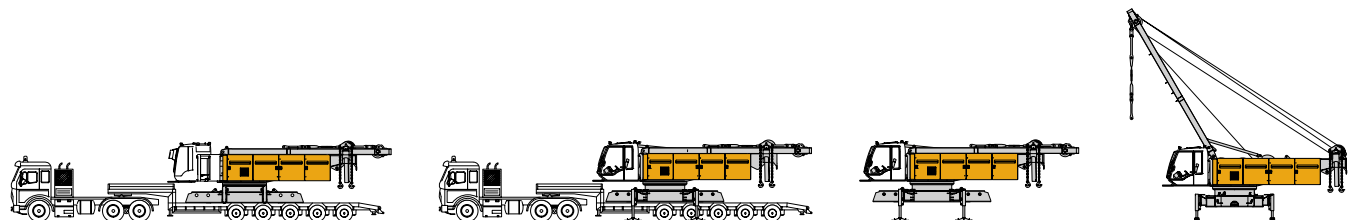

Unloading of basic machine

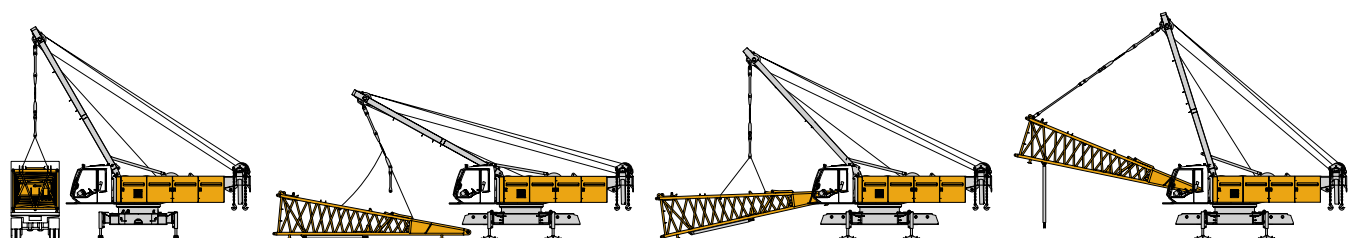

Unloading and assembly of boom foot

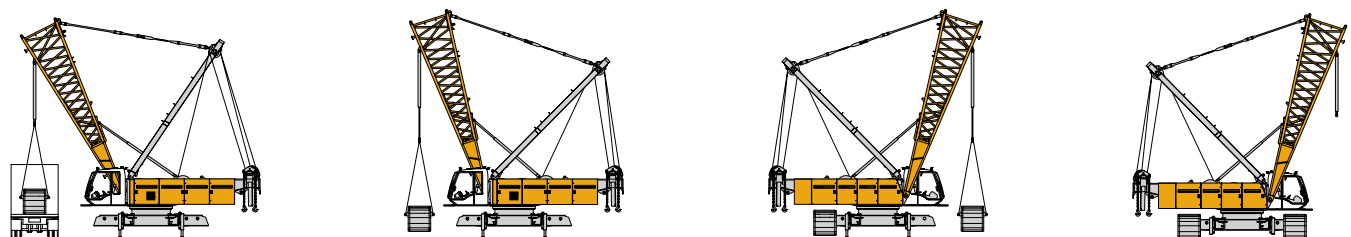

Unloading and assembly of crawler side frames

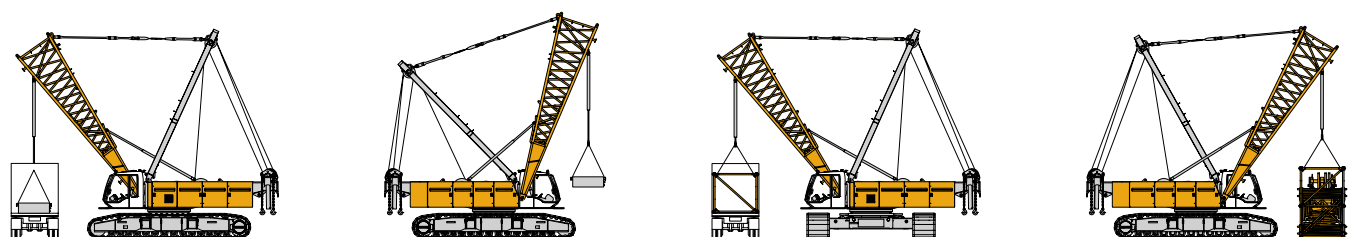

Unloading and assembly of carbody counterweight

Unloading and assembly of boom

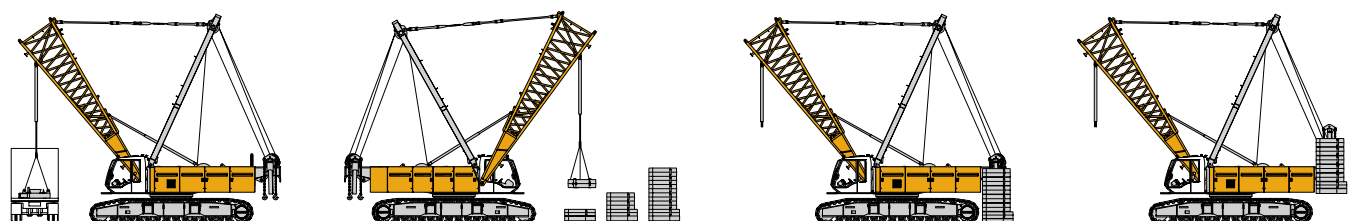

Unloading and assembly of rear counterweight

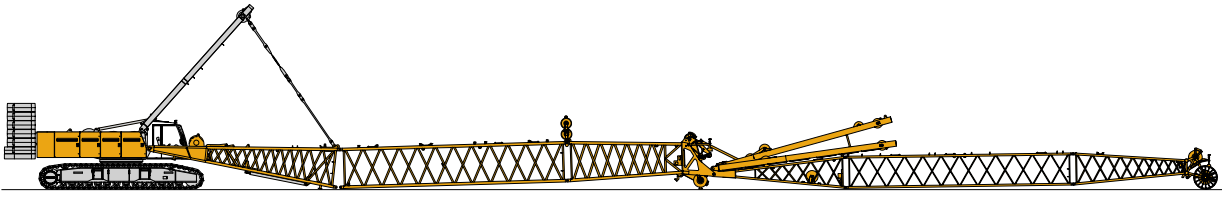

Assembly of boom

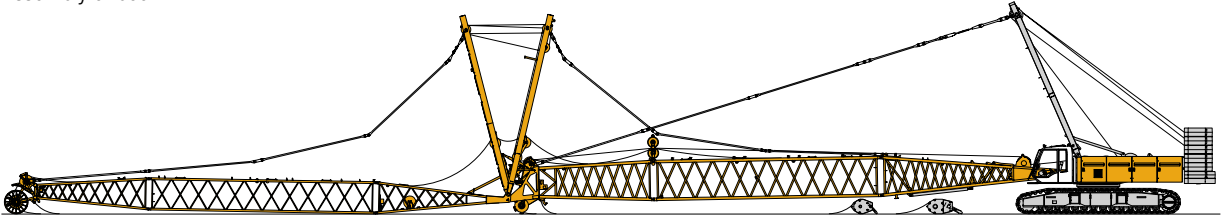

Reeving of hoist and luffing jib ropes

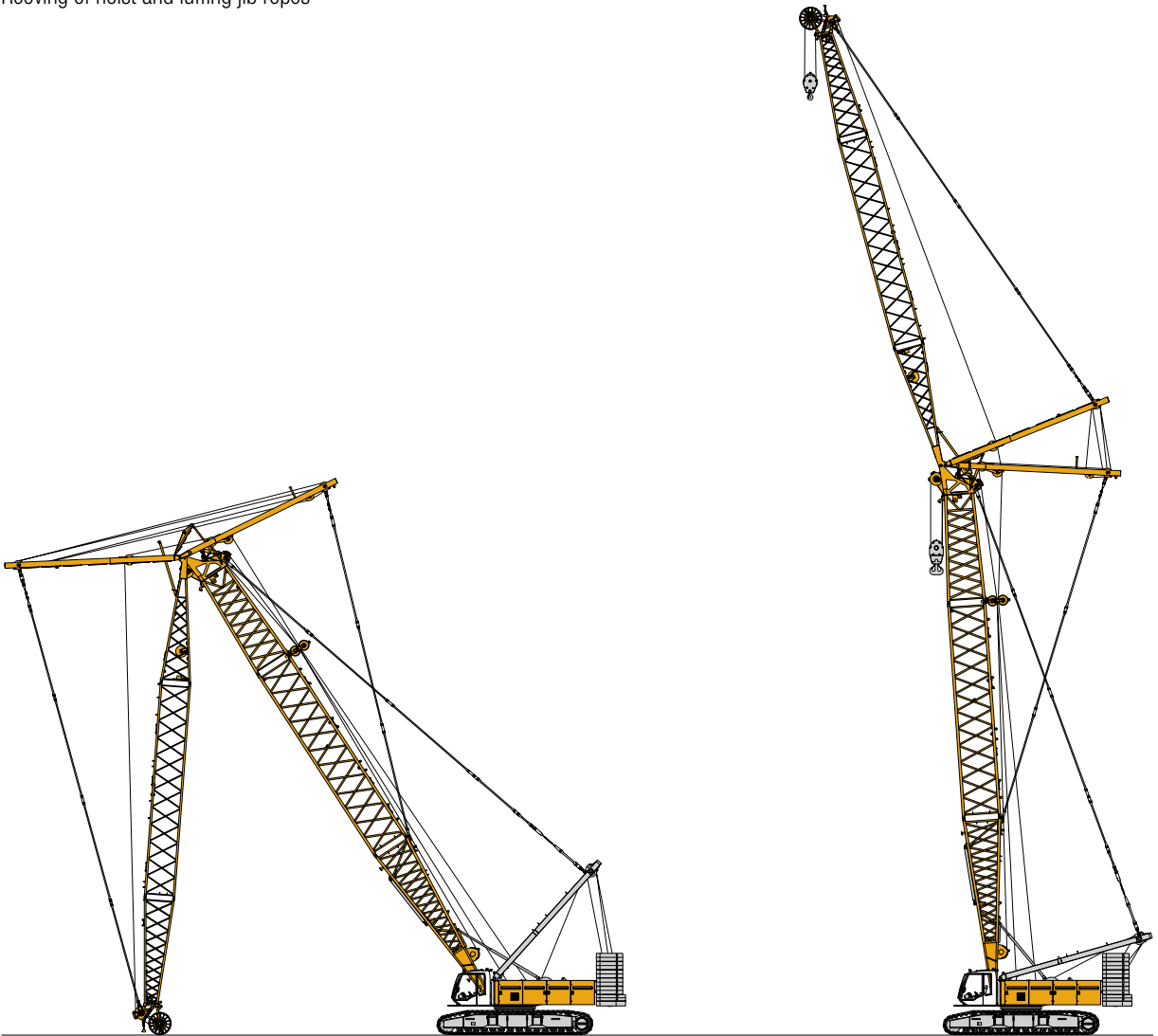

Erecting of main boom and luffing jib

Boom combinations

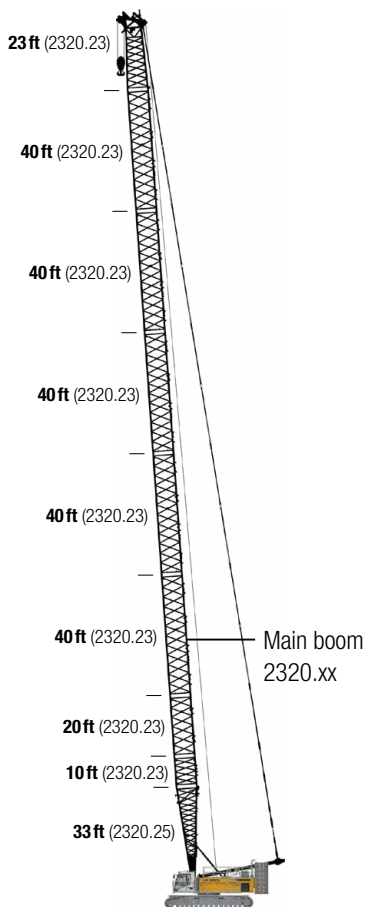

Main boom

Mode 1

Max. length

2320.xx ft 282

Further information on page 18.

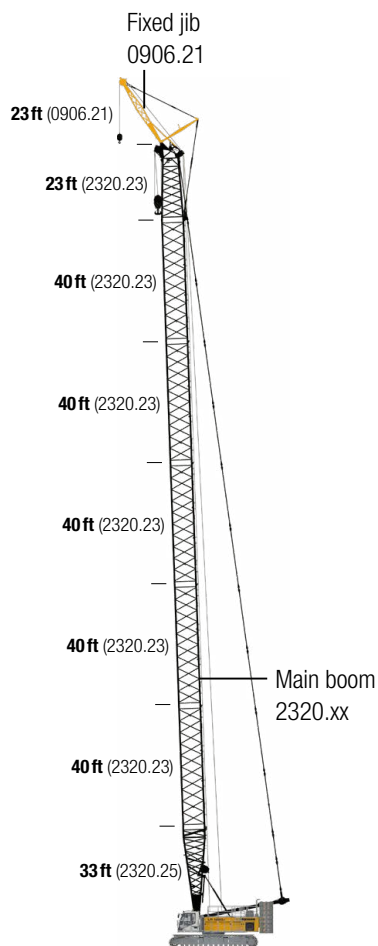

Main boom + fixed jib

Mode 3

Max. combination

2320.xx ft 253

0906.21 ft 23

Total length ft 276

Further information on page 38.

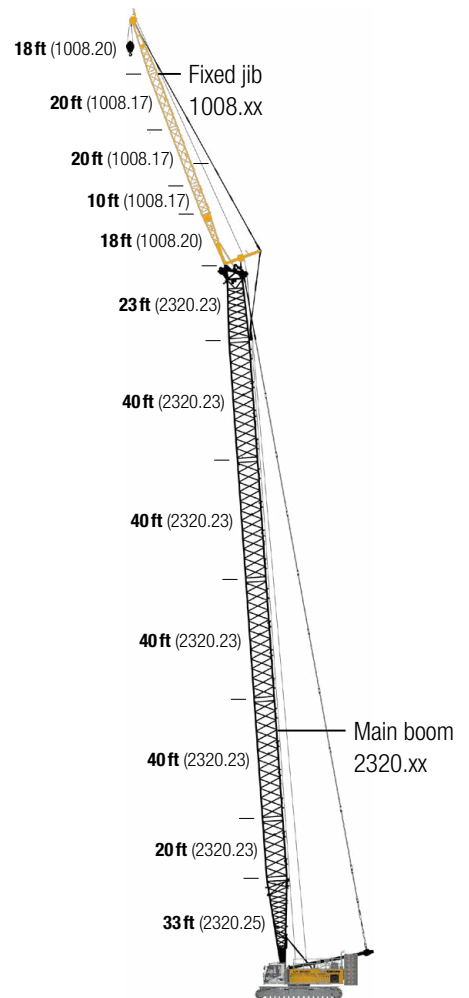

Main boom + fixed jib

Mode 3

Max. combination

2320.xx ft 233 243

1008.xx ft 85 56

Total length ft 318 299

Further information on page 32.

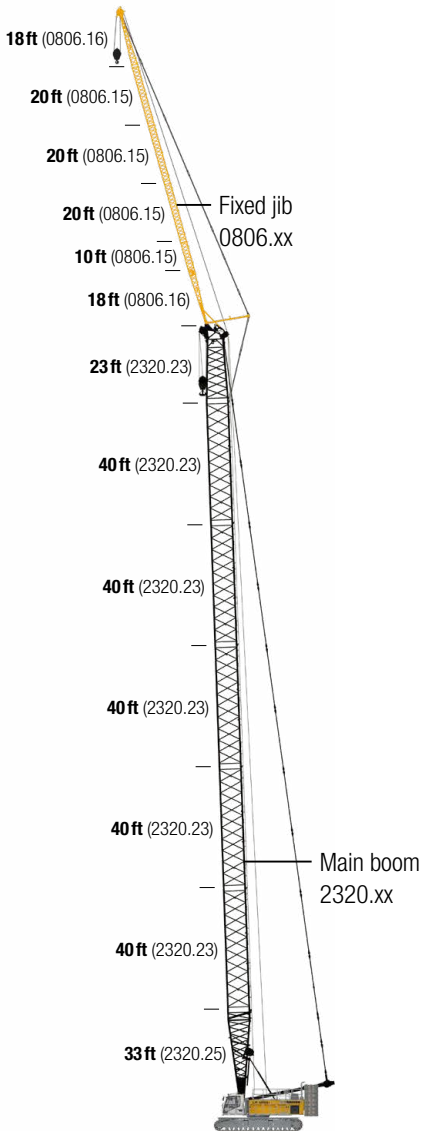

Main boom + fixed jib

Mode 3

Max. combination

2320.xx	ft	253	262
0806.xx	ft	105	76
Total length	ft	358	338

Further information on page 35.

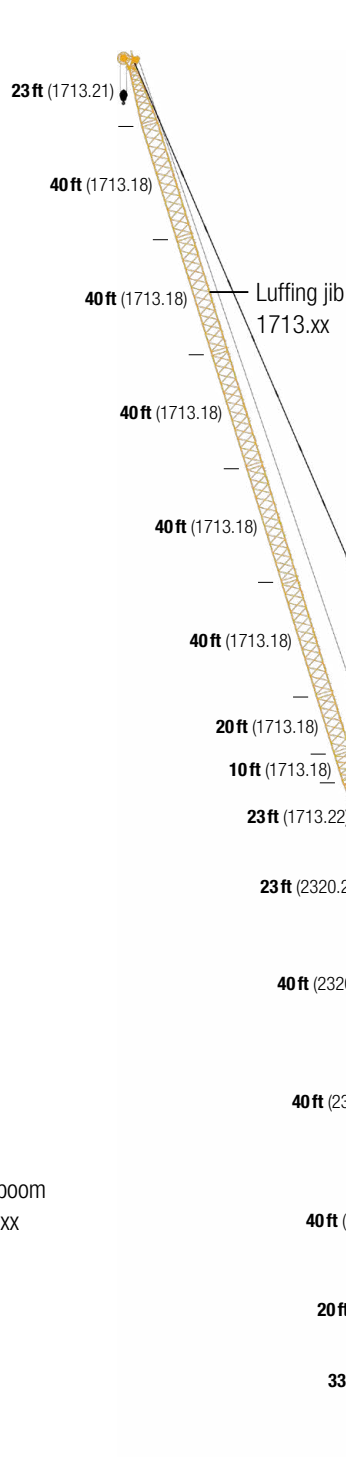

Main boom + luffing jib

Mode 4

Max. combination

2320.xx	ft	194	203	213
1713.xx	ft	272	213	144
Total length	ft	466	416	357

Further information on page 20.

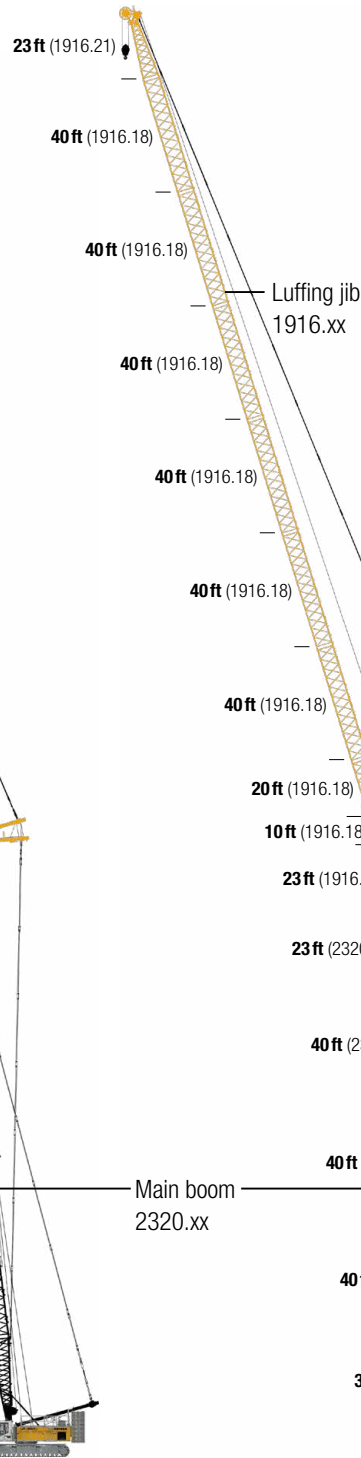

Main boom + luffing jib

Mode 4

Max. combination

2320.xx	ft	174	184	194
1916.xx	ft	312	243	174
Total length	ft	486	427	368

Further information on page 26.

Main boom 2320.xx

Main boom lengths 66-282 ft

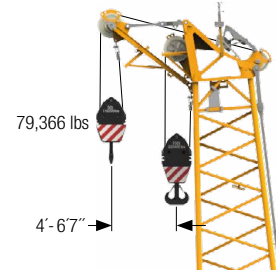
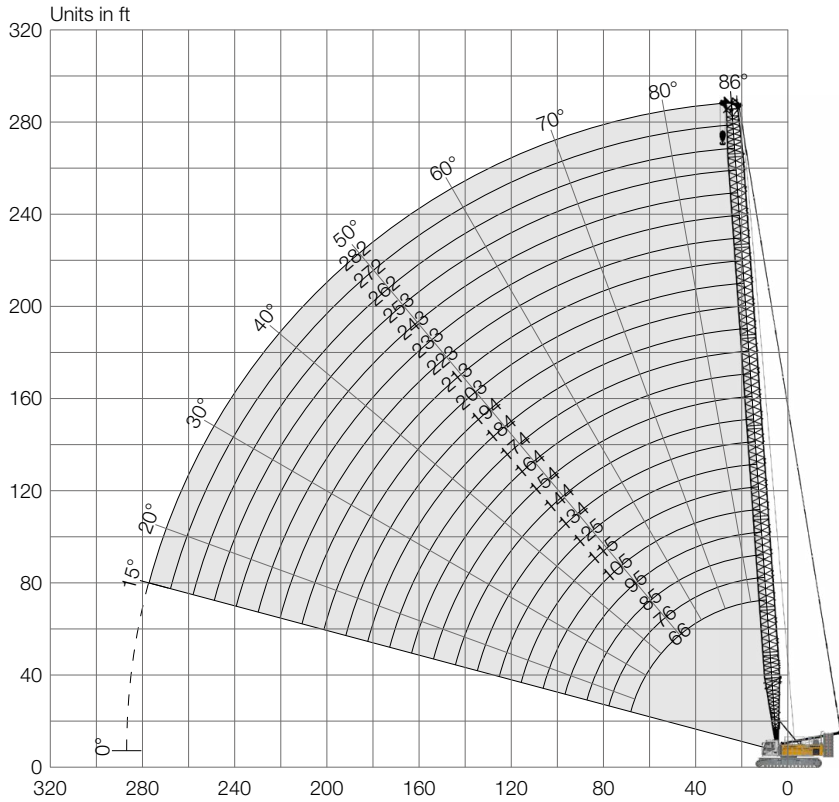

Auxiliary jib 79,366 lbs (option)

The maximum capacity of the auxiliary jib is 79,366 lbs. The corresponding load chart is programmed in the LML system.

Main boom configuration 2320.xx

Boom section	Amount of boom sections												
Boom foot 33 ft	1	1	1	1	1	1	1	1	1	1	1	1	1
Boom section 10 ft	1		1		1		1		1		1		1
Boom section 20 ft		1	1			1	1			1	1		1
Boom section 40 ft				1	1	1	1	2	2	2	2	3	
Boom head 23 ft	1	1	1	1	1	1	1	1	1	1	1	1	1
Boom length [ft]	66	76	85	95	105	115	125	134	144	154	164	174	
Auxiliary jib	✓	✓	✓	✓	✓	✓	✓	✓	✓	✓	✓	✓	✓
Boom foot 33 ft	1	1	1	1	1	1	1	1	1	1	1	1	
Boom section 10 ft	1		1		1		1		1		1		
Boom section 20 ft		1	1			1	1			1	1		
Boom section 40 ft	3	3	3	4	4	4	4	5	5	5	5	5	
Boom head 23 ft	1	1	1	1	1	1	1	1	1	1	1	1	
Boom length [ft]	184	194	203	213	223	233	243	253	262	272	282		
Auxiliary jib	✓	✓	✓	✓	✓	✓	✓	✓	✓	✓	✓	✓	

Load capacities with main boom

Load capacities in 1000 lbs with 181,440 lbs rear counterweight and 79,400 lbs carbody counterweight

Radius [ft]	Boom length [ft]											
	66	85	105	125	144	164	184	203	223	243	262	282
18.9					279.9							
20				318.4	279.9							
30	271.4	271.6	271.6	266.9	248.0	224.2	195.7	170.1	147.0	127.7	111.4	94.4
50	130.5	130.4	130.2	129.8	129.3	128.7	128.2	127.5	127.0	119.4	104.8	90.4
60	102.0	102.1	101.9	101.4	100.9	100.2	99.6	98.9	98.3	97.6	96.9	87.9
70	26.6	83.2	83.0	82.4	81.9	81.2	80.6	79.8	79.2	78.4	77.7	76.9
85		63.9	64.0	63.4	62.9	62.2	61.5	60.7	60.0	59.2	58.5	57.7
95			55.0	54.5	53.9	53.2	52.5	51.7	51.0	50.2	49.4	48.6
105			47.7	47.4	46.9	46.1	45.4	44.6	43.9	43.1	42.3	41.4
115				41.5	41.1	40.4	39.7	38.9	38.1	37.3	36.5	35.6
125				36.6	36.3	35.6	34.9	34.1	33.3	32.5	31.7	30.8
135					32.2	31.6	30.9	30.1	29.3	28.5	27.7	26.8
145					28.7	28.1	27.5	26.7	26.0	25.2	24.4	23.5
155						25.2	24.6	23.8	23.1	22.2	21.4	20.5
165						22.5	22.0	21.2	20.5	19.6	18.8	17.9
180							18.6	17.9	17.1	16.3	15.5	14.6
200								14.2	13.5	12.7	11.9	11.0
220									10.4	9.7	8.9	8.0
240										7.1	6.4	5.6
260											4.3	3.5
275												2.1

Load capacities in 1000 lbs with 159,400 lbs rear counterweight and 79,400 lbs carbody counterweight

Radius [ft]	Boom length [ft]											
	66	85	105	125	144	164	184	203	223	243	262	272
13.4	484.9											
20	416.2	395.0	363.3	318.4	279.9							
30	249.2	249.3	249.4	249.2	248.0	224.2	175.2	170.1	147.0	127.7	111.4	101.9
55	104.8	104.8	104.6	104.1	103.6	103.0	103.2	101.8	101.1	100.5	99.8	95.6
70	26.6	75.7	75.6	75.0	74.5	73.8	74.0	72.4	71.7	71.0	70.3	69.9
85		58.0	58.1	57.5	57.0	56.3	56.4	54.8	54.1	53.3	52.5	52.2
95			49.7	49.2	48.7	48.0	48.2	46.5	45.8	45.0	44.2	43.8
105			43.0	42.7	42.2	41.4	41.6	40.0	39.2	38.4	37.6	37.2
115				37.3	36.8	36.1	36.3	34.6	33.9	33.0	32.3	31.9
125				32.8	32.4	31.7	31.9	30.2	29.5	28.6	27.8	27.4
135					28.7	28.0	28.2	26.6	25.9	25.1	24.3	23.9
145					25.5	24.9	25.2	23.5	22.7	21.9	21.1	20.7
155						22.2	22.5	20.8	20.0	19.2	18.3	17.9
165						19.7	20.0	18.4	17.6	16.8	16.0	15.6
180							16.9	15.3	14.5	13.7	12.9	12.5
190								13.5	12.8	11.9	11.1	10.7
200								11.8	11.1	10.3	9.5	9.1
220									8.3	7.6	6.8	6.4
240										5.2	4.5	4.1
260											2.5	2.1
261												2.0



TLT 11962445. Above load charts are for reference only. For actual lift duty please refer to load chart in operator's cabin or manual. Otherwise we recommend you to plan your lifting job using Crane Planner 2.0.

www.liebherr.com/CranePlanner

Crane Planner 2.0

Luffing jib 1713.xx

Jib lengths 66-272 ft

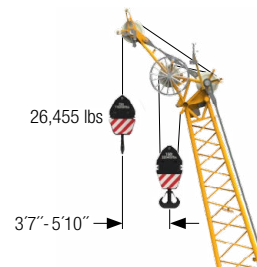
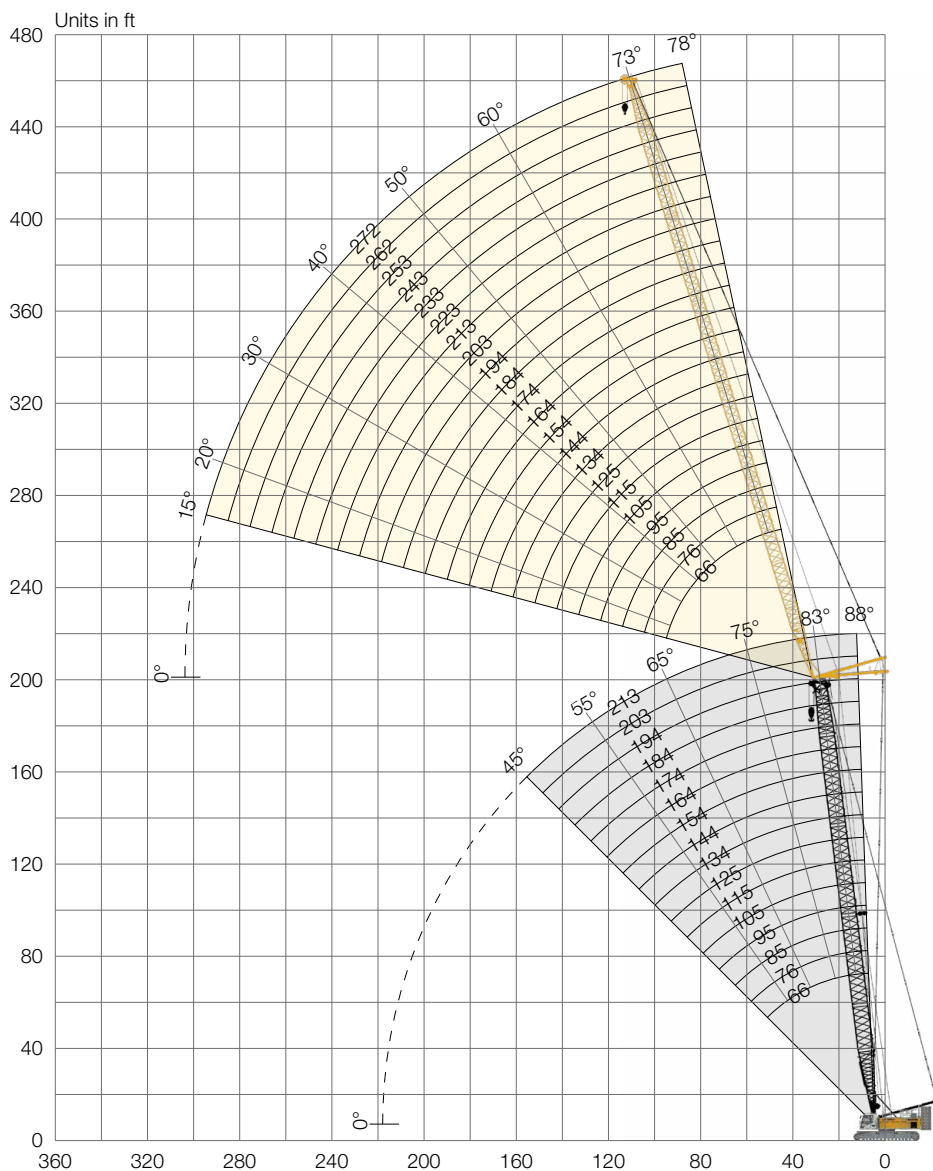

Auxiliary jib 26,455 lbs (option)

The maximum capacity of the auxiliary jib is 26,455 lbs.

Jib configuration 1713.xx

Jib section	Amount of jib sections																						
Jib foot 23 ft	1	1	1	1	1	1	1	1	1	1	1	1	1	1	1	1	1	1	1	1	1		
Jib section 10 ft		1		1		1		1		1		1		1		1		1		1	1		
Jib section 20 ft	1	1			1	1			1	1			1	1			1	1			1		
Jib section 40 ft			1	1	1	1	2	2	2	2	3	3	3	3	4	4	4	4	5	5	5		
Jib head 23 ft	1	1	1	1	1	1	1	1	1	1	1	1	1	1	1	1	1	1	1	1	1		
Jib length [ft]	66	76	85	95	105	115	125	134	144	154	164	174	184	194	203	213	223	233	243	253	262	272	
Auxiliary jib	✓	✓	✓	✓	✓	✓	✓	✓	✓	✓	✓	✓	✓	✓	✓	✓	✓	✓	✓	✓	✓	✓	✓

Actual lengths of boom sections are metric (e.g. 3m, 6m). The figures shown above are approximate conversions to feet. For main boom configuration please refer to the table on page 18.

Load capacities with luffing jib

Load capacities in 1000 lbs with 66 ft main boom 88°

Radius [ft]	Jib length [ft]					
	66	105	144	184	223	272
30	132.3					
40	106.5	102.0				
50	79.6	77.7	72.4			
55	71.9	68.0	64.6	51.5		
60	64.2	60.8	57.5	49.7	34.4	
70	49.5	50.7	48.6	43.6	32.8	19.5
90		36.7	34.8	32.0	29.7	17.7
110		26.7	26.7	26.5	23.6	15.9
150			16.7	16.7	15.0	12.4
185				11.1	10.2	8.1
225					6.1	4.5
260						2.2

181,440 lbs rear counterweight and 79,400 lbs carbody counterweight

Load capacities in 1000 lbs with 95 ft main boom 88°

Radius [ft]	Jib length [ft]					
	66	105	144	184	223	272
26.7	132.3					
40	114.5	105.9				
50	85.2	81.1	72.9			
55	76.7	72.6	68.9	48.8		
60	68.5	64.5	61.0	47.5	32.8	
70	55.5	53.0	51.6	43.9	31.8	18.6
90		39.0	36.9	34.2	28.8	17.1
110		29.8	28.3	26.4	23.8	15.5
150			19.1	17.9	15.9	12.6
190				11.6	10.5	8.5
225					6.8	5.2
270						2.2

181,440 lbs rear counterweight and 79,400 lbs carbody counterweight

Load capacities in 1000 lbs with 134 ft main boom 88°

Radius [ft]	Jib length [ft]					
	66	105	144	184	223	272
28.1	132.3					
40	121.8	99.7				
50	89.5	83.3	67.5			
55	79.1	76.0	66.0	45.3		
65	63.6	60.6	56.5	43.9	30.6	
75	51.6	51.0	48.5	41.6	29.5	17.2
95		37.5	35.3	33.0	27.2	15.9
115		26.6	27.5	25.5	22.9	14.6
150			19.8	17.9	15.8	12.4
190				12.1	10.7	8.5
225					7.2	5.5
275						2.1

181,440 lbs rear counterweight and 79,400 lbs carbody counterweight

Load capacities in 1000 lbs with 164 ft main boom 88°

Radius [ft]	Jib length [ft]					
	66	105	144	184	223	272
29.1	128.0					
40	116.1	86.5				
50	92.4	80.6	58.9			
55	80.4	77.5	57.7	40.7		
65	65.6	61.5	55.1	39.7	28.2	
75	53.5	52.1	48.4	38.3	27.6	15.5
95		38.2	36.0	32.5	25.8	14.7
115		29.1	27.9	25.9	22.6	13.7
150			19.2	17.8	16.0	12.0
190				12.1	10.6	8.6
230					6.8	5.1
275						2.3

181,440 lbs rear counterweight and 79,400 lbs carbody counterweight

Load capacities in 1000 lbs with 213 ft main boom 88°

Radius [ft]	Jib length [ft]					
	66	85	105	125	144	164
30.8	86.6					
40	82.5	72.4	62.6			
50	76.9	68.0	59.8	52.1	45.4	
55	73.9	65.7	58.3	50.9	44.5	38.6
70	61.3	57.9	52.8	44.3	41.8	36.5
80	26.6	49.9	46.7	40.0	37.0	34.4
95		40.1	38.6	37.0	32.7	28.6
105			34.4	33.5	30.8	26.9
115			30.0	29.7	28.5	25.7
135				23.7	22.9	22.0
155					13.2	18.2
175						11.3

181,440 lbs rear counterweight and 79,400 lbs carbody counterweight

TLT 11962445. Above load charts are for reference only. For actual lift duty please refer to load chart in operator's cabin or manual. Otherwise we recommend you to plan your lifting job using Crane Planner 2.0.



www.liebherr.com/CranePlanner

Crane Planner 2.0

Load capacities with luffing jib

Load capacities in 1000 lbs with 66 ft main boom 83°

Radius [ft]	Jib length [ft]					
	66	105	144	184	223	272
37	132.2					
50	94.6	88.1				
65	65.6	61.5	57.6			
75	52.4	51.5	47.1	44.5		
85		43.5	39.7	37.5	30.5	
100		34.9	31.7	29.9	27.9	17.0
115		28.4	26.6	26.6	23.9	15.9
135			22.9	21.0	19.1	14.3
155			18.1	17.0	15.1	12.6
195				10.9	9.8	7.7
230					6.3	4.7
270						2.0

181,440 lbs rear counterweight and 79,400 lbs carbody counterweight

Load capacities in 1000 lbs with 95 ft main boom 83°

Radius [ft]	Jib length [ft]					
	66	105	144	184	223	272
40.6	132.3					
55	94.1	88.6				
65	74.1	69.4	62.4			
80	54.6	52.3	48.8	45.1		
90		44.4	41.4	38.9	29.8	
105		35.9	32.9	31.0	27.7	16.3
120		29.2	27.5	26.6	23.8	15.2
135			25.1	22.4	21.0	14.2
160			18.9	17.3	15.8	12.3
195				12.1	10.9	8.9
235					6.8	5.2
280						2.1

181,440 lbs rear counterweight and 79,400 lbs carbody counterweight

Load capacities in 1000 lbs with 134 ft main boom 83°

Radius [ft]	Jib length [ft]					
	66	105	144	184	223	272
45.4	132.2					
60	94.3	88.4				
70	74.4	69.6	62.0			
80	60.6	56.7	53.2	41.5		
95		44.7	42.2	38.3	27.6	
110		36.2	33.7	31.2	26.2	15.4
125		29.6	28.1	25.9	23.1	14.6
140			25.3	21.8	20.2	13.7
165			19.2	17.3	15.4	12.0
200				12.3	11.1	9.0
240					7.0	5.4
285						2.3

181,440 lbs rear counterweight and 79,400 lbs carbody counterweight

Load capacities in 1000 lbs with 164 ft main boom 83°

Radius [ft]	Jib length [ft]					
	66	105	144	184	223	272
49	123.4					
65	90.4	83.4				
75	72.3	67.1	58.7			
85	59.3	55.2	52.8	39.5		
100		43.3	41.4	37.5	26.7	
110		37.6	35.4	32.9	25.9	14.4
130		29.0	27.7	25.6	22.6	13.7
150			22.5	20.5	18.7	12.6
165			19.6	17.7	15.8	12.0
205				12.3	10.8	8.6
245					6.8	5.3
290						2.3

181,440 lbs rear counterweight and 79,400 lbs carbody counterweight

Load capacities in 1000 lbs with 213 ft main boom 83°

Radius [ft]	Jib length [ft]					
	66	85	105	125	144	164
55	84.7					
65	80.5	71.3				
70	78.1	69.5	61.2			
75	75.5	67.5	59.8	52.0		
80	71.3	64.7	58.2	51.3	44.5	
85	65.3	60.7	56.8	49.9	44.1	38.0
95	54.8	53.2	49.9	46.7	41.8	37.2
115		39.3	38.2	37.3	34.9	32.6
135			29.6	29.3	28.1	26.5
155				23.4	22.8	21.8
175					14.6	18.0
190						15.3

181,440 lbs rear counterweight and 79,400 lbs carbody counterweight

TLT 11962445. Above load charts are for reference only. For actual lift duty please refer to load chart in operator's cabin or manual. Otherwise we recommend you to plan your lifting job using Crane Planner 2.0.



www.liebherr.com/CranePlanner

Crane Planner 2.0

Load capacities with luffing jib

Load capacities in 1000 lbs with 66 ft main boom 75°

Radius [ft]	Jib length [ft]					
	66	105	144	184	223	272
54.6	53.0					
75	64.5	60.1				
90	26.6	46.0	43.1			
105		36.3	34.2	30.7		
125		28.2	26.6	26.2	23.3	
135			24.9	22.9	21.0	
145			22.2	20.6	18.8	14.4
155			20.2	18.4	16.5	13.8
165			18.1	16.4	14.8	12.3
200				11.5	9.8	7.9
240					6.2	4.2
275						2.1

181,440 lbs rear counterweight and 79,400 lbs carbody counterweight

Load capacities in 1000 lbs with 95 ft main boom 75°

Radius [ft]	Jib length [ft]					
	66	105	144	184	223	272
62.2	53.0					
80	71.0	64.7				
100		46.2	42.9			
115		36.8	34.2	31.7		
130		30.6	28.3	26.6	24.2	
140			26.3	24.2	23.0	
150			23.4	21.7	20.3	13.7
160			21.4	19.5	18.1	13.5
170			19.3	17.5	16.2	12.7
210				11.8	10.3	8.5
250					6.6	4.7
295						2.0

181,440 lbs rear counterweight and 79,400 lbs carbody counterweight

Load capacities in 1000 lbs with 134 ft main boom 75°

Radius [ft]	Jib length [ft]					
	66	105	144	184	223	272
72.4	53.0					
90	60.3	59.2				
110		46.5	44.2			
125		37.3	35.2	31.7		
140		31.1	29.1	26.8	23.1	
150			26.6	24.7	22.9	
160			24.5	22.3	20.3	13.0
170			22.3	20.3	18.2	12.9
180			20.1	18.2	16.3	12.4
220				12.3	10.6	8.6
260					6.9	4.9
305						2.1

181,440 lbs rear counterweight and 79,400 lbs carbody counterweight

Load capacities in 1000 lbs with 164 ft main boom 75°

Radius [ft]	Jib length [ft]					
	66	105	144	184	223	272
80.1	53.0					
100	51.0	49.9				
115	26.6	42.1	41.0			
130		36.3	35.2	31.3		
150		30.2	28.3	26.2	22.7	
160			26.6	23.1	21.5	
170			23.9	21.5	18.9	12.2
180			21.8	19.7	16.9	12.1
190			19.7	17.8	15.2	11.6
225				12.8	11.0	8.8
265					7.2	5.2
315						2.1

181,440 lbs rear counterweight and 79,400 lbs carbody counterweight

Load capacities in 1000 lbs with 213 ft main boom 75°

Radius [ft]	Jib length [ft]					
	66	85	105	125	144	164
92.8	51.3					
105	44.3	43.7				
120	37.6	37.2	36.5	36.0		
130		33.7	33.1	32.6	31.9	
135		32.2	31.6	31.1	30.4	29.8
145		29.4	28.9	28.4	27.7	27.2
155			26.6	26.1	25.5	24.9
165			24.5	24.1	23.5	22.9
175				22.3	21.8	21.3
185				18.5	20.2	19.7
200					18.1	17.7
220						15.4

181,440 lbs rear counterweight and 79,400 lbs carbody counterweight

TLT 11962445. Above load charts are for reference only. For actual lift duty please refer to load chart in operator's cabin or manual. Otherwise we recommend you to plan your lifting job using Crane Planner 2.0.



www.liebherr.com/CranePlanner

Crane Planner 2.0

Load capacities with luffing jib

Load capacities in 1000 lbs with 66 ft main boom 65°

Radius [ft]	Jib length [ft]					
	66	105	144	184	223	272
75.1	53.0					
100	49.0	46.2				
125		32.2	29.8			
135		28.7	26.6			
145			25.0	22.1		
170			19.4	17.3	15.3	
175			18.4	16.3	14.7	
195				13.5	11.7	8.7
205				12.3	10.3	8.3
215				11.1	9.2	7.1
250					6.4	4.2
285						2.2

181,440 lbs rear counterweight and 79,400 lbs carbody counterweight

Load capacities in 1000 lbs with 105 ft main boom 65°

Radius [ft]	Jib length [ft]					
	66	105	144	184	223	272
91.7	53.0					
115	43.4	42.4				
140		33.4	32.0			
160			26.6	22.3		
175			23.0	20.7		
185			20.9	18.8	16.2	
200				16.0	14.2	
215				14.1	12.1	9.5
230				12.2	10.2	8.2
250					8.5	6.3
265					7.2	5.0
315						2.1

181,440 lbs rear counterweight and 79,400 lbs carbody counterweight

Load capacities in 1000 lbs with 144 ft main boom 65°

Radius [ft]	Jib length [ft]					
	66	105	144	184	223	272
108.3	42.7					
135		31.6				
155		26.6	25.5			
180			21.0	19.8		
200			18.2	17.1	15.5	
210			16.9	15.9	14.7	
220				14.8	13.7	
230				13.9	12.7	9.5
245				12.5	10.6	8.6
260					9.2	7.1
285					7.1	4.9
330						2.3

181,440 lbs rear counterweight and 79,400 lbs carbody counterweight

Load capacities in 1000 lbs with 184 ft main boom 65°

Radius [ft]	Jib length [ft]					
	66	105	144	184	223	272
125	32.0					
150	25.5	24.4				
175		19.9	18.7			
195			16.1	14.9		
210			14.5	13.3		
220			13.5	12.4	11.1	
235				11.1	9.9	
245				10.4	9.2	6.8
255				9.7	8.5	6.2
265				9.0	7.9	5.7
300					6.0	4.1
350						2.2

181,440 lbs rear counterweight and 79,400 lbs carbody counterweight

Load capacities in 1000 lbs with 213 ft main boom 65°

Radius [ft]	Jib length [ft]					
	66	85	105	125	144	164
137.5	25.4					
150	22.8	22.2				
160	20.9	20.5	19.7			
175		18.2	17.5	16.9		
185			16.2	15.7	15.0	
195			15.1	14.6	13.9	13.2
200			14.5	14.0	13.3	12.8
210				13.1	12.4	11.8
220				12.1	11.5	11.0
235					10.4	9.9
245						9.2
255						8.5

181,440 lbs rear counterweight and 79,400 lbs carbody counterweight

TLT 11962445. Above load charts are for reference only. For actual lift duty please refer to load chart in operator's cabin or manual. Otherwise we recommend you to plan your lifting job using Crane Planner 2.0.



www.liebherr.com/CranePlanner

Crane Planner 2.0

Luffing jib 1916.xx

Jib lengths 66-312 ft

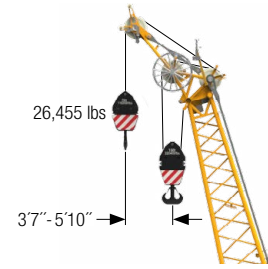
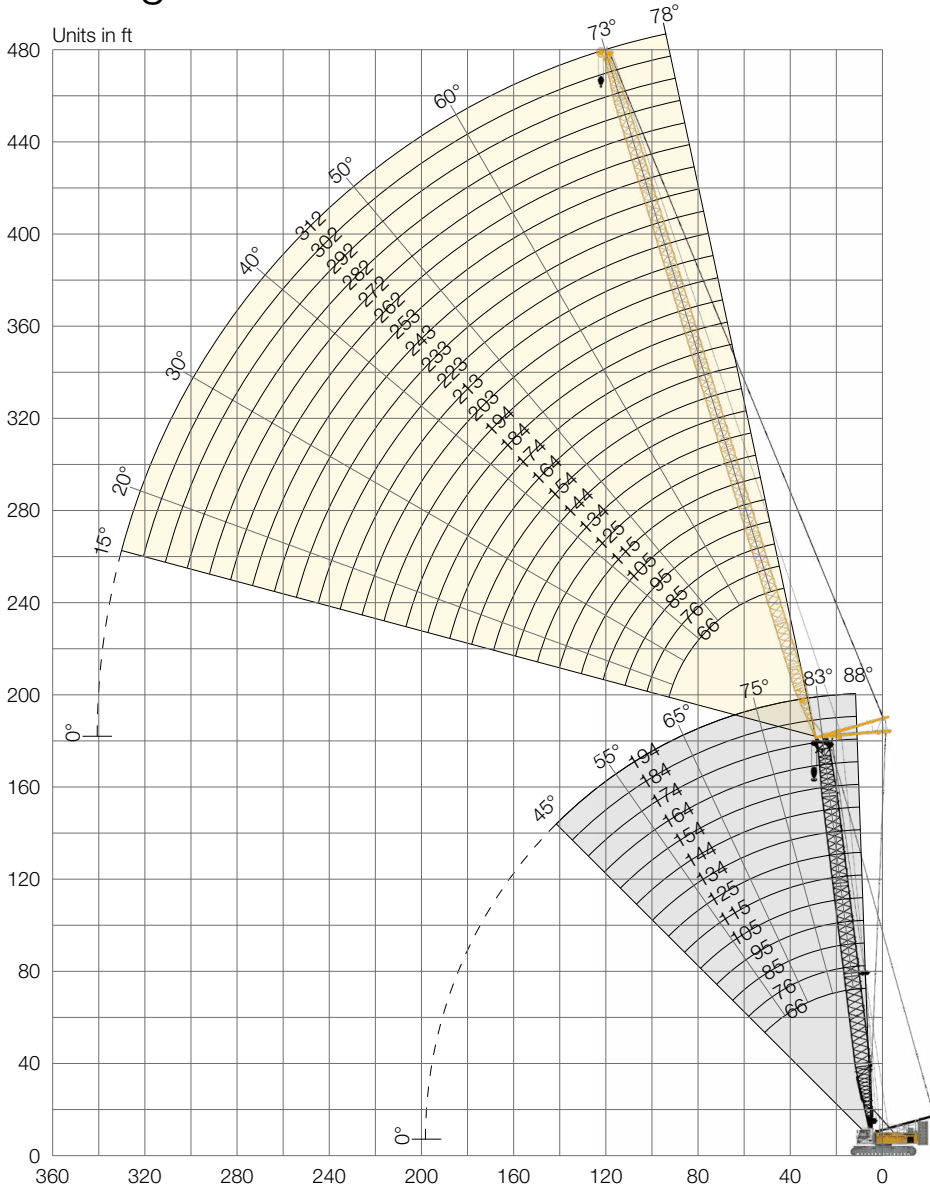

Auxiliary jib 26,455 lbs (option)

The maximum capacity of the auxiliary jib is 26,455 lbs.

Jib configuration 1916.xx

Jib section	Amount of jib sections																									
Jib foot 23 ft	1	1	1	1	1	1	1	1	1	1	1	1	1	1	1	1	1	1	1	1	1	1				
Jib section 10 ft		1		1		1		1		1		1		1		1		1		1		1				
Jib section 20 ft	1	1			1	1		1		1		1		1		1		1		1		1				
Jib section 40 ft			1	1	1	1	2	2	2	3	3	3	3	4	4	4	4	5	5	5	6	6				
Jib head 23 ft	1	1	1	1	1	1	1	1	1	1	1	1	1	1	1	1	1	1	1	1	1	1				
Jib length [ft]	66	76	85	95	105	115	125	134	144	154	164	174	184	194	203	213	223	233	243	253	262	272	282	292	302	312
Auxiliary jib	✓	✓	✓	✓	✓	✓	✓	✓	✓	✓	✓	✓	✓	✓	✓	✓	✓	✓	✓	✓	✓	✓	✓	✓	✓	✓

Actual lengths of boom sections are metric (e.g. 3m, 6m). The figures shown above are approximate conversions to feet. For main boom configuration please refer to the table on page 18.

Load capacities with luffing jib

Load capacities in 1000 lbs with 66 ft main boom 88°

Radius [ft]	Jib length [ft]					
	66	115	164	213	262	312
30	155.8					
40	155.8	123.4				
50	128.4	110.5	79.1			
60	104.4	94.8	75.0	49.4		
70	78.2	81.6	71.6	47.3	30.9	
80		69.4	63.6	45.2	29.4	18.0
100		53.7	51.2	41.8	26.9	16.5
120		37.1	40.6	37.5	24.8	15.1
170			22.5	25.9	21.0	12.1
215				15.1	16.5	10.1
265					8.4	8.0
310						3.6

181,440 lbs rear counterweight and 79,400 lbs carbody counterweight

Load capacities in 1000 lbs with 95 ft main boom 88°

Radius [ft]	Jib length [ft]					
	66	115	164	213	262	312
26.7	155.8					
40	155.8	114.7				
60	111.2	97.8	70.2	44.5		
70	91.8	90.0	67.2	43.5	28.2	
80		77.5	64.4	42.2	27.5	17.4
100		59.1	58.1	39.6	25.5	15.9
120		46.7	46.4	37.2	23.6	14.5
145			36.6	34.5	21.7	12.9
170			28.2	28.7	20.1	11.7
215				19.9	18.2	9.9
265					11.8	7.9
310						5.8

181,440 lbs rear counterweight and 79,400 lbs carbody counterweight

Load capacities in 1000 lbs with 134 ft main boom 88°

Radius [ft]	Jib length [ft]					
	66	115	164	213	262	312
28.1	152.4					
40	147.0	98.9				
50	132.8	94.6	61.8			
60	111.3	89.3	60.3	39.2		
70	91.9	84.6	58.1	38.4	25.7	
80		77.5	55.8	37.4	25.3	15.9
100		59.1	51.4	35.3	23.8	14.9
125		26.6	44.2	32.7	21.9	13.4
170			29.8	28.3	19.2	11.2
220				19.3	17.3	9.2
265					12.5	7.7
315						5.6

181,440 lbs rear counterweight and 79,400 lbs carbody counterweight

Load capacities in 1000 lbs with 164 ft main boom 88°

Radius [ft]	Jib length [ft]					
	66	115	164	213	262	312
29.1	126.0					
40	119.6	81.9				
60	100.3	74.0	51.7	35.1		
75	82.2	67.4	49.0	34.1	23.3	
85		63.1	46.6	33.0	22.8	14.5
100		57.1	43.6	31.5	22.0	13.8
125		44.9	38.7	29.0	20.5	12.5
150			34.2	26.6	19.1	11.3
170			29.7	24.6	18.0	10.5
220				19.3	15.8	8.8
265					12.6	7.2
315						5.4

181,440 lbs rear counterweight and 79,400 lbs carbody counterweight

Load capacities in 1000 lbs with 194 ft main boom 88°

Radius [ft]	Jib length [ft]					
	66	95	115	134	154	174
30.1	101.2					
40	95.8	77.6				
50	88.4	73.4	64.2	56.2	48.6	
55	84.8	70.7	62.5	55.1	47.9	41.7
65	78.7	66.2	58.8	52.6	46.0	40.7
75	74.3	61.8	55.5	49.5	44.0	38.9
90		55.7	50.7	45.5	41.2	36.5
105		51.7	45.8	42.0	37.7	34.3
125			41.7	37.3	34.1	31.2
145				34.3	30.9	28.3
165					26.6	26.0
180						24.7

181,440 lbs rear counterweight and 79,400 lbs carbody counterweight

TLT 11962445. Above load charts are for reference only. For actual lift duty please refer to load chart in operator's cabin or manual. Otherwise we recommend you to plan your lifting job using Crane Planner 2.0.



www.liebherr.com/CranePlanner

Crane Planner 2.0

Load capacities with luffing jib

Load capacities in 1000 lbs with 66 ft main boom 83°

Radius [ft]	Jib length [ft]					
	66	115	164	213	262	312
37	155.8					
55	121.5	113.1				
70	90.0	89.1	73.7			
85		70.3	66.0	45.5		
95		61.4	60.4	43.7	27.8	
110		51.4	50.4	41.3	26.4	15.9
125		40.2	42.8	38.2	24.8	15.0
150			33.9	31.3	22.8	13.5
175			24.7	26.6	21.0	12.2
220				16.6	17.1	10.2
270					9.6	8.1
315						4.6

181,440 lbs rear counterweight and 79,400 lbs carbody counterweight

Load capacities in 1000 lbs with 95 ft main boom 83°

Radius [ft]	Jib length [ft]					
	66	115	164	213	262	312
40.6	155.8					
55	120.4	108.8				
70	89.2	88.2	69.3			
85		69.5	65.8	42.7		
100		57.1	56.0	40.9	26.2	
115		48.1	47.1	38.9	24.9	15.3
130		41.3	40.5	37.2	23.5	14.3
150			33.8	32.5	22.0	13.1
175			27.6	26.5	20.4	11.9
225				18.4	17.3	9.8
270					12.7	8.2
320						6.3

181,440 lbs rear counterweight and 79,400 lbs carbody counterweight

Load capacities in 1000 lbs with 134 ft main boom 83°

Radius [ft]	Jib length [ft]					
	66	115	164	213	262	312
45.4	151.5					
60	106.2	96.8				
75	80.7	79.5	61.9			
90		63.7	59.7	38.8		
105		52.8	51.7	37.6	24.4	
120		44.8	43.8	36.0	23.3	14.1
135		38.7	37.8	34.5	22.1	13.4
150			33.0	31.7	21.2	12.6
180			26.0	24.8	19.4	11.3
230				17.3	16.2	9.4
275					11.8	7.9
325						6.4

181,440 lbs rear counterweight and 79,400 lbs carbody counterweight

Load capacities in 1000 lbs with 164 ft main boom 83°

Radius [ft]	Jib length [ft]					
	66	115	164	213	262	312
49	123.1					
65	94.7	81.2				
80	73.5	72.3	52.8			
95		58.6	50.7	34.7		
110		49.0	47.9	33.7	22.4	
125		41.9	40.8	32.4	21.6	13.1
140		26.6	35.4	31.0	20.6	12.4
160			29.8	28.4	19.6	11.5
185			24.6	23.3	18.3	10.5
235				16.3	15.2	8.8
280					11.1	7.4
330						5.7

181,440 lbs rear counterweight and 79,400 lbs carbody counterweight

Load capacities in 1000 lbs with 194 ft main boom 83°

Radius [ft]	Jib length [ft]					
	66	95	115	134	154	174
52.6	99.1					
65	92.7	76.7				
70	84.9	74.5	65.4			
75	78.1	72.3	64.0	56.1		
80	72.2	70.5	62.4	55.2	47.9	
85	67.0	66.4	60.8	54.2	47.5	41.3
95	58.5	58.0	57.4	51.7	45.8	40.4
125		26.6	41.1	40.6	40.1	36.1
140			35.6	35.3	34.7	34.0
160				29.7	29.2	28.8
180					25.0	24.6
200						21.3

181,440 lbs rear counterweight and 79,400 lbs carbody counterweight

TLT 11962445. Above load charts are for reference only. For actual lift duty please refer to load chart in operator's cabin or manual. Otherwise we recommend you to plan your lifting job using Crane Planner 2.0.



www.liebherr.com/CranePlanner

Crane Planner 2.0

Load capacities with luffing jib

Load capacities in 1000 lbs with 66 ft main boom 75°

Radius [ft]	Jib length [ft]					
	66	115	164	213	262	312
54.6	53.0					
80	74.1	73.0				
100		55.6	54.5			
120		44.5	43.5	40.8		
140			35.8	34.4	23.9	
160			30.2	28.8	22.5	13.1
185			24.9	23.7	20.8	12.0
205				20.4	19.1	11.1
230				17.2	16.0	10.1
255					13.4	9.0
280					11.3	8.2
325						5.9

181,440 lbs rear counterweight and 79,400 lbs carbody counterweight

Load capacities in 1000 lbs with 95 ft main boom 75°

Radius [ft]	Jib length [ft]					
	66	115	164	213	262	312
62.2	53.0					
85	67.1	65.7				
105		50.8	49.6			
125		41.0	39.9	38.4		
150			31.6	30.2	22.6	
160			29.1	27.7	22.0	
170			26.8	25.5	21.3	12.4
180			24.9	23.6	20.7	11.9
190			23.1	21.8	20.1	11.4
240				15.3	14.1	9.6
285					10.3	8.2
335						5.9

181,440 lbs rear counterweight and 79,400 lbs carbody counterweight

Load capacities in 1000 lbs with 134 ft main boom 75°

Radius [ft]	Jib length [ft]					
	66	115	164	213	262	312
72.4	53.0					
95	55.9	54.5				
115		43.1	41.8			
135		35.3	34.1	32.5		
160			27.3	25.9	21.2	
170			25.3	23.8	20.7	
180			23.4	21.9	20.1	11.7
190			21.7	20.3	18.9	11.4
200			20.2	18.8	17.4	10.9
250				13.2	11.9	9.3
295					8.6	7.2
345						4.5

181,440 lbs rear counterweight and 79,400 lbs carbody counterweight

Load capacities in 1000 lbs with 164 ft main boom 75°

Radius [ft]	Jib length [ft]					
	66	115	164	213	262	312
80	53.0					
105	47.4	45.9				
125		37.0	35.6			
145		30.7	29.4	27.7		
165			24.8	23.2	19.7	
175			22.9	21.4	19.5	
185			21.2	19.7	18.2	10.8
200			19.0	17.5	16.1	10.5
210			17.7	16.3	14.9	10.1
255				11.8	10.5	8.4
305					7.1	5.4
350						3.5

181,440 lbs rear counterweight and 79,400 lbs carbody counterweight

Load capacities in 1000 lbs with 194 ft main boom 75°

Radius [ft]	Jib length [ft]					
	66	95	115	134	154	174
87.7	53.0					
105	45.1	44.1				
110	42.6	41.6	40.9			
120	38.2	37.4	36.7	36.1		
130		33.9	33.2	32.6	31.9	
135		32.3	31.7	31.1	30.4	29.8
150		28.2	27.7	27.2	26.5	25.9
160			25.5	25.0	24.3	23.8
170			23.5	23.0	22.4	21.9
185				20.5	19.9	19.4
205					17.2	16.7
225						14.5

181,440 lbs rear counterweight and 79,400 lbs carbody counterweight

TLT 11962445. Above load charts are for reference only. For actual lift duty please refer to load chart in operator's cabin or manual. Otherwise we recommend you to plan your lifting job using Crane Planner 2.0.



www.liebherr.com/CranePlanner

Crane Planner 2.0

Load capacities with luffing jib

Load capacities in 1000 lbs with 66 ft main boom 65°

Radius [ft]	Jib length [ft]					
	66	115	164	213	262	312
75	53.0					
105		50.1				
135		36.7	35.6			
160			28.6	27.1		
175			25.4	24.0		
190			22.7	21.4	20.0	
205				19.1	17.8	
220				17.2	15.9	10.7
230				16.0	14.8	10.3
240				15.0	13.7	9.9
290					9.6	8.2
335						5.6

181,440 lbs rear counterweight and 79,400 lbs carbody counterweight

Load capacities in 1000 lbs with 95 ft main boom 65°

Radius [ft]	Jib length [ft]					
	66	115	164	213	262	312
87.5	53.0					
120		40.1				
145		31.6	30.4			
175			23.7	22.2		
190			21.2	19.7		
205			19.0	17.6	16.2	
220				15.8	14.4	
230				14.7	13.3	10.2
245				13.2	11.9	9.8
255				12.3	11.0	9.4
300					7.9	6.5
350						3.9

181,440 lbs rear counterweight and 79,400 lbs carbody counterweight

Load capacities in 1000 lbs with 134 ft main boom 65°

Radius [ft]	Jib length [ft]					
	66	115	164	213	262	312
104.1	45.0					
135		31.2				
165		24.1	22.7			
190			18.7	17.0		
205			16.7	15.1		
220			15.0	13.5	12.0	
235				12.1	10.6	
250				10.8	9.4	7.2
265				9.7	8.3	6.2
290					6.7	4.8
320					5.1	3.4
355						2.0

181,440 lbs rear counterweight and 79,400 lbs carbody counterweight

Load capacities in 1000 lbs with 164 ft main boom 65°

Radius [ft]	Jib length [ft]					
	66	115	164	213	262	312
116.6	35.9					
145		25.6				
175		20.0	18.6			
205			14.7	13.0		
220			13.2	11.5		
230			12.2	10.6	8.6	
250				9.1	7.2	
260				8.4	6.6	4.0
275				7.5	5.7	3.2
285				6.9	5.2	2.7
300					4.5	2.0
330					3.3	

181,440 lbs rear counterweight and 79,400 lbs carbody counterweight

Load capacities in 1000 lbs with 194 ft main boom 65°

Radius [ft]	Jib length [ft]					
	66	95	115	134	154	174
129.1	28.4					
150	23.4	22.4				
160		20.6	19.8			
170		19.0	18.3	17.6		
180		17.5	16.8	16.2	15.4	
195			15.0	14.4	13.7	13.1
200			14.4	13.9	13.2	12.6
210				12.9	12.2	11.6
220				11.9	11.3	10.7
230					10.5	9.9
240					9.7	9.2
255						8.1

181,440 lbs rear counterweight and 79,400 lbs carbody counterweight

TLT 11962445. Above load charts are for reference only. For actual lift duty please refer to load chart in operator's cabin or manual. Otherwise we recommend you to plan your lifting job using Crane Planner 2.0.



www.liebherr.com/CranePlanner

Crane Planner 2.0

Fixed jib 1008.xx

Jib lengths 36-85 ft

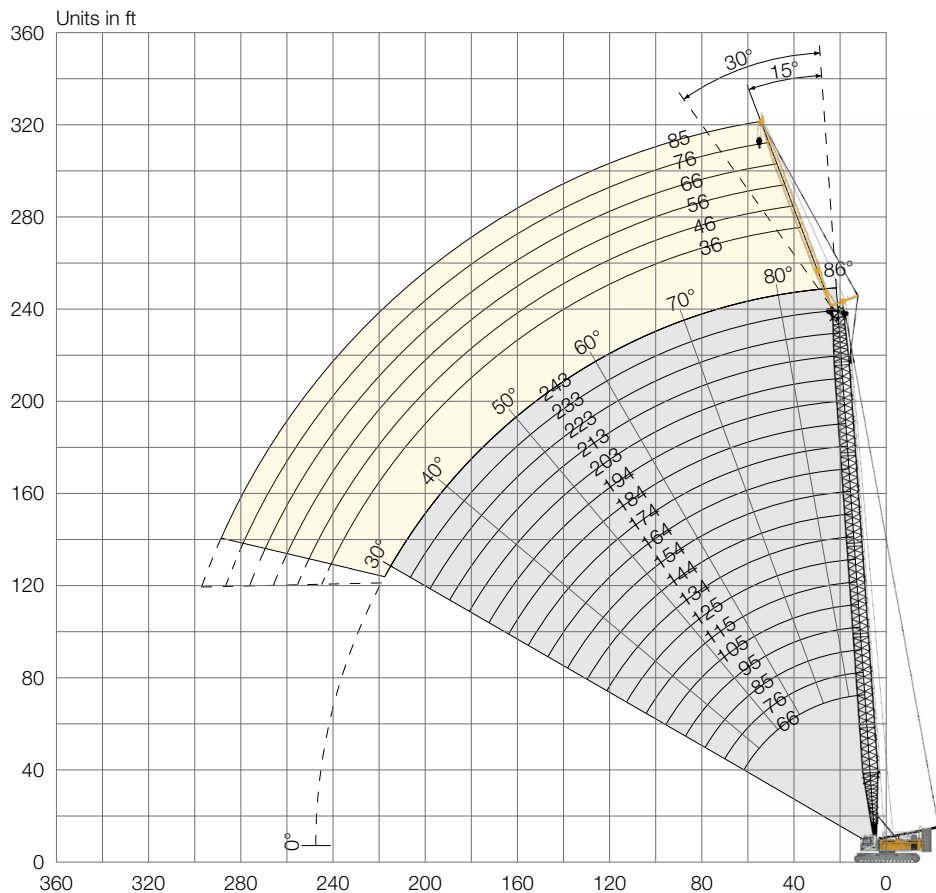

Jib configuration 1008.xx

Jib section	Amount of jib sections					
Jib foot 18 ft	1	1	1	1	1	1
Jib section 10 ft		1		1		1
Jib section 20 ft			1	1	2	2
Jib head 18 ft	1	1	1	1	1	1
Jib length [ft]	36	46	56	66	76	85

Actual lengths of boom sections are metric (e.g. 3 m, 6 m). The figures shown above are approximate conversions to feet. For main boom configuration please refer to the table on page 18.

Load capacities with fixed jib 15°

Load capacities in 1000 lbs with 66 ft main boom

Radius [ft]	Jib length [ft]			
	36	46	66	85
30	79.1			
40	79.1	75.3	66.4	52.1
50	79.1	69.3	58.1	47.8
60	78.4	64.3	52.1	41.8
70	71.8	60.0	46.0	36.8
80	63.5	53.8	40.6	32.8
90	57.6	50.2	36.8	29.4
100	53.0	45.9	33.3	26.8
110		42.2	30.6	25.7
120			28.5	23.5
125			27.5	22.6
145				19.8

181,440 lbs rear counterweight and 79,400 lbs carbody counterweight

Load capacities in 1000 lbs with 115 ft main boom

Radius [ft]	Jib length [ft]			
	36	46	66	85
25	79.1	79.1		
40	79.1	79.1	68.7	51.6
60	79.1	70.5	57.1	45.1
75	76.3	65.4	50.6	39.2
90	59.6	60.3	44.2	34.0
105	48.3	48.9	39.0	30.3
120	40.0	40.5	35.2	27.1
130	35.5	36.1	32.9	26.6
140	31.7	32.3	31.1	25.1
150		29.0	29.6	23.7
170			24.5	21.4
190				19.5

181,440 lbs rear counterweight and 79,400 lbs carbody counterweight

Load capacities in 1000 lbs with 164 ft main boom

Radius [ft]	Jib length [ft]			
	36	46	66	85
22	79.1			
30	79.1	79.1		
40	79.1	79.1	68.7	
50	79.1	78.2	66.7	48.4
80	68.0	68.8	53.1	39.8
110	43.2	43.9	44.3	32.6
135	31.5	32.1	33.1	28.0
160	23.7	24.2	25.1	25.9
185	18.0	18.4	19.3	20.0
195		16.5	17.4	18.1
215			14.1	14.8
230				12.7

181,440 lbs rear counterweight and 79,400 lbs carbody counterweight

Load capacities in 1000 lbs with 213 ft main boom

Radius [ft]	Jib length [ft]			
	36	46	66	85
23.8	79.1			
30	79.1	79.1		
40	79.1	78.2	64.6	
50	79.1	77.1	62.9	45.5
90	55.8	56.6	53.0	38.7
125	33.6	34.2	35.4	32.1
160	21.7	22.2	23.2	24.0
195	14.1	14.6	15.4	16.2
225	9.6	10.0	10.8	11.5
235		8.7	9.5	10.1
255			7.1	7.8
275				5.8

181,440 lbs rear counterweight and 79,400 lbs carbody counterweight

Load capacities in 1000 lbs with 243 ft main boom

Radius [ft]	Jib length [ft]			
	36	46	66	76
24.8	79.1			
30	79.1	75.9		
40	79.1	75.2	60.4	
50	79.1	74.2	59.1	50.4
95	50.4	51.3	52.1	44.0
135	28.2	28.8	30.0	30.6
175	16.7	17.2	18.2	18.6
215	9.6	10.0	10.8	11.3
250	5.2	5.6	6.4	6.8
260		4.6	5.3	5.7
280			3.4	3.8
290				2.9

181,440 lbs rear counterweight and 79,400 lbs carbody counterweight

TLT 11962445. Above load charts are for reference only. For actual lift duty please refer to load chart in operator's cabin or manual. Otherwise we recommend you to plan your lifting job using Crane Planner 2.0.



www.liebherr.com/CranePlanner

Crane Planner 2.0

Load capacities with fixed jib 30°

Load capacities in 1000 lbs with 66 ft main boom

Radius [ft]	Jib length [ft]			
	36	46	66	85
35	79.1			
50	65.5	55.1	41.3	
60	58.4	50.9	36.4	29.3
70	53.0	45.8	32.8	26.6
80	50.3	41.9	29.9	25.0
90	47.1	38.7	27.5	22.6
100	44.9	36.5	26.6	20.9
110		35.1	25.1	19.3
120			23.9	18.1
130			23.2	17.1
140				16.4
150				16.0

181,440 lbs rear counterweight and 79,400 lbs carbody counterweight

Load capacities in 1000 lbs with 115 ft main boom

Radius [ft]	Jib length [ft]			
	36	46	66	85
29	79.1			
50	73.3	59.9	42.2	
55	70.5	56.9	40.3	
60	67.0	54.6	38.4	28.9
90	53.9	45.3	30.8	24.8
115	43.0	39.5	26.7	21.3
140	31.9	32.6	25.1	18.6
150		29.2	24.2	17.8
160			23.7	17.1
170			23.3	16.6
180				16.3
190				16.1

181,440 lbs rear counterweight and 79,400 lbs carbody counterweight

Load capacities in 1000 lbs with 164 ft main boom

Radius [ft]	Jib length [ft]			
	36	46	66	85
30.7	79.1			
40	79.1	65.4		
50	78.4	62.9	43.0	
55	75.0	61.7	41.8	
65	70.1	57.4	39.0	28.8
125	36.3	37.0	28.6	21.7
185	18.1	18.7	19.8	17.4
195		16.7	17.8	16.9
205			15.9	16.5
215			14.2	15.2
225				13.6
235				12.1

181,440 lbs rear counterweight and 79,400 lbs carbody counterweight

Load capacities in 1000 lbs with 213 ft main boom

Radius [ft]	Jib length [ft]			
	36	46	66	85
32.4	79.1			
40	79.1	63.4		
50	78.5	62.1		
55	77.2	60.5	41.2	
60	75.3	59.2	40.0	
65	72.8	58.0	39.0	28.6
230	9.0	9.5	10.5	11.4
240		8.2	9.1	10.1
245			8.5	9.4
255			7.3	8.2
265				7.0
275				5.9

181,440 lbs rear counterweight and 79,400 lbs carbody counterweight

Load capacities in 1000 lbs with 243 ft main boom

Radius [ft]	Jib length [ft]			
	36	46	66	85
33.5	75.6			
40	75.5	60.7		
50	75.1	59.7		
55	75.0	59.0	40.9	
60	74.8	58.3	40.1	
65	73.6	57.7	39.2	28.3
255	4.8	5.3	6.2	7.1
265		4.2	5.1	6.0
275			4.1	4.9
285			3.1	3.9
295				3.0
300				2.5

181,440 lbs rear counterweight and 79,400 lbs carbody counterweight

TLT 11962445. Above load charts are for reference only. For actual lift duty please refer to load chart in operator's cabin or manual. Otherwise we recommend you to plan your lifting job using Crane Planner 2.0.



www.liebherr.com/CranePlanner

Crane Planner 2.0

Fixed jib 0806.xx

Jib lengths 36-105 ft

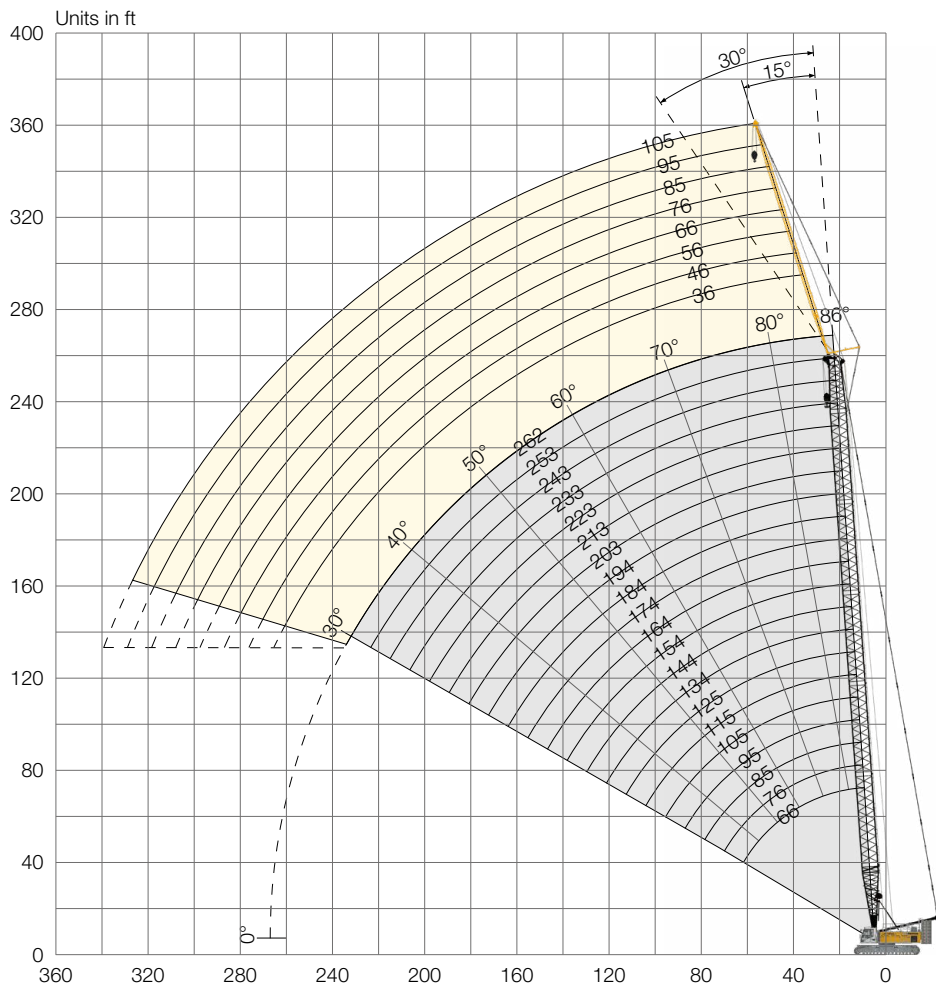

Jib configuration 0806.xx

Jib section	Amount of jib sections							
Jib foot 18 ft	1	1	1	1	1	1	1	1
Jib section 10 ft		1		1		1		1
Jib section 20 ft			1	1	2	2	3	3
Jib head 18 ft	1	1	1	1	1	1	1	1
Jib length [ft]	36	46	56	66	76	85	95	105

Actual lengths of boom sections are metric (e.g. 3 m, 6 m). The figures shown above are approximate conversions to feet. For main boom configuration please refer to the table on page 18.

Load capacities with fixed jib 15°

Load capacities in 1000 lbs with 66 ft main boom

Radius [ft]	Jib length [ft]				
	36	56	76	95	105
35	45.5				
50	41.4	26.4	20.3		
55	40.0	25.5	19.8	14.1	11.5
65	38.0	24.1	18.7	13.3	10.7
75	36.2	22.9	17.9	12.5	10.0
85	34.6	21.9	17.0	11.9	9.4
100	24.2	20.8	15.9	11.0	8.7
110		19.7	15.3	10.6	8.2
120		17.6	14.8	10.1	7.9
135			13.5	9.5	7.4
155				9.2	7.0
165					6.9

181,440 lbs rear counterweight and 79,400 lbs carbody counterweight

Load capacities in 1000 lbs with 115 ft main boom

Radius [ft]	Jib length [ft]				
	36	56	76	95	105
30	49.2				
40	47.1	28.9	21.3		
50	45.2	27.5	20.4	14.5	11.8
65	42.4	25.6	19.4	13.5	10.9
85	39.1	23.7	18.0	12.4	9.9
105	36.5	22.3	16.9	11.5	9.0
125	34.1	21.1	15.9	10.6	8.3
140	32.1	20.3	15.3	10.2	7.9
160		18.9	14.4	9.6	7.4
180			13.3	9.2	7.0
200				9.0	6.9
210					6.8

181,440 lbs rear counterweight and 79,400 lbs carbody counterweight

Load capacities in 1000 lbs with 164 ft main boom

Radius [ft]	Jib length [ft]				
	36	56	76	95	105
22	46.5				
30	45.5	27.9			
40	44.4	27.1	19.3		
50	42.9	26.3	18.8	13.2	11.0
85	39.5	23.8	17.3	12.0	9.8
115	37.5	22.2	16.3	11.2	8.8
150	27.8	20.9	15.4	10.1	7.9
185	19.4	19.6	14.7	9.3	7.2
205		16.9	13.9	9.0	6.9
220			13.3	8.9	6.8
240				8.8	6.7
250					6.7

181,440 lbs rear counterweight and 79,400 lbs carbody counterweight

Load capacities in 1000 lbs with 213 ft main boom

Radius [ft]	Jib length [ft]				
	36	56	76	95	105
23.8	41.0				
40	39.8	25.4	17.5		
50	39.2	24.8	17.2	11.9	
55	38.8	24.6	17.0	11.8	9.8
95	36.7	22.7	15.8	10.9	9.0
135	30.9	21.3	15.0	10.3	8.4
180	18.4	19.6	14.3	9.7	7.7
225	11.0	12.1	13.0	9.1	7.1
245		9.6	10.5	8.9	6.8
265			8.4	8.9	6.8
285				7.3	6.8
295					6.7

181,440 lbs rear counterweight and 79,400 lbs carbody counterweight

Load capacities in 1000 lbs with 262 ft main boom

Radius [ft]	Jib length [ft]				
	36	46	56	66	76
25.5	32.9				
30	32.8	25.7			
40	32.4	25.4	19.8	16.8	
50	32.0	25.0	19.5	16.6	13.4
105	29.9	23.5	18.3	15.8	12.8
155	22.2	22.2	17.8	15.4	12.4
205	11.7	12.3	12.9	13.3	11.7
270	3.9	4.4	4.9	5.4	5.8
280		3.5	4.0	4.4	4.9
290			3.1	3.6	4.0
300				2.8	3.2
310					2.5

181,440 lbs rear counterweight and 79,400 lbs carbody counterweight

TLT 11962445. Above load charts are for reference only. For actual lift duty please refer to load chart in operator's cabin or manual. Otherwise we recommend you to plan your lifting job using Crane Planner 2.0.



www.liebherr.com/CranePlanner

Crane Planner 2.0

Load capacities with fixed jib 30°

Load capacities in 1000 lbs with 66 ft main boom

Radius [ft]	Jib length [ft]				
	36	56	76	95	105
45	38.5				
55	36.8	23.2			
65	35.2	22.4	17.3		
70	34.7	22.0	16.9	11.9	
75	33.2	21.6	16.6	11.6	9.2
85	30.6	21.0	15.9	11.1	8.8
100	28.2	19.3	14.9	10.4	8.1
110		18.4	14.2	10.0	7.8
120		17.6	13.3	9.7	7.5
140			12.5	9.3	7.1
160				9.1	6.9
170					6.9

181,440 lbs rear counterweight and 79,400 lbs carbody counterweight

Load capacities in 1000 lbs with 115 ft main boom

Radius [ft]	Jib length [ft]				
	36	56	76	95	105
35	42.0				
50	39.6	24.2			
55	39.0	23.8	18.2		
70	37.1	22.8	17.3	11.9	
75	36.5	22.4	17.0	11.7	9.2
95	34.5	21.4	16.1	10.9	8.5
115	30.8	20.6	15.2	10.3	8.0
140	28.3	18.7	13.9	9.7	7.5
160		17.6	13.0	9.4	7.2
180			12.6	9.2	7.0
200				9.1	6.9
210					6.9

181,440 lbs rear counterweight and 79,400 lbs carbody counterweight

Load capacities in 1000 lbs with 164 ft main boom

Radius [ft]	Jib length [ft]				
	36	56	76	95	105
30.7	40.1				
50	38.8	23.5			
60	38.2	23.1	17.0		
70	37.6	22.6	16.7	11.6	
75	37.3	22.4	16.6	11.4	8.9
115	34.5	21.1	15.6	10.3	8.0
150	28.3	19.8	14.6	9.6	7.4
185	19.6	18.2	13.1	9.2	7.1
205		17.1	12.8	9.1	7.0
225			12.5	9.1	6.9
245				9.1	6.9
255					6.9

181,440 lbs rear counterweight and 79,400 lbs carbody counterweight

Load capacities in 1000 lbs with 213 ft main boom

Radius [ft]	Jib length [ft]				
	36	56	76	95	105
32.4	36.5				
50	35.9	22.5			
60	35.7	22.2	15.9		
70	35.7	21.9	15.7	10.8	
80	35.6	21.6	15.6	10.6	8.7
130	33.7	20.7	15.1	10.1	8.0
180	18.9	19.5	14.4	9.5	7.4
230	10.5	11.7	12.9	9.2	7.1
245		9.8	10.9	9.2	7.1
265			8.5	9.1	7.1
285				7.5	7.1
295					6.9

181,440 lbs rear counterweight and 79,400 lbs carbody counterweight

Load capacities in 1000 lbs with 262 ft main boom

Radius [ft]	Jib length [ft]				
	36	46	56	66	76
34.2	30.7				
50	30.5	24.6	19.3		
55	30.4	24.6	19.1	16.7	
60	30.4	24.5	19.0	16.7	13.2
115	29.8	24.1	18.7	16.2	12.9
165	20.3	21.1	18.7	15.7	12.8
215	10.6	11.3	12.0	12.6	12.4
270	4.0	4.6	5.2	5.7	6.3
280		3.6	4.2	4.7	5.3
290			3.3	3.8	4.4
300				2.9	3.5
310					2.6

181,440 lbs rear counterweight and 79,400 lbs carbody counterweight

TLT 11962445. Above load charts are for reference only. For actual lift duty please refer to load chart in operator's cabin or manual. Otherwise we recommend you to plan your lifting job using Crane Planner 2.0.



www.liebherr.com/CranePlanner

Crane Planner 2.0

Fixed jib 0906.21

Jib length 23 ft

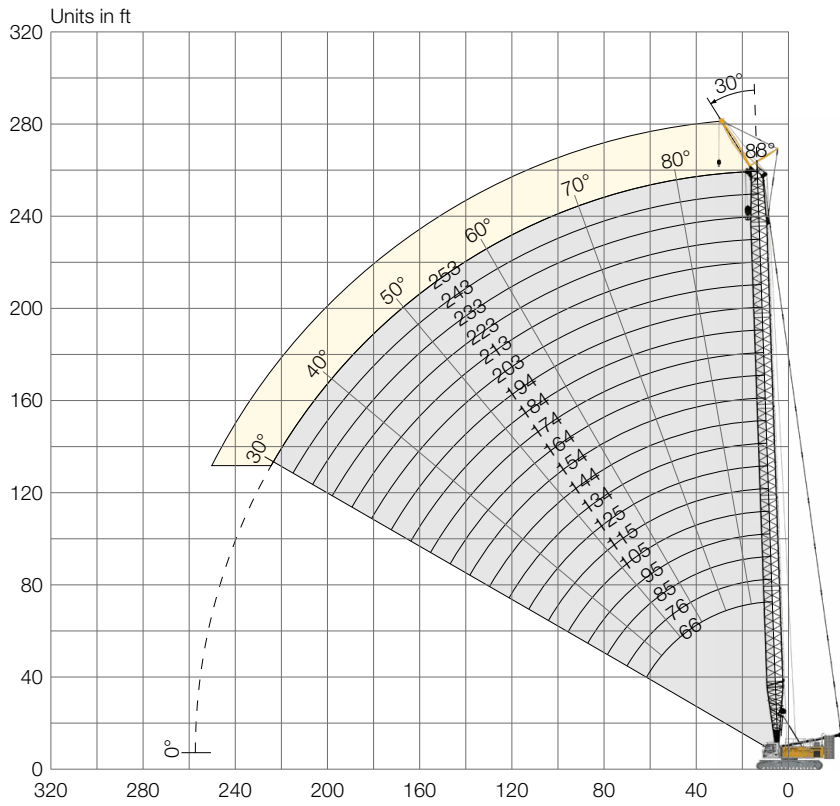

The jib length is 23 ft, for main boom configuration please refer to the table on page 18.

Load capacities with fixed jib 30°

Load capacities in 1000 lbs with 66 ft main boom

Radius [ft]	Jib length 23 ft
35	134.2
40	130.7
50	124.6
55	116.8
60	104.0
65	93.4
70	84.6
75	77.1
80	70.7
85	65.0

181,440 lbs rear counterweight and 79,400 lbs carbody counterweight

Load capacities in 1000 lbs with 115 ft main boom

Radius [ft]	Jib length 23 ft
30	155.8
50	132.0
60	102.9
70	83.5
80	69.6
90	59.2
100	51.1
110	44.6
120	39.1
130	34.5

181,440 lbs rear counterweight and 79,400 lbs carbody counterweight

Load capacities in 1000 lbs with 164 ft main boom

Radius [ft]	Jib length 23 ft
25.9	155.8
50	131.0
65	90.9
75	74.5
90	57.5
100	49.4
115	40.0
125	35.1
140	29.1
150	25.8
170	20.3

181,440 lbs rear counterweight and 79,400 lbs carbody counterweight

Load capacities in 1000 lbs with 213 ft main boom

Radius [ft]	Jib length 23 ft
27.6	123.0
55	113.5
70	80.6
90	55.9
105	44.3
125	33.3
140	27.3
160	21.2
175	17.5
195	13.5
215	10.1

181,440 lbs rear counterweight and 79,400 lbs carbody counterweight

Load capacities in 1000 lbs with 253 ft main boom

Radius [ft]	Jib length 23 ft
29	89.2
55	86.5
75	71.7
95	50.2
115	36.8
135	27.6
160	19.6
180	14.8
200	11.0
220	7.9
250	4.1

181,440 lbs rear counterweight and 79,400 lbs carbody counterweight

TLT 11962445. Above load charts are for reference only. For actual lift duty please refer to load chart in operator's cabin or manual. Otherwise we recommend you to plan your lifting job using Crane Planner 2.0.



www.liebherr.com/CranePlanner

 **Crane Planner 2.0**

The Liebherr Group of Companies



Wide Product Range

The Liebherr Group is one of the largest construction equipment manufacturers in the world. Liebherr's high-value products and services enjoy a high reputation in many other fields. The wide range includes domestic appliances, aerospace and transportation systems, machine tools and maritime cranes.

Exceptional Customer Benefit

Every product line provides a complete range of models in many different versions. With both their technical excellence and acknowledged quality, Liebherr products offer a maximum of customer benefits in practical applications.

State-of-the-art Technology

To provide consistent, top quality products, Liebherr attaches great importance to each product area, its components and core technologies. Important modules and components are developed and manufactured in-house, for instance the entire drive and control technology for construction equipment.

Worldwide and Independent

Hans Liebherr founded the Liebherr family company in 1949. Since then, the family business has steadily grown to a group of more than 130 companies with nearly 44,000 employees located on all continents. The corporate headquarters of the Group is Liebherr-International AG in Bulle, Switzerland. The Liebherr family is the sole owner of the company.

www.liebherr.com



Please contact us.



Download datasheet

Liebherr-Werk Nenzing GmbH

Dr. Hans Liebherr Str. 1, 6710 Nenzing/Austria
☎ +43 50809 41-473, Fax: +43 50809 41-499
www.liebherr.com, crawler.cranes@liebherr.com
[facebook.com/LiebherrConstruction](https://www.facebook.com/LiebherrConstruction)

Liebherr USA, Co.

7075 Bennington Street, Houston, TX 77028-5812
☎ (713) 636-4050, Fax: (713) 636-4051
www.liebherr.com, crawler.cranes.usa@liebherr.com
[facebook.com/LiebherrConstruction](https://www.facebook.com/LiebherrConstruction)