

Manitex



CM350

35-ton (32 mt) TELESCOPIC CRANE
CM350 SERIES PRODUCT GUIDE

CONTENTS

Crane Features	4
35100C Chassis	5
35124C Chassis	6
Outrigger Extension	7
35100C Load Chart: Main Boom	8
35100C Boom Diagram	9
35124C Load Chart: Main Boom and jib	10
35124C Boom Diagram	11
Area of Operation	12
Reeving Diagram	12
LMI Codes	13
Warning, Information & Definitions	13
Technical Descriptions	14-15
Options	15

Effective Date: September 1, 2013

This document is non-contractual. This document is supplied for reference use only. We are constantly making improvements to our products and reserve the right that specification, equipment, and prices are all subject to change without notice or obligation.

The photographs, and /or images in this document are for illustrative purposes only and may include optional equipment and accessories and may not include all standard equipment.

Refer to the appropriate Operator's Manual and Load Charts for instructions on the proper use of this equipment to determine allowable crane lifting capacities, assembly and operating procedures.

Failure to follow the appropriate operator's manual or load chart(s) when using our equipment or to otherwise act irresponsibly may result in serious injury or death.

The only warranty applicable to our equipment is the standard written warranty applicable to the particular product and sale. Manitex makes no other warranty, expressed or implied.



















Products and services listed may be trademarks, service marks or trade-names of Manitex International and /or its subsidiaries in the USA and other countries.

















All rights are reserved. Manitex® is a registered trademark of Manitex International, Inc. in the USA and many other countries.

Copyright 2013 Manitex Inc. Manitex Inc, Georgetown Texas, 78626



KEY

	Operator aids
	Cab
	Heating / Air conditioning
	Controls
	Hoist speed
	1 - Main hoist 2 - Auxiliary winch 3 - Recovery winch
	Rope length
	Rope - standard/optional
	Rope diameter
	Permissible line pull
	Maximum line pull
	Slewing / Allowable slewing range
	Slewing gears
	Slewing brake
	Outriggers / Lifting on outriggers
	2-Person man basket
	Counterweight
	Radio remote control

	Hook block
	Distance from hook to head sheave pin
	Hook and ball
	Hydraulics
	Boom elevation angle
	Max. boom length with extension
	Boom with extension retracted
	Boom angle
	Telescoping mode
	Working radius
	Boom length
	Hydraulic actuated boom
	Full power mechanical synchronized
	Boom head / Hook block dimension
	Main boom with auxiliary head
	Tip height



THE CM350 SERIES TELESCOPIC CRANE Maximize use and value

The CM350 series strikes the perfect balance between the three things customers tell us they care about most: features, cost and ease of use.

The CM350 offers:

- A Greer Insight™ load moment indicator, the industry's only monitoring display that offers the feature-rich capabilities and high-resolution VGA graphics to help operators work safer and smarter
- Self-lubricating boom slider pads, to minimize maintenance costs
- A compact size; properly equipped, the unit is just 43 ft. long

Other features include:

- 35-ton capacity @ 6 ft. radius
- 100 ft. 4-Section proportional boom
- 124 ft. 5-section proportional boom
- Optional fixed & telescopic jib
- Out-and-down outriggers
- Out-and-down stabilizers

USER-FRIENDLY CONTROLS

Dual operator stations are equipped with engine start/stop, foot throttle, signal horn, boom angle indicator, load chart bubble level and range diagram.



OUTRIGGER DEPLOYMENT

Equipped with double-acting hydraulic cylinders, pivoting pads and audible alerts when outriggers/stabilizers are in motion.

TWO-SPEED PLANETARY HOIST

The two-speed planetary hoist lets you change line speed on the fly and minimize rope stacking to increase productivity and minimize downtime.

INCREASE PROFITABILITY

The versatile CM350 series, designed to be used with a commercial carrier, helps both owners and operators make the most of their investment.

- Travel to and between jobs at highway speed.
- Ride in comfort with a carrier suspension designed for highway driving.
- Get repairs done quickly and by qualified technicians at commercial truck centers.



35100C CHASSIS

35100C Dimensions

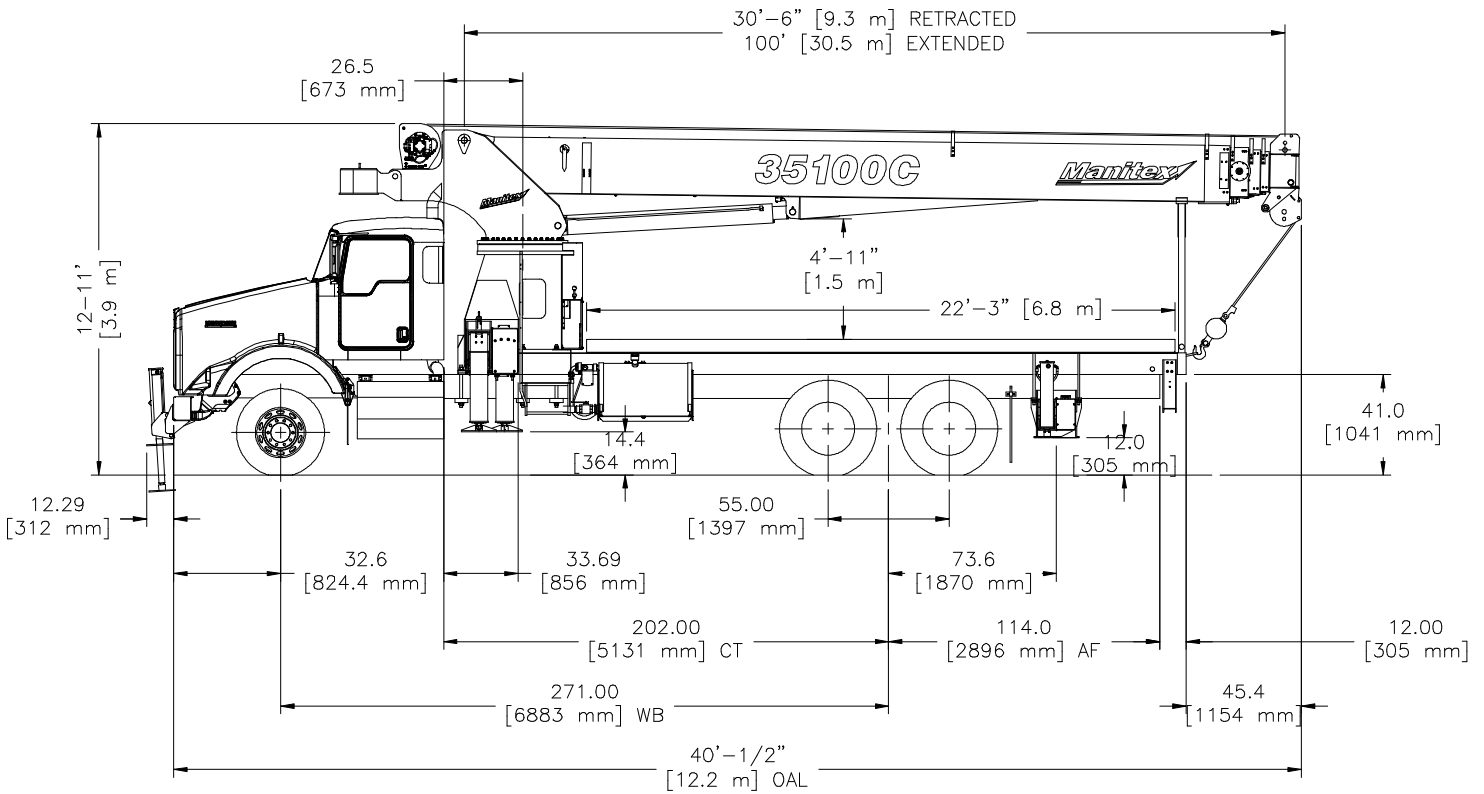

CRANE WEIGHT

Total crane (standard):	29,580 lbs. (13,417 kg)
22' Flatbed Weight	1980 lbs.(898 kg)

CHASSIS DATA

Wheel Base (WB)	271 in. (6,883 mm)
Cab to Tandem (CT)	202 in. (4,877 mm)
After Frame (AF)	114 in. (2,896 mm)
Nominal frame width	34 in. (864 mm)
Frame Section Modulus at 180/360° area of operation*	30 in. ³ (491.6 cm ³) 125,000 psi (861,875 kPa)

* Frame selection modulus at 360° area of operation requires front bumper stabilizer.

TRUCK AXLE WEIGHT

Minimum truck axle weight - Front**	8,450 lbs.(3,674 kg)
Minimum truck axle weight - Back**	8,300 lbs.(3, 765 kg)
Front Axle Gross Weight Rating	20,000 lbs.(8,185 kg)
Rear Axle Gross Weight Rating	40,000 lbs. (18,144 kg)

** Minimum chassis weight is required to meet 85% stability requirements. Chassis data is general - not for engineering. Some dimensions depend on truck selection.

Notes: Additional axles required for federal bridge legal configuration - consult Manitex. Manitex highly recommends addition of a front stabilizer and may be required on some installations - consult Manitex.

35124C CHASSIS

35124C Model

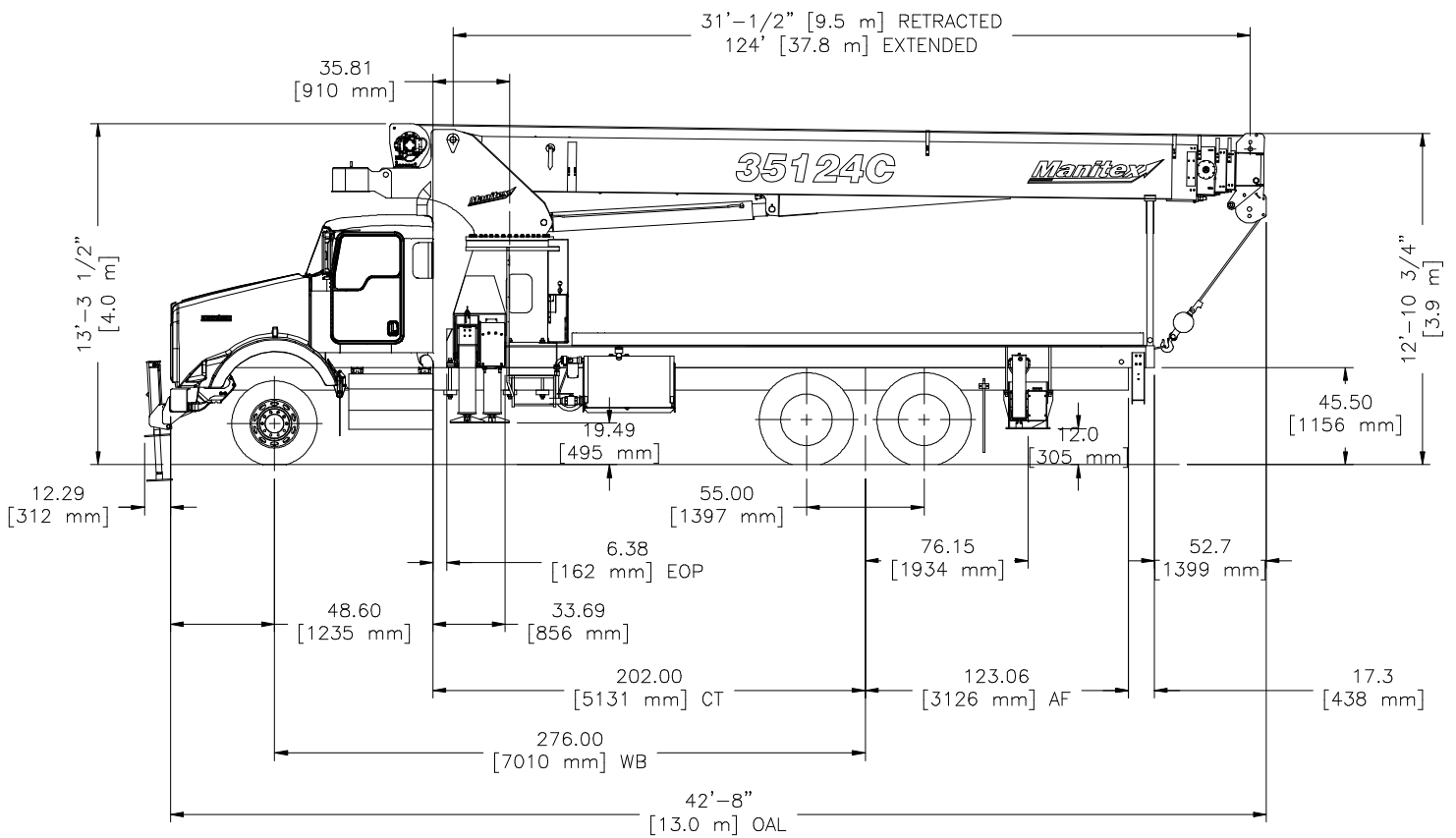

CRANE WEIGHTS

Total crane (standard):	32,260 lbs.
22' Flatbed Weight	1980 lbs.

TRUCK AXLE WEIGHT

Minimum truck axle weight - Front**	8,450 lbs. (3,674 kg)
Minimum truck axle weight - Rear**	8,300 lbs. (3,765) kg
Front Axle Gross Weight Rating	20,000 lbs. (8,185 kg)
Rear Axle Gross Weight Rating	40,000 lbs. (18,144 kg)

** Minimum chassis weight is required to meet 85% stability requirements. Chassis data is general - not for engineering. Some dimensions depend on truck selection.

Notes: Additional axles required for federal bridge legal configuration - consult Manitex. Manitex highly recommends addition of a front stabilizer and may be required on some installations - consult Manitex.

CHASSIS DATA

Wheel Base (WB)	271 in. (6,883mm)
Cab to Tandem (CT)	202 in. (4,877 mm)
After Frame (AF)	114 in. (2,896 mm)
Nominal frame width	34 in. (864 mm)
Frame Section Modulus at 180/360° area of operation*	30 in. ³ (491.6 cm ³) 125,000 psi (861 875 kPa)

* Frame selection modulus at 360° area of operation requires front bumper stabilizer.



OUTRIGGER EXTENSION

Outrigger-Stabilizer Combination
Intermediate Extended - Imperial & Metric Units

Outrigger-Stabilizer Combination
Fully Extended (optional)

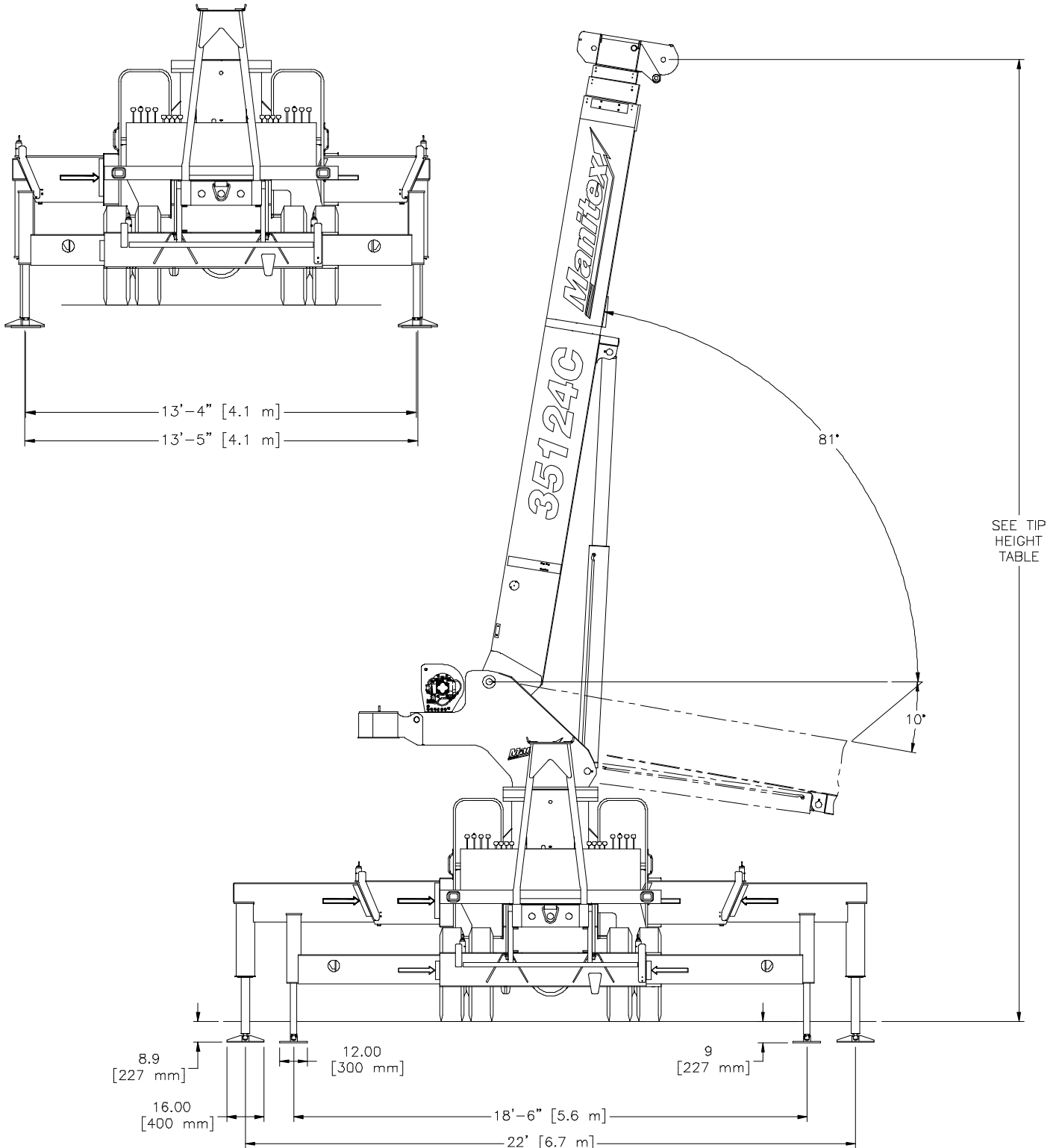

Data published herein is intended as a guide only. Crane operation is subject to machine specific load charts and information.

35100C LOAD CHART: Main Boom

Lifting Capacities 4-section Boom 30.5 ft. - 100 ft.

Outriggers  22 ft. (100%)
 Stabilizers  18 ft. 6 in. (100%)

 360° Non-continuous

MAIN BOOM LMI CODE 1											JIB LOAD CAPACITIES						
30.5 ft.			52 ft. (A)		68 ft. (B)		84 ft. (C)		100 ft. (D)		30.5 ft. Fixed Jib		30.5 ft. Tele. Jib		55 ft. Tele. Jib		
Loaded Boom Angle (deg)	Load Capacity (lbs.)	Loaded Boom Angle (deg)	Load Capacity (lbs.)	Loaded Boom Angle (deg)	Load Capacity (lbs.)	Loaded Boom Angle (deg)	Load Capacity (lbs.)	Loaded Boom Angle (deg)	Load Capacity (lbs.)	Loaded Boom Angle (deg)	Load Capacity (lbs.)	Loaded Boom Angle (deg)	Load Capacity (lbs.)	Loaded Boom Angle (deg)	Load Capacity (lbs.)	Loaded Boom Angle (deg)	Load Capacity (lbs.)
												Code 2	Code 3		Code 4		
6	80	70,000															
8	76	53,500															
10	72	45,670															
12	68	39,830	78	31,500													
15	61	33,660	75	30,330	79	28,500											
20	49	24,380	69	23,790	75	22,580	79	21,780	80	14,000							
25	33	18,310	62	18,810	70	18,470	75	17,690	78	13,500							
30			56	14,700	65	14,850	71	14,760	75	13,000	79	7,300	79	7,000			
35			48	11,350	60	11,530	67	11,630	72	11,170	77	7,100	77	6,800	80	4,000	
40			40	8,910	55	9,070	63	9,170	69	9,240	75	6,800	75	6,670	78	3,850	
45			29	7,120	50	7,290	59	7,380	66	7,440	73	6,450	73	6,060	76	3,700	
50					43	5,930	55	6,020	62	6,080	71	5,900	71	5,510	74	3,550	
55					36	4,860	51	4,950	59	5,000	68	5,200	68	4,790	72	3,400	
60					27	3,990	46	4,080	55	4,140	65	4,330	65	3,920	70	3,250	
65					12	3,280	40	3,370	51	3,430	63	3,610	63	3,200	68	3,040	
70							34	2,770	47	2,830	60	3,010	60	2,600	66	2,830	
75							27	2,270	43	2,320	57	2,500	57	2,090	64	2,640	
80							15	1,830	38	1,880	55	2,060	55	1,650	62	2,310	
85									33	1,500	52	1,680	52	1,260	60	1,920	
90									26	1,170	49	1,350	49	930	58	1,580	
95									17	870	45	1,050	45	630	55	1,280	
100											42	790			53	1,010	
105											38	550			50	770	
110															47	560	
DEDUCTIONS FROM MAIN BOOM CAPACITIES FOR STOWED JIB - FJ = Fixed Jib TJ = Telescopic Jib																	
FJ	600 lbs.	350 lbs.	270 lbs.	220 lbs.	180 lbs.												
TJ	900 lbs.	530 lbs.	400 lbs.	330 lbs.	290 lbs.												

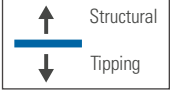

NOTES:

- All loads rated at 360° pick
- Loads based on crane on fully extended outriggers and stabilizers
- All "on outriggers" loads are based on 85% tipping
- Loads above heavy line are based on structural rating
- Loads below heavy line are based on tipping rating

Data published herein is intended as a guide only. Crane operation is subject to machine specific load charts and information.



35100C BOOM DIAGRAM

RANGE DIAGRAM - FULL SPREAD CONFIGURATION -

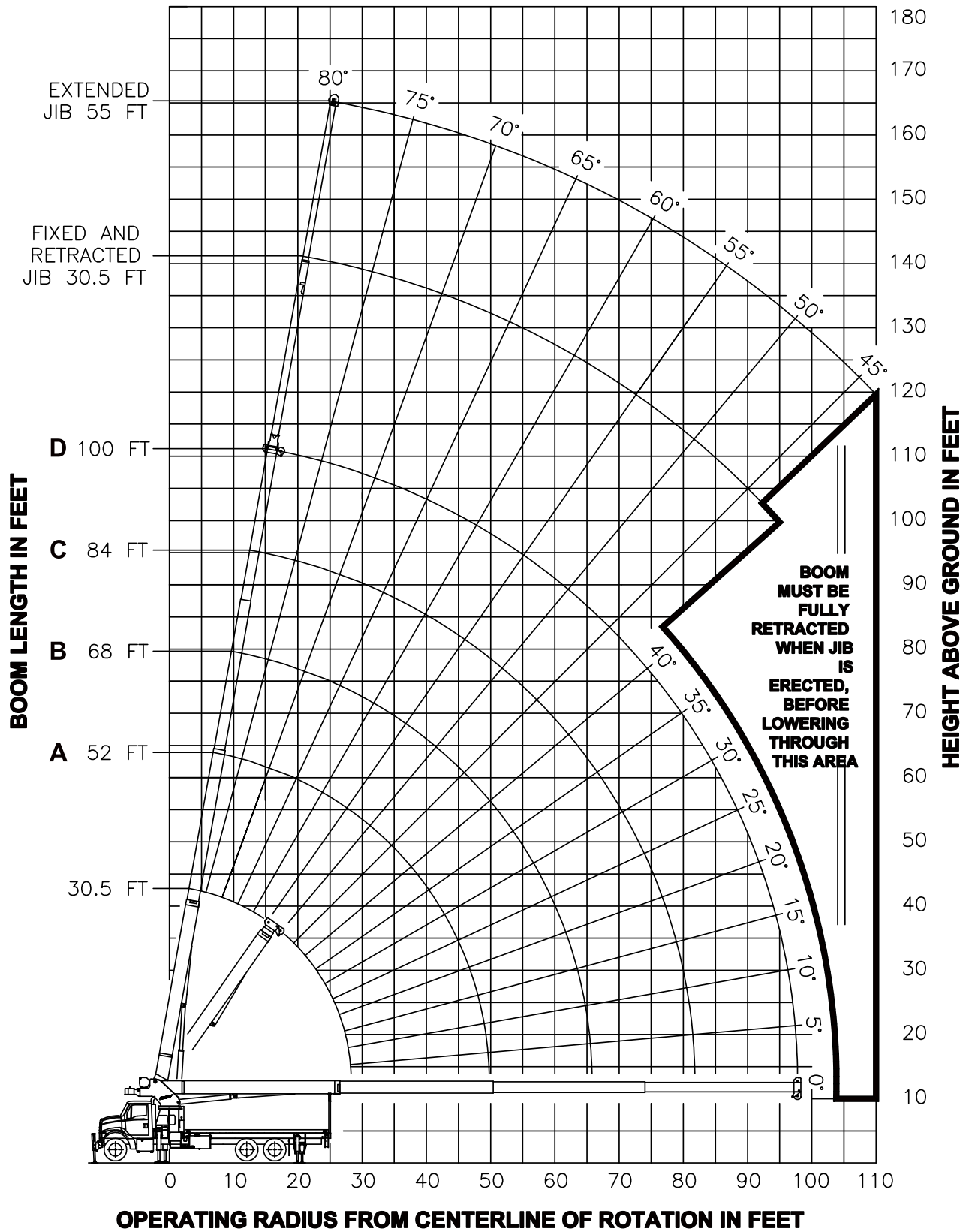

Data published herein is intended as a guide only. Crane operation is subject to machine specific load charts and information.

35124C LOAD CHART: Main Boom and Jib

Lifting Capacities 5-section Boom 31 ft. - 124 ft.
Jib 26 ft. - 46 ft.

Outriggers 22 ft. (100%) Stabilizers 18 ft. 6 in. (100%) 360° Non-continuous

MAIN BOOM LMI CODE 1											IB LOAD CAPACITIES LMI CODE 2	
31 ft.			58 ft. (A)		80 ft. (B)		102 ft. (C)		123.7 ft. (D)		31 ft. Jib	
	Loaded Boom Angle (deg)	Load Capacity (lbs.)	Loaded Boom Angle (deg)	Load Capacity (lbs.)	Loaded Boom Angle (deg)	Load Capacity (lbs.)	Loaded Boom Angle (deg)	Load Capacity (lbs.)	Loaded Boom Angle (deg)	Load Capacity (lbs.)	Loaded Boom Angle (deg)	Load Capacity (lbs.)
6	81	70,000										
8	76	53,390										
10	72	45,380										
12	68	39,420	79	25,000								
15	61	33,110	76	25,000	81	21,500						
20	49	23,710	71	22,870	78	19,700	81	14,500				
25	34	17,680	65	18,280	74	17,420	79	13,500	81	8,450		
30			60	14,150	70	14,320	76	12,820	79	8,150	81	4,000
35			53	11,080	66	11,270	73	11,370	76	7,800	79	3,850
40			47	8,590	62	8,770	69	8,870	74	7,280	77	3,700
45			39	6,780	57	6,960	66	7,050	72	6,780	75	3,550
50			29	5,400	52	5,580	63	5,660	69	5,710	73	3,400
55			13	4,320	47	4,490	59	4,570	66	4,620	71	3,250
60					42	3,620	56	3,700	64	3,740	69	3,080
65					36	2,890	52	2,970	61	3,020	67	2,910
70					28	2,290	48	2,370	58	2,410	66	2,740
75					18	1,770	44	1,850	55	1,900	64	2,220
80							39	1,410	52	1,450	62	1,770
85							34	1,030	49	1,070	60	1,390
90							28	690	45	730	57	1,050
95											55	750
DEDUCTIONS FROM MAIN BOOM CAPACITIES FOR STOWED JIB												
	450 lbs.		240 lbs.		180 lbs.		140 lbs.		120 lbs.			

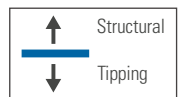

NOTES:

- All loads rated at 360° pick
- Loads based on crane on fully extended outriggers and stabilizers
- All "on outriggers" loads are based on 85% tipping
- Loads above heavy line are based on structural rating
- Loads below heavy line are based on tipping rating

Data published herein is intended as a guide only. Crane operation is subject to machine specific load charts and information.



35124C BOOM DIAGRAM

RANGE DIAGRAM - FULL SPREAD CONFIGURATION -

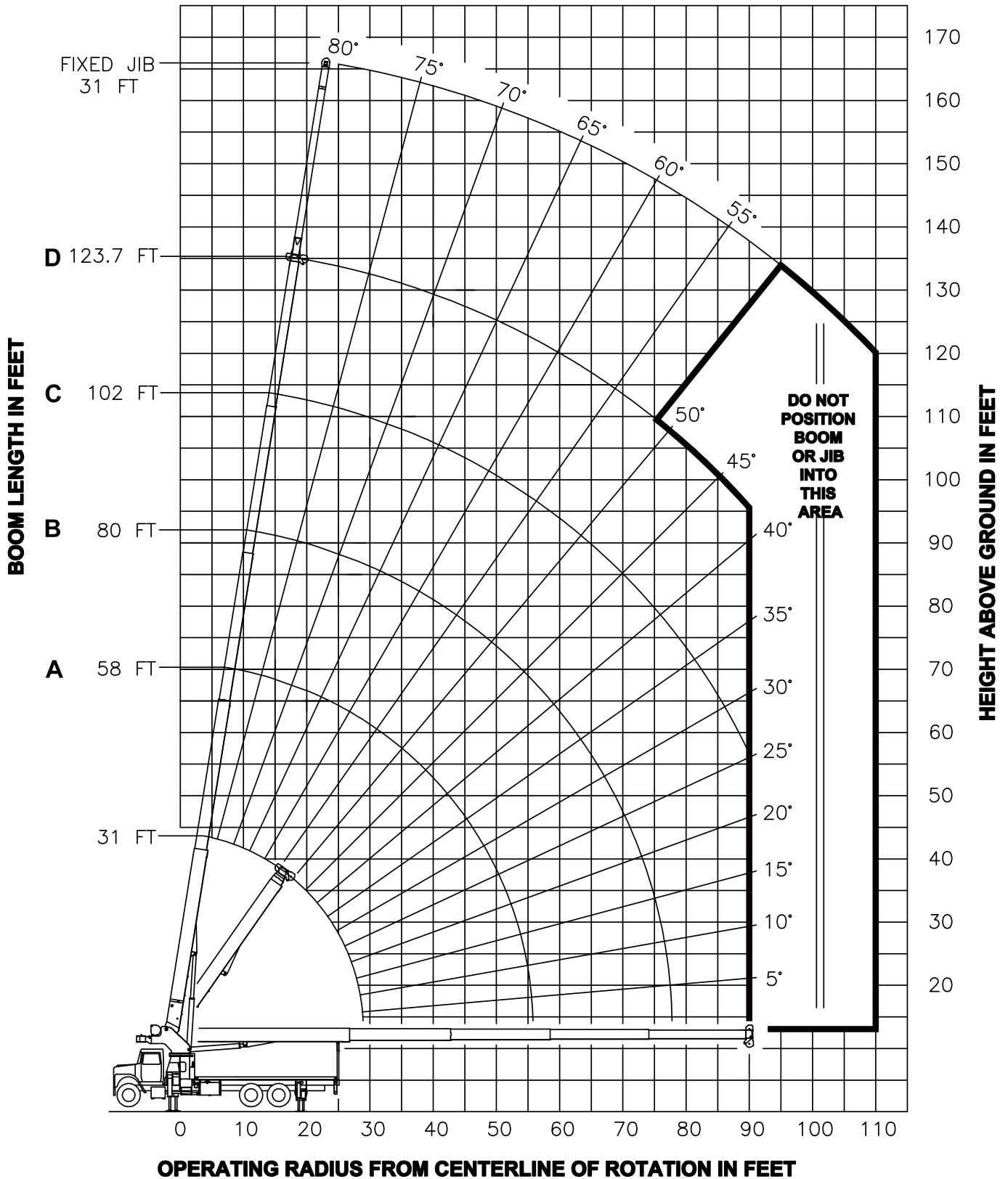

Data published herein is intended as a guide only. Crane operation is subject to machine specific load charts and information.

AREA OF OPERATION

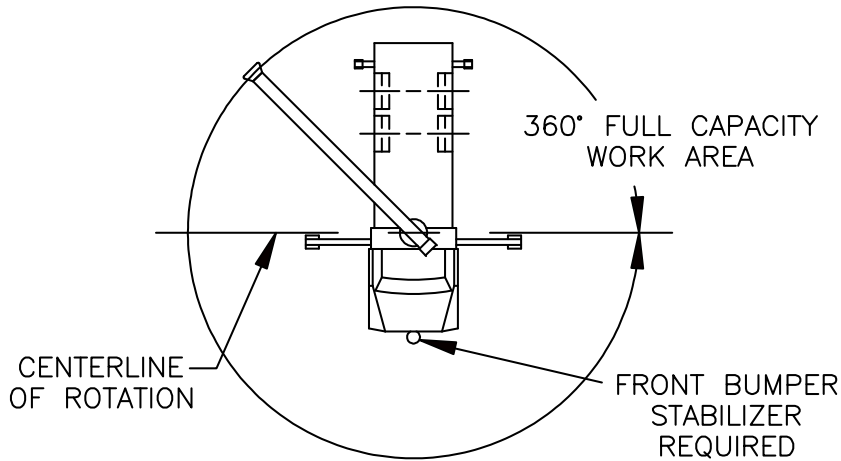

Deductions from rated loads for load handling devices supplied by Manitex

Auxiliary block	50 lbs. (22,7 kg)
Auxiliary sheave	50 lbs. (22,7 kg)
Overhaul ball	See overhaul ball mfr. nameplate
Load blocks	See block mfr. nameplate
Hose reel	260 lbs. (117,9 kg)
Swing around jib	See load chart

WARNING: Lifting off the main boom point while the jib is erected is not intended nor approved.

REEVING DIAGRAM

ALLOWABLE LINE PULL								WARNING
1 PART LINE	2 PART LINE	3 PART LINE	4 PART LINE	5 PART LINE	6 PART LINE	7 PART LINE	8 PART LINE	
9080 LBS	18160 LBS	27240 LBS	36320 LBS	45400 LBS	54480 LBS	63560 LBS	70000 LBS	
9500 LBS	19000 LBS	28500 LBS	38000 LBS	47500 LBS	57000 LBS	66500 LBS	70000 LBS	

ANTI-TWO-BLOCK SYSTEM MUST BE IN GOOD OPERATING CONDITION BEFORE OPERATING CRANE.

REFER TO THE OWNER'S MANUAL.

KEEP AT LEAST 3 WRAPS OF LOAD LINE ON THE DRUM AT ALL TIMES.

5/8" ROT RESISTANT (5.0:1 SF) - 45400 LBS MIN BREAKING STRENGTH

5/8" 6 X 25 IWRC (3.5:1 SF) - 33250 LBS MIN BREAKING STRENGTH

LMI OPERATING CODES

Code	Crane Configuration	Outrigger Configuration
#1	Main Boom	Fully Extended
#2	Fixed Jib	Fully Extended
#3	Telescopic Jib - Retracted	Fully Extended
#4	Telescopic Jib - Extended	Fully Extended
#5	Personnel lifting platform on main boom	Fully Extended
#6	Personnel lifting platform on fixed jib	Fully Extended
#7	Personnel lifting platform on tele. jib - Retracted	Fully Extended
#8	Personnel lifting platform on tele. jib - Extended	Fully Extended
#9	Main Boom	Intermediate
#10	Fixed Jib	Intermediate
#11	Telescopic Jib - Retracted	Intermediate
#12	Telescopic Jib - Extended	Intermediate

Warning

1. The operator must read and understand the owner's manual before operating the crane.
2. Positioning or operation of crane beyond areas shown on these charts is not intended or approved except where specified in owner's manual.
3. Loaded boom angles at specified boom lengths give only an approximation of the operating radius. The boom angle before loading should be greater to account for deflections. Do not exceed the operating radius for rated loads.
4. The operating radius shown in the jib rating chart is for fully extended boom only. When boom is not fully extended, use only loaded boom angle to determine load rating of jib.
5. For boom angles not shown on jib load rating chart, use rating of next lower boom angle.
6. For boom lengths not shown, use rating of next shorter or longer boom length, whichever is less. For radii not shown, use rating of next longer radius.
7. Crane load ratings on outriggers are based on freely suspended loads with the machine leveled and standing on a firm uniform supporting surface. No attempt shall be made to move a load horizontally on the ground in any direction.
8. Practical working loads depend on supporting surface, wind, and other factors affecting stability such as hazardous surroundings, experience of personnel, and proper handling, all of which must be taken into account by the operator.
9. The maximum load which may be telescoped is limited by hydraulic pressure, boom angle, and boom lubrication. It is safe to attempt to telescope any load within the limits of the load rating chart.
10. Lifting off the main boom point while the swing around jib is erected is not intended or approved.
11. 360° area of operation is only valid with the use of a front bumper stabilizer.

Definitions

1. Operating radius is the horizontal distance from the axis of rotation to the center of the vertical hoist line or tackle with load applied.
2. Loaded boom angle as shown in the column head, is the included angle between the horizontal and longitudinal axes of the boom base after lifting rated load at rated radius.

TECHNICAL DESCRIPTIONS

Boom



- Boom length: Proportional boom
- 4 –section 100 ft. (30,5 m)
 - 5 –section 124 ft. (37,8 m)

2 upper & 3 lower quick reeve boom point
Self lubricating slider pads



- 35100C:
- Boom max. tip height 111 ft. 4 in. (33.9 m)
 - Boom min. tip height 100 ft. (30.5 m)

- 35124C:
- Boom max. tip height: 134 ft. 8 in. (40.8 m)
 - Boom min. tip height: 124 ft. (37.8 m)



Boom angle (min/max): -9° / 80.6°

Rotation



Ball-bearing swing circle with external gear
Double-reduction planetary gearbox driven by hydraulic motor



Slewing brake: Spring-applied pressure released parking brake



Slewing speed: 0 - 1.5 rpm
Boom rotation: 372° non-continuous

Outriggers



Outriggers: Out and Down Style
FBS - Front Bumper Stabilizer (optional)
Outriggers fully extended:

- 22 ft. (6.7 m)

Stabilizers fully extended:

- 18 ft. 6 in. (5.6 m)

Hoist, Rope and Hook



Maximum theoretical line-speed:
453 fpm (138 mpm)



Maximum theoretical bottom-layer line pull:
14,500 lbs. (6,577 kg)



Main winch cable diameter: 5/8 in.
(16 mm) rotation resistant



Line length: 380 ft. (115.8 m)



Main winch: Bent axis 2-speed hydraulic motor (activated electrically)



Hook & ball: 5 T (4.5 mt) capacity hook with heavy-duty swivel and weight is provided for single line operation.

Hydraulics



8-Bolt direct mounted PTO and SAE B input and SAE BB output
3-Section Gear Pump standard CCW Rotation
Hydraulic reservoir capacity:
115 Gallons (435 liter)
Pump sections @ 2000 rpm with 100 psi

- Shaft end pump: 38.4 GPM (145 lpm)
- Center pump: 27.4 GPM (104 lpm)
- Cover end pump: 11.2 GPM (42 lpm)

Operator aids



External Wired LMI with crane function cut-offs for overload protection
Wired anti-two block system

TECHNICAL DESCRIPTIONS

Control System



Dual operating stations are equipped with four single-lever crane controls arranged in accordance with ANSI B30.5 standards.

Fully proportional control valves

Each station includes:

- Individual control levers for each outrigger and stabilizer
- Engine start and stop
- Electronic foot throttle
- Signal horn
- Boom angle indicator
- Beverage holder
- Load chart with range diagram and mount for removable LMI display

Electrical System

State-of-the-art, weather-resistant components throughout

Hermetically sealed enclosure includes power in relays and circuit status LEDs

Mounting System

Pedestal sub-frame and stabilizers are mounted to chassis by threaded rods and clamp plates

Sub-frame: Torsion resistant, rigid 4-plate design mounted under crane full length of truck frame

Rear under-ride protection: Standard on factory mounted cranes.

Boom rest: Heavy-duty fabrication, easily removed

Options

Flatbeds

- 22 in. (6.7 m) wood bed
- 22 in. (6.7 m) steel bed
- 22 in. (6.7 m) Heavy Hauler Flatbed 3/16 in. Steel

Options

Jib

35100C:

- 1 section fixed jib 30 ft. 6 in. (9.3 m)
- 2 section telescopic jib 30 ft. 6 in. – 55 ft. 6 in.

35124C:

- 1 section fixed jib 31 ft. (9.4 m)

Max. Tip Height with Extension



35100C:

- Max. tip height with extension: 166 ft. 8 in.
- Max. tip height with extension retracted: 142 ft. 1 in.



35124C:

- Max. tip height with extension: 165 ft. 11 in.
- Max. tip height with extension retracted: 142 ft. 1 in.

Hoist, Rope and Hook



5/8 in. (15.9 mm) diameter 6 x 25 EIPS IWRC wire rope

Hydraulics



3 Section Vane Pump, CCW or CW
FBS – Front Bumper Stabilizer
Hydraulic Oil cooler
Hose Reel

2-Person Baskets



2-person man basket - Aluminum or steel - consult Manitex

- Non-rotating (600 lbs. cap.) - Steel
- Rotating Quick Attached Aluminum - Main Boom Only

Operator Aids



4-Function radio remote crane control system

Tool Box & Bulkhead

24 in. L x 18 in. W x 18 in. H - Steel (610 mm L x 457 mm W x 457 mm H)

48 in. L x 24 in. W x 24 in. H - Aluminum (1219 mm L x 610 mm W x 610 mm H)

Bulkhead: 24 in. (610 mm)

Manitex



CM350

35-ton (32 mt) TELESCOPIC CRANE
CM350 SERIES PRODUCT GUIDE

UPTIME is the Manitex commitment
to complete support of thousands
of units working every day.

UPTIME

MANITEX

3000 South Austin Avenue
Georgetown, Texas 78626

1-877-314-3390 www.Manitex.com