

Manitex



TC300.1

30-Ton (27,2 mt) TELESCOPIC CRANE
TC300 SERIES PRODUCT GUIDE

CONTENTS

Crane Features	4
Chassis Data	5
Outrigger Extension, Sub Frame, Electrical System	6
Intermediate Spread	6
Fully Retracted Spread	6
Area of Operation, Reeving Diagram.....	7
30112S Load Chart: Main Boom	8
30112S Boom Range Diagram	9
30112S Load Chart: Main Boom & Jib	10
30112S Mid-Span Outrigger Boom Diagram	11
30112S Load Chart: Retracted Outrigger Main Boom & Jib	12
30112S Fully Retracted Outrigger Range Diagram.....	13
Technical Descriptions	14
Options	15

This document is non-contractual. This document is supplied for reference use only. We are constantly making improvements to our products and reserve the right that specification, equipment, and prices are all subject to change without notice or obligation.

The photographs, and /or images in this document are for illustrative purposes only and may include optional equipment and accessories and may not include all standard equipment. Refer to the appropriate Operator’s Manual and Load Charts for instructions on the proper use of this equipment to determine allowable crane lifting capacities, assembly and operating procedures. Failure to follow the appropriate operator’s manual or load chart(s) when using our equipment or to otherwise act irresponsibly may result in serious injury or death.



















The only warranty applicable to our equipment is the standard written warranty applicable to the particular product and sale. Manitex makes no other warranty, expressed or implied. Products and services listed may be trademarks, service marks or trade-names of Manitex International and /or its subsidiaries in the USA and other countries.

















All rights are reserved. Manitex® is a registered trademark of Manitex International, Inc. in the USA and many other countries.

Copyright 2013 Manitex Inc. Manitex Inc, Georgetown Texas, 78626



KEY

	Operator aids
	Cab
	Heating / Air conditioning
	Controls
	Hoist speed
	1 - Main hoist 2 - Auxiliary winch 3 - Recovery winch
	Rope length
	Rope - standard/optional
	Rope diameter
	Permissible line pull
	Maximum line pull
	Slewing / Allowable slewing range
	Slewing gears
	Slewing brake
	Outriggers / Lifting on outriggers
	2-Person man basket
	Counterweight
	Radio remote control

	Hook block
	Distance from hook to head sheave pin
	Hook and ball
	Hydraulics
	Boom elevation angle
	Max. boom length with extension
	Boom with extension retracted
	Boom angle
	Telescoping mode
	Working radius
	Boom length
	Hydraulic actuated boom
	Full power mechanical synchronized
	Boom head / Hook block dimension
	Main boom with auxiliary head
	Tip height



THE TC300.1 SERIES TELESCOPIC CRANES

Versatile. Affordable. User friendly.

The TC300.1 series telescopic cranes are built to meet the wide-ranging needs of owner operators who may use it for residential construction one day and Steel erection the next. No matter what the task, the 30-ton line of telescopic crane is designed to get you to the job and on the job quickly.

- Travel to and between job sites at highway speed on a commercial chassis
- ROC (Rock Solid Outrigger Control)
- Allows for quick set up with remote outrigger controls
- Operate comfortably and confidently in the comfortable reclining cab

Other features include:

- 30-ton capacity @ 5 ft. radius
- 4 section fully proportional boom
- Optional telescopic jib
- 168 ft (51,2) maximum tip height
- Reclining Cab
- Out-and-down outriggers

OUT & DOWN OUTRIGGER

Four Out & Down Outriggers with Audible Outrigger Motion Alarm sounds as outriggers are being deployed and indicator lights verify when they are fully extended on 22" removable aluminum pads.

TWO-SPEED PLANETARY HOIST

Increase productivity and minimize downtime. The two-speed planetary hoist lets you change line speed on the fly and minimize rope stacking with grooved drum and mechanical drum flanges.

LOAD MOMENT INDICATOR

The Load-moment indicator sounds a warning or shuts down the machine when lift limitations are about to be exceeded.



Operator cab reclines from 0° to 20° for a comfortable, clear view of the load.

INCREASE PROFITABILITY

The versatile TC300.1 series is designed to help both owners and operators make the most of their investment.

- Minimize maintenance costs with long lasting, self-lubricating boom slider pads and sealed, multi-disc wet brakes on the hoist and swing system.
- Travel at highway speeds - no permits required.
- Quick setup time with standard ROC (Rock Solid Outrigger Control) outriggers and quick reeve boom nose.



TC300.1 SERIES CHASSIS DATA

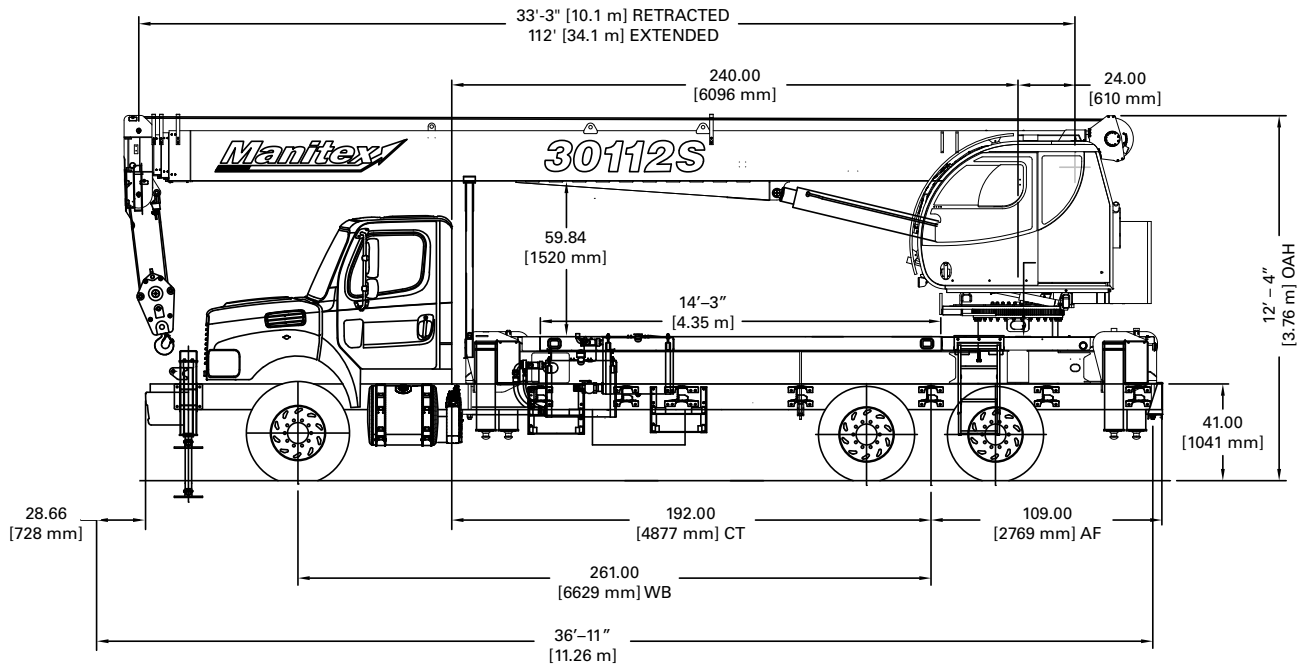

CHASSIS DATA

	30112S
Wheel Base (WB)	261 in. (6,629 mm)
Cab to Tandem (CT)	192 in. (4,877 mm)
Frame section modulus at 180° area of operation*	22.0 in ³ , 120,000 psi, 758,422 kPa
Cab to End of Frame (EOF)	301 in. (7,646 mm)
Nominal Frame Width	34 in. (864 mm)

* Frame selection modulus at 360° area of operation requires front bumper stabilizer.

TRUCK AXLE RATINGS AND MINIMUM WEIGHTS

	30112S
Front axle (GW)	20,000 lb. (9,790 kg)
Rear axle	40,000 lb. (19,580 kg)
Min. truck axle W - Front**	8,300 lb. (3,765 kg)
Min. truck axle W - Rear**	8,500 lb. (3,856 kg)

** Minimum chassis weight is required to meet 85% stability requirements. Chassis data is general - not for engineering. Some dimensions depend on truck selection.

CRANE WEIGHT

	30112S
Crane Dry Weight	26,300 lbs (11929 kg)
Flatbed 14.25 ft	1,200 lb. (544 kg)
Tele Fixed	1220 lb. (553 kg)

Data published herein is intended as a guide only. Crane operation is subject to machine specific load charts and information.

OUTRIGGER EXTENSION

OUTRIGGERS

Full Extension

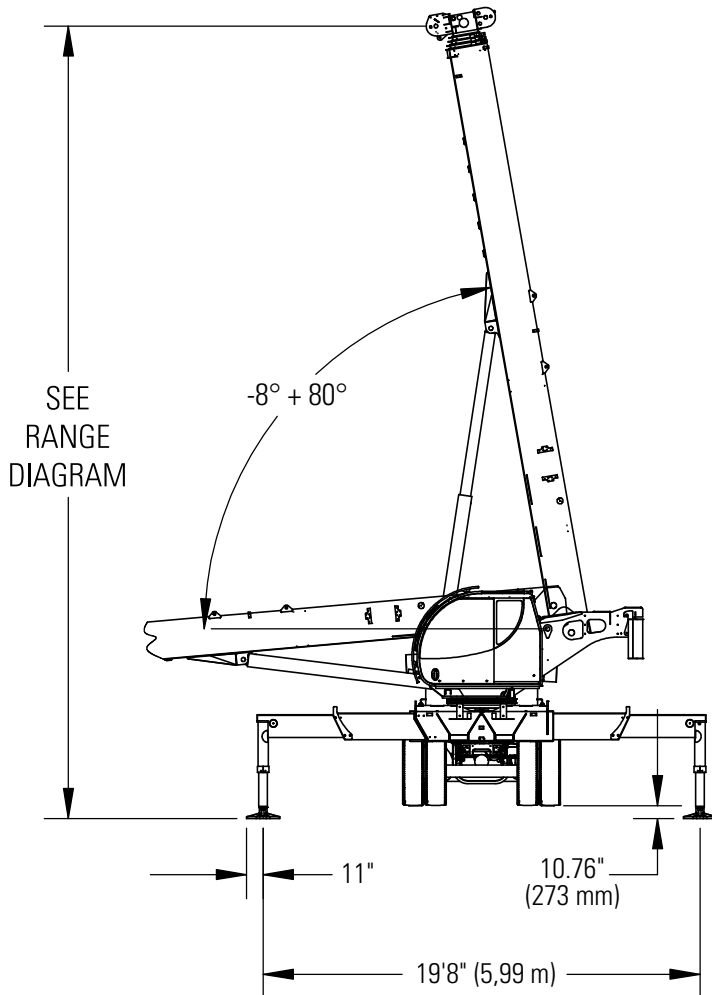

Intermediate Spread

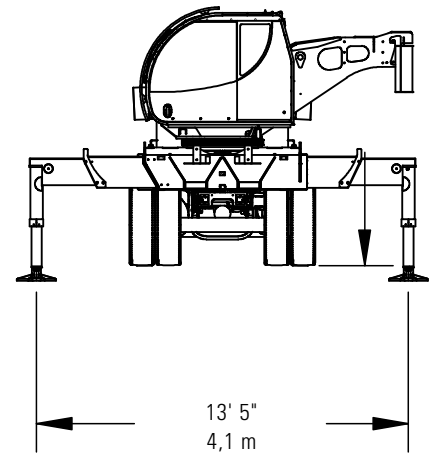

Fully Retracted Spread

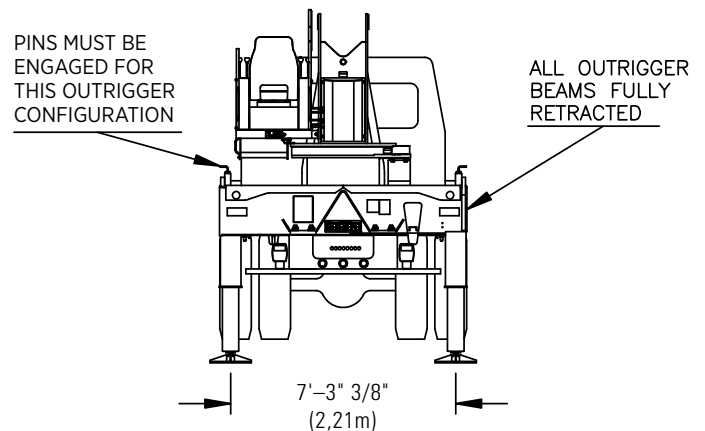

SUB FRAME

- Integral sub-frame and outriggers are mounted to chassis by threaded rods and clamp plates
- Sub-frame: Torsion resistant, rigid 4-plate design mounted under crane full length of truck frame
- Rear under-ride protection: Standard on factory mounted cranes

ELECTRICAL SYSTEM

- State-of-the-art, weather-resistant components throughout
- Hermetically sealed enclosure includes power in relays and circuit status LEDs

Data published herein is intended as a guide only. Crane operation is subject to machine specific load charts and information.

AREA OF OPERATION

Standard 360 degree area of operation.

Optional Front Stabilizer available.

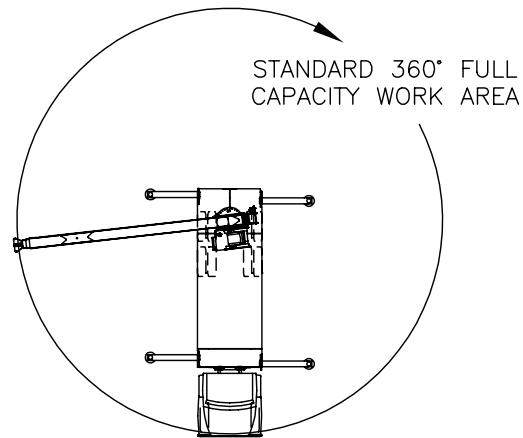

Deductions from rated loads for load handling devices supplied by Manitex

Auxiliary block	50 lbs. (22.7 kg)
Overhaul ball	See overhaul ball mfgr. nameplate
Load blocks	See load block mfgr. nameplate
Swing around jib (stowed)	See load chart

WARNING: Lifting off the main boom point while the jib is erected is not intended nor approved.

REEVING DIAGRAM

ALLOWABLE LINE PULL							WARNING
1 PART LINE	2 PART LINE	3 PART LINE	4 PART LINE	5 PART LINE	6 PART LINE	7 PART LINE	
8500 LBS	17000 LBS	25500 LBS	34000 LBS	42500 LBS	51000 LBS	60000 LBS	
7700 LBS	15400 LBS	23100 LBS	30800 LBS	38500 LBS	46200 LBS	53900 LBS	

ANTI-TWO-BLOCK SYSTEM MUST BE IN GOOD OPERATING CONDITION BEFORE OPERATING CRANE.

REFER TO THE OWNER'S MANUAL.

KEEP AT LEAST 3 WRAPS OF LOAD LINE ON THE DRUM AT ALL TIMES.

9/16" 6X25 IWRC (3.5:1 SF) - 30000 LBS MIN BREAKING STRENGTH

9/16" ROT RESISTANT (5.0:1 SF) - 38500 LBS MIN BREAKING STRENGTH

Data published herein is intended as a guide only. Crane operation is subject to machine specific load charts and information.

30112S LOAD CHART: Main Boom & Jib

Lifting Capacities 4 section Boom 112 ft.



Fully Extended Outriggers

MAIN BOOM RATED LOADS										JIB LOAD CAPACITIES							
LMI CODE 1										LMI CODE 2		LMI CODE 3		LMI CODE 4			
Load radius ∠°	33.25 ft.		55 ft. (A)		74 ft. (B)		93 ft. (C)		112 ft. (D)		Load radius ∠°	26 ft. Fixed Jib		26 ft. Tele. Jib		46 ft. Tele. Jib	
	(deg)	Lifting Capacity (lbs.)	(deg)	Lifting Capacity (lbs.)	(deg)	Lifting Capacity (lbs.)	(deg)	Lifting Capacity (lbs.)	(deg)	Lifting Capacity (lbs.)		(deg)	Lifting Capacity (lbs.)	(deg)	Lifting Capacity (lbs.)	(deg)	Lifting Capacity (lbs.)
5	80	60,000									5						
8	75	43,830									8						
10	71.5	37,330	79.5	25,000							10						
12	68	32,640	77.5	25,000							12						
15	62	27,600	74.5	24,610	79.5	22,120					15						
20	51.5	21,850	69	19,320	75.5	18,080	79.5	13,300			20						
25	38.5	16,630	63	15,930	71.5	14,750	76.5	11,900	79.5	8,000	25						
30	18.5	12,710	57	13,250	67.5	12,440	73.5	10,550	77	8,000	30	80	4,500	80	4,300		
35			50	10,540	63	10,720	70	9,330	74.5	7,290	35	78	4,500	78	4,300	79.5	2,700
40			42.5	8,350	58.5	8,570	67	8,500	72	6,600	40	76.5	4,500	76.5	4,300	78	2,700
45			33.5	6,630	53.5	6,850	63	6,960	69.5	5,970	45	74.5	4,300	74.5	4,030	76.5	2,700
50			21.5	5,330	48	5,560	59.5	5,670	66.5	5,390	50	72.5	4,000	72.5	3,720	75	2,700
55					42.5	4,550	55.5	4,660	63.5	4,730	55	70.5	3,700	70.5	3,420	73.5	2,700
60					36	3,740	51.5	3,860	60.5	3,920	60	68	3,420	68	3,140	72	2,700
65					27.5	3,070	47	3,190	57	3,260	65	66	3,130	66	2,800	70	2,580
70					16	2,510	42.5	2,640	54	2,710	70	63.5	2,790	63.5	2,440	68	2,390
75							37	2,170	50.5	2,240	75	61	2,350	61	2,050	66.5	2,220
80							31	1,770	46.5	1,840	80	58	1,940	58	1,650	64.5	2,020
85							23.5	1,410	42.5	1,490	85	55.5	1,590	55.5	1,300	62	1,770
90							11	1,100	38.5	1,180	90	52.5	1,290	52.5	990	59.5	1,460
95									33.5	910	95	49.5	1,020	49.5	720	57	1,190
100									28	670	100	46.5	780	46.5	480	54.5	940
105											105					52	730
110											110					49.5	530
	510 lbs.		310 lbs.		230 lbs.		190 lbs.		160 lbs.		DEDUCTIONS FOR STOWED FIXED JIB						
	770 lbs.		470 lbs.		350 lbs.		280 lbs.		230 lbs.		DEDUCTIONS FOR STOWED TELESCOPIC JIB						

NOTES:

- Loads based on crane with outriggers and with tires off the ground
- All "on outriggers" loads are based on 85% tipping
- Loads above heavy line are based on structural rating
- Loads below heavy line are based on tipping rating

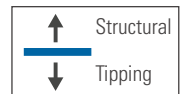

Data published herein is intended as a guide only. Crane operation is subject to machine specific load charts and information.



30112S BOOM DIAGRAM

RANGE DIAGRAM - FULLY EXTENDED OUTRIGGER CONFIGURATION -

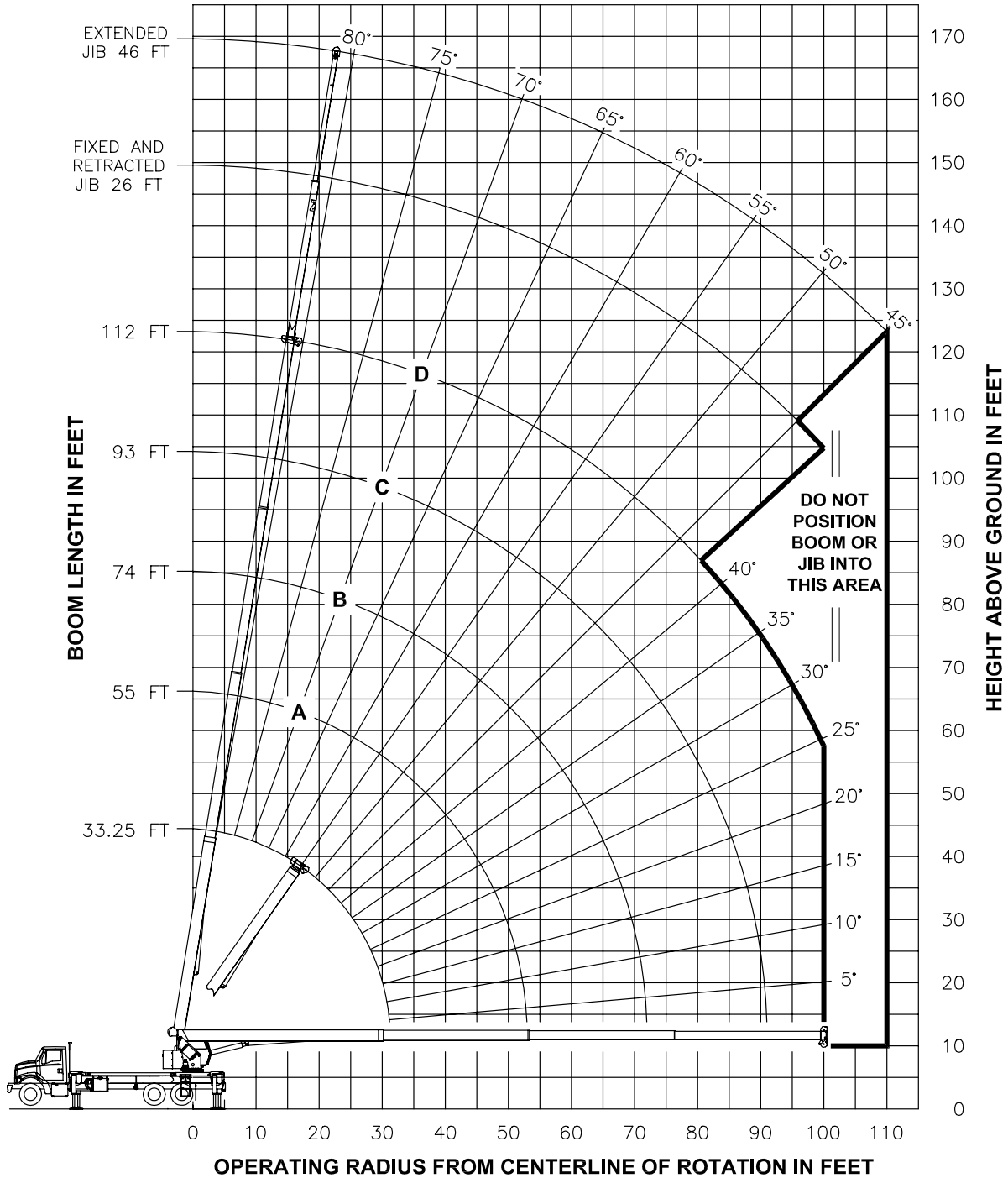

Data published herein is intended as a guide only. Crane operation is subject to machine specific load charts and information.

30112S LOAD CHART: Main Boom & Jib

Mid Extend Outriggers



MAIN BOOM RATED LOADS											JIB LOAD CAPACITIES						
LMI CODE 4											LMI CODE 34		LMI CODE 19		LMI CODE 22		
Load radius ∠°	33.25 ft.		55 ft. (A)		74 ft. (B)		93 ft. (C)		112 ft. (D)		Load radius ∠°	26 ft. Fixed Jib		26 ft. Tele. Jib		46 ft. Tele. Jib	
	(deg)	Lifting Capacity (lbs.)	(deg)	Lifting Capacity (lbs.)	(deg)	Lifting Capacity (lbs.)	(deg)	Lifting Capacity (lbs.)	(deg)	Lifting Capacity (lbs.)		(deg)	Lifting Capacity (lbs.)	(deg)	Lifting Capacity (lbs.)	(deg)	Lifting Capacity (lbs.)
5	80	60,000									5						
8	75	43,830									8						
10	71.5	37,330	79.5	25,000							10						
12	68	32,640	77.5	25,000							12						
15	62	24,850	74.5	24,610	79.5	22,120					15						
20	51.5	13,890	69	14,520	75.5	14,760	79.5	13,300			20						
25	38.5	8,910	63	9,510	71.5	9,720	76.5	9,850	79.5	8,000	25						
30	18.5	6,030	57	6,650	67.5	6,850	73.5	6,960	77	7,040	30	80	4,500	80	4,300		
35			50	4,790	63	4,990	70	5,100	74.5	5,170	35	78	4,500	78	4,300	79.5	2,700
40			42.5	3,490	58.5	3,690	67	3,800	72	3,860	40	76.5	3,950	76.5	3,640	78	2,700
45			33.5	2,530	53.5	2,730	63	2,830	69.5	2,900	45	74.5	2,980	74.5	2,670	76.5	2,700
50			21.5	1,770	48	1,990	59.5	2,090	66.5	2,160	50	72.5	2,230	72.5	1,920	75	2,440
55					42.5	1,400	55.5	1,500	63.5	1,570	55	70.5	1,640	70.5	1,330	73.5	1,830
60					36	920	51.5	1,020	60.5	1,090	60	68	1,160	68	850	72	1,350
65											65					70	940
70											70						
	510 lbs.		310 lbs.		230 lbs.		190 lbs.		160 lbs.		DEDUCTIONS FOR STOWED FIXED JIB						
	770 lbs.		470 lbs.		350 lbs.		280 lbs.		230 lbs.		DEDUCTIONS FOR STOWED TELESCOPIC JIB						

NOTES:

- Loads based on crane with outriggers off the ground
- All "on outriggers" loads are based on 85% tipping
- Loads above heavy line are based on structural rating
- Loads below heavy line are based on tipping rating

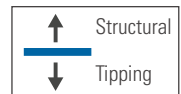

30112S BOOM DIAGRAM



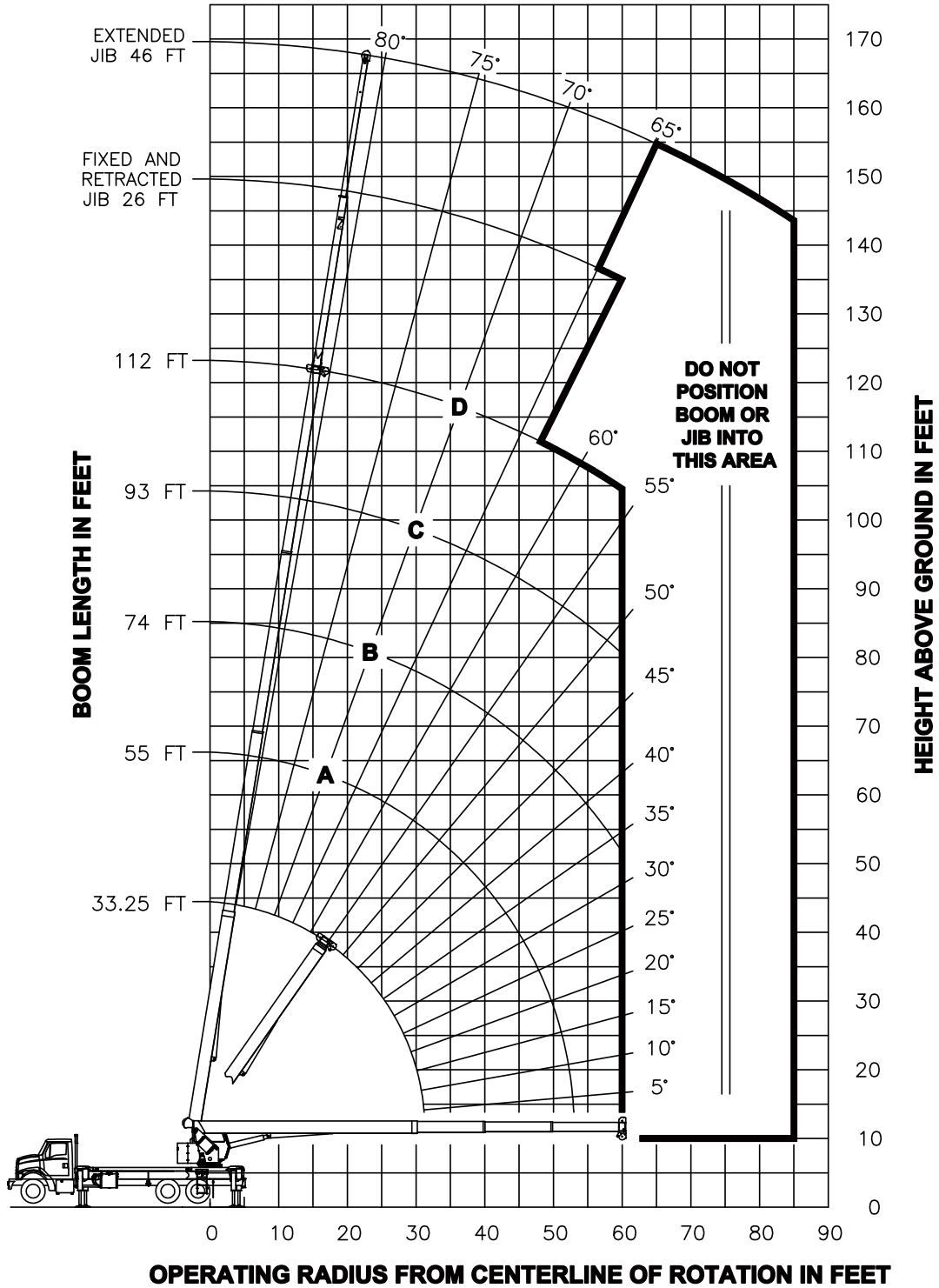

RANGE DIAGRAM - MID EXTEND OUTRIGGER CONFIGURATION -



30112S LOAD CHART: Main Boom & Jib

Full Retracted Outriggers

 7' 3/8" (2,21 m)

MAIN BOOM RATED LOADS											
LMI CODE 5											
Load radius ∠°	33.25 ft.		55 ft. (A)		74 ft. (B)		93 ft. (C)		112 ft. (D)		
	 (deg)	Lifting Capacity (lbs.)	 (deg)	Lifting Capacity (lbs.)	 (deg)	Lifting Capacity (lbs.)	 (deg)	Lifting Capacity (lbs.)	 (deg)	Lifting Capacity (lbs.)	
5	80	60,000									
8	75	27,790									
10	71.5	17,750	79.5	18,400							
12	68	12,510	77.5	13,100							
15	62	8,100	74.5	8,640	79.5	8,850					
20	51.5	4,330	69	4,850	75.5	5,030	79.5	5,140			
25	38.5	2,310	63	2,820	71.5	3,000	76.5	3,100	79.5	3,170	
30	18.5	1,020	57	1,560	67.5	1,740	73.5	1,840	77	1,900	
35			50	700	63	880	70	980	74.5	1,040	
	510 lbs.		310 lbs.		230 lbs.		190 lbs.		160 lbs.		DEDUCTIONS FOR STOWED FIXED JIB
	770 lbs.		470 lbs.		350 lbs.		280 lbs.		230 lbs.		DEDUCTIONS FOR STOWED TELESCOPIC JIB

NO JIBS ARE TO BE ERECTED IN THIS OUTRIGGER CONFIGURATION

NOTES:

- Loads based on crane with outriggers off the ground
- All "on outriggers" loads are based on 85% tipping
- Loads above heavy line are based on structural rating
- Loads below heavy line are based on tipping rating

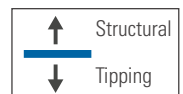

30112S BOOM DIAGRAM

RANGE DIAGRAM - FULLY RETRACTED OUTRIGGER CONFIGURATION -

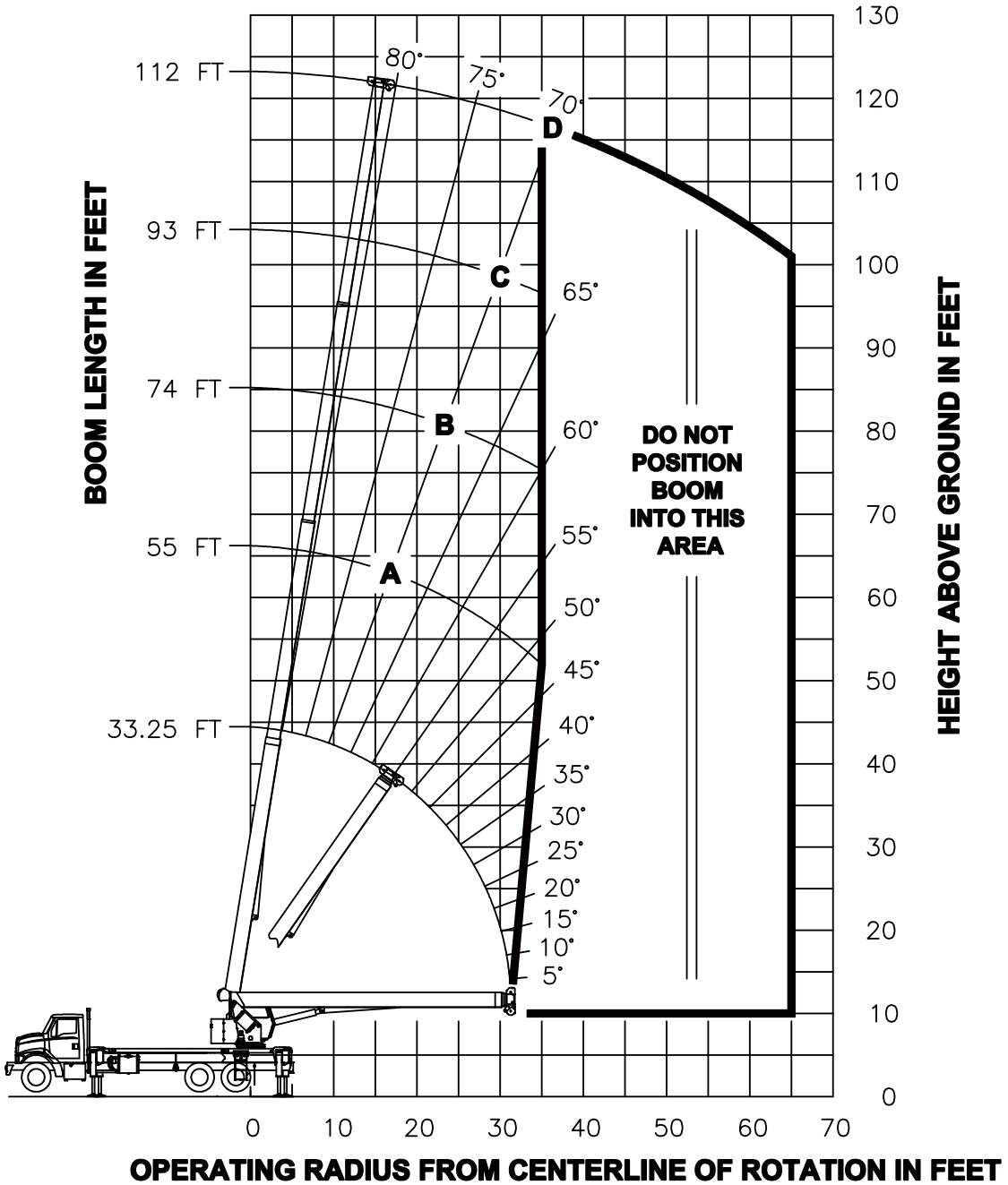

TECHNICAL DESCRIPTIONS

Boom



Boom lengths: Proportional boom

- 4-section 112 ft. (34,1 m)
- 4-Sheave quick reeve boom point
 - 1 Upper idler sheave
 - 3 Load sheaves

Self lubricating slider pads with Teflen inserts



Max. tip height 30112S: 122 ft. (37.2 m)



Boom angle (min/max): -8° / 80°

Rotation



Ball-bearing swing circle with external gear
Double-reduction planetary gearbox driven by hydraulic motor



Slewing brake: Spring-applied pressure released automatic brake



Slewing speed: 1.5 - 2 rpm. (nominal)
Boom rotation: 360° continuous

Outriggers



Outriggers: Out-and-down style
FBS - Front Bumper Stabilizer (optional)
Outrigger monitoring system (for verification only)
Outrigger motion alarm
Full extension

- Center to center: 19 ft 8 in (5,91 m)

 Fully retracted

- Center to center: 7 ft 3/8 in (2,1 m)

 ROC Rock Sold Radio Remote Outrigger Control

Operator aids



Anti Two Block system
Outrigger motion alarm
Boom angle indicator
Bubble Level
LMI - Load Moment Indicator

Hoist, Rope and Hook



Maximum theoretical line speed:
300 fpm (91 mpm)



Maximum theoretical bottom-layer line pull rating:
11,500 lb (5,216 kg)



Main winch cable diameter: 9/16" (14,3 mm).
Rotation Resistant Rope



Line length: 335 ft. (102,2m)



Main winch motor: Gear



Overhaul ball: 7T (6,4 mt) capacity hook with heavy-duty swivel and weight is provided for single line operation.

Hydraulics



8-bolt direct mounted PTO and SAE C output (factory mounted units only)

3 -section gear pump, SAE C input

Hydraulic reservoir capacity:
70 gal. (265 L)

- Suction stainer
- Ball Shutoff valve
- Magnetic drain plug

Return filter - 10 micron

Winch 32 GPM

Pump sections @ 2000 rpm with 100 psi

- Cover end pump: 11.7 gpm (44 LPM)

Boom Hoist/Telescopic 20 spm

Oil Cooler

Reclining Cab/Cab Controls



Standard features:

Curved glass, 0° to 20° cab tilt, Sliding door, heated cloth seat, 8 seat adjustments, lumbar support, reclining and adjustable head rest, sliding windows, rear pop out window, top hinged hatch, standard diesel fired heater, retractable sun screen, 12 volt DC outlet, E-coated cab



Controls:

four (4) single axis pilot oil controls, CANBUS communication, J1939 truck engine communication capability, electronic hand and foot throttle, Hirschmann/PAT iScout D3 LMI system

OPTIONS

Boom

Jibs

30112S

- 1-section Fixed Jib 26' (7,9 m)
- 2-section Telescopic Jib 26' - 46' (7,9m-14m)

Max. Tip Height with Extension



30112S

- Max tip height with extension: 168' (51.2 m)
- Max tip height with extension retracted: 146' 6" (44.7 m)

Bulkhead

24 in. (607 mm) bulkhead

Tool Boxes & Flatbed

Tool Boxes

- 24 in. L x 18 in. W x 18 in. H (610 mm L x 457 mm W x 457 mm H)
- 48 in. L x 24 in. W x 24 in. H (1,219 mm L x 610 mm W x 610 mm H)

Flatbeds

- 14' (4,3 m) Steel Flatbed
- 14' (4,3 m) Wood Flatbed

Hydraulics



Hose reel – boom mounted.
Front Bumper Stabilizer (FBS)
Free Swing - No Free Swing Control Option

Cab



Video camera (1 or 2)
Cab weather band radio system

Radio Remote Control



- Radio Remote Control with Joysticks (900 MHz or 433 MHz)
- Radio Remote Control with Paddles (900 MHz or 300 MHz)

2-person Basket



Consult Manitex for specific application and rating

- 2-person Steel Gravity Levelled Basket with Friction Brake
- 2-person Aluminum Quick Attached Rotating Basket

Hoist and Hook



Auxiliary lower sheave block for 5-7 part lines
Load blocks 1, 2-4, 2-6 part lines

NOTES

Manitex



TC300.1

30-Ton (27,2 mt) TELESCOPIC CRANE
TC300 SERIES PRODUCT GUIDE

UPTIME

UPTIME is the Manitex commitment to complete support of thousands of units working every day.

MANITEX

3000 South Austin Avenue
Georgetown, Texas 78626

1-877-314-3390 | www.Manitex.com

MTX-TC300.1-PC-EN-V3-0217