



135 USt



217 ft



210 ft



299 ft

---

# There's nothing more on 4

---

## LTM 1120-4.1

Mobile crane  
Grue mobile

# LIEBHERR

Mobile and crawler cranes



# Technical data

## Caractéristiques technique

---

<b>Dimensions</b>	
Encombrement .....	3
<b>Mobile Crane</b>	
Grue mobile .....	4-5
<b>Equipment</b>	
Équipement .....	6-7
<b>Weights</b>	
Poids .....	8
<b>Working speeds</b>	
Vitesses .....	8
<b>VarioBallast Counterweight radius</b>	
Rayon de contrepoids .....	9
<b>Counterweight</b>	
Contrepoids .....	9
<b>On-road driving</b>	
Déplacement sur route .....	10
<b>Jobsite driving</b>	
Déplacement sur chantier .....	10
<b>Boom/jib combinations</b>	
Configurations de flèche .....	11
<b>T</b> .....	12-17
<b>TK/TNZK</b> .....	18-20
<b>TVK/TVNZK</b> .....	21-23
<b>TK</b> .....	24-25
<b>Equipment</b>	
Équipement .....	26-27
<b>Description of symbols</b>	
Explication des symboles .....	28
<b>Remarks</b>	
Remarques .....	29



# Dimensions

## Encombrement

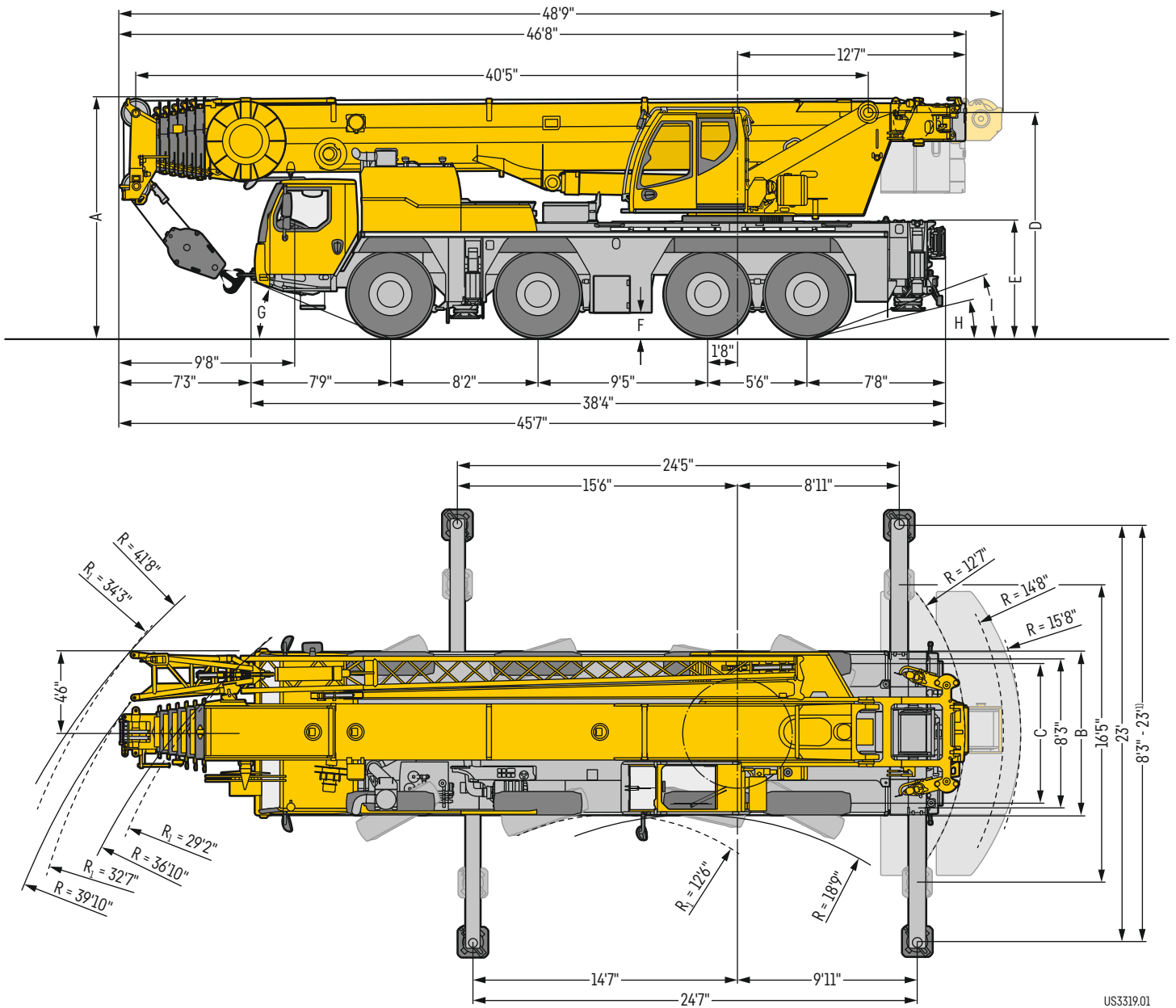

US3319.01

R<sub>1</sub> = All-wheel steering · Direction toutes roues

<sup>1)</sup> only with VarioBase® · seulement avec VarioBase®

### Dimensions · Encombrement

	A	A	B	C	D	E	F	G	H	I
		4"*								
445/95 R 25 (16.00 R 25)	13'1"	12'10"	9'	7'7"	12'4"	6'3"	1'3"	23°	13°	20°
525/80 R 25 (20.5 R 25)	13'1"	12'10"	9'6"	7'9"	12'4"	6'3"	1'3"	23°	13°	20°

\* lowered · abaissé

# LTM 1120-4.1

---



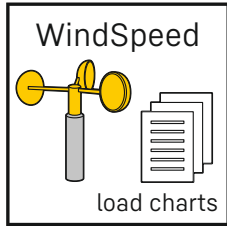

Increased flexibility and safety by using lifting capacity tables with different maximum wind speeds.

Une flexibilité et une sécurité accrues grâce aux tableaux de charge avec différentes vitesses de vent autorisées.

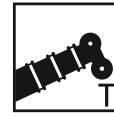

217 ft



35 ft – 62 ft

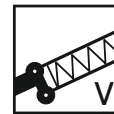

23 ft



9.5 ft

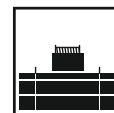

68,300 lb



330 kW (449 PS)

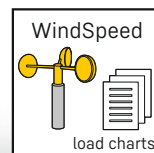
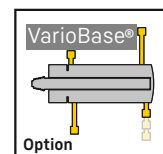
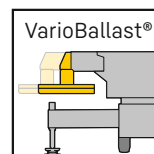

# Far away, yet very close

## Loin et pourtant si proche

Camera system for telescopic boom and equipment including colour monitor

- Ideal for working over difficult edges
- Helpful zoom function

Système de caméra pour flèche télescopique et équipement avec écran couleur

- Idéal pour travailler au-dessus d'arêtes gênantes
- Fonction zoom pratique

**optional**



# Constricted site? – VarioBase®!

## Le chantier est étroit ? – VarioBase® !

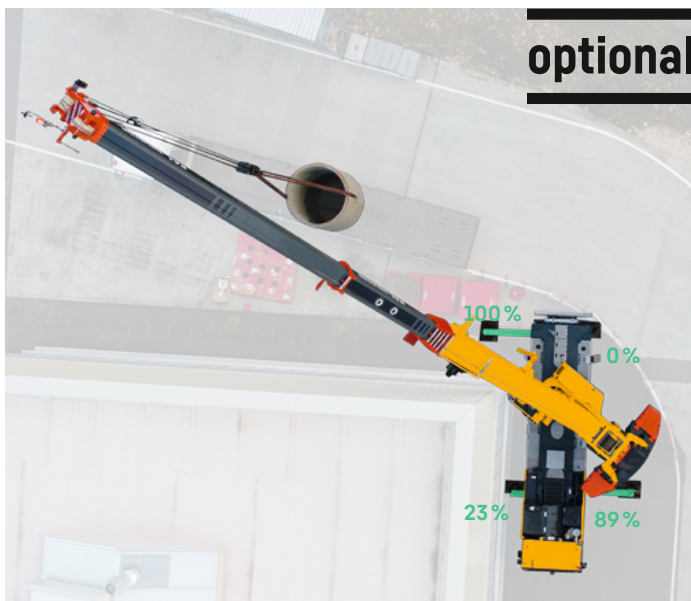

- Variable extension of outriggers to any position
- Best possible lifting capacities using real-time calculation
- Greater economy by reducing counter weights

- Déploiement variable des longerons coulissants quelle que soit la position
- Capacités de charge optimales grâce au calcul en temps réel
- Rentabilité supérieure grâce à l'économie de contrepoids



# VarioBallast® – For greater flexibility every day

## Une plus grande flexibilité au quotidien



- 12.6 ft radius for smaller footprint
- Rayon de 12.6 ft nécessitant moins de place



- 15.6 ft radius for higher lifting capacities
- Rayon de 15.6 ft pour des capacités de charge supérieures



- Simple mechanical adjustment
- Réglage mécanique simple

## Practical work equipment

## Équipement de travail pratique





- Mechanically or hydraulically adjustable double swing-away jib
- Greater working range and working over difficult edges
- Interchangeable with many of the crane models
- Double fléchette pliante réglable mécaniquement et hydrauliquement
- Grande zone de travail et travail au-dessus d'arêtes gênantes
- Échangeable avec de nombreux autres types de grue



# Weights

## Poids









### Hook block - Moufles à crochet

			
181,200 lb	7	12	2,750 lb
167,300 lb	5	10	2,000 lb
109,570 lb	3	7	1,550 lb
48,500 lb	1	3	1,000 lb
16,300 lb	-	1	550 lb

# Working speeds









## Vitesses

### Crane carrier - Châssis porteur

	 min.	 max.	 %		
445/95 R 25 (16.00 R 25)	0.3	53	56,5 %		12 / R2
525/80 R 25 (20.5 R 25)	0.3	53	56,5 %		4 / R2

Theoretical gradeability - Aptitude théorique en pente

### Crane superstructure - Partie tournante

			 F
 0 - 374 ft/min single line - au brin simple	0.74°	820 ft	16,635 lb
 0 - 374 ft/min single line - au brin simple	0.74°	820 ft	16,635 lb
 0 - 1.8 rpm			
 approx. 63 seconds to reach 83° boom angle env. 63 s jusqu'à 83°			
 approx. 475 seconds for boom extension from 40 ft - 217 ft env. 475 s pour passer de 40 ft - 217 ft			



# VarioBallast

## Counterweight radius

### Rayon de contrepoids

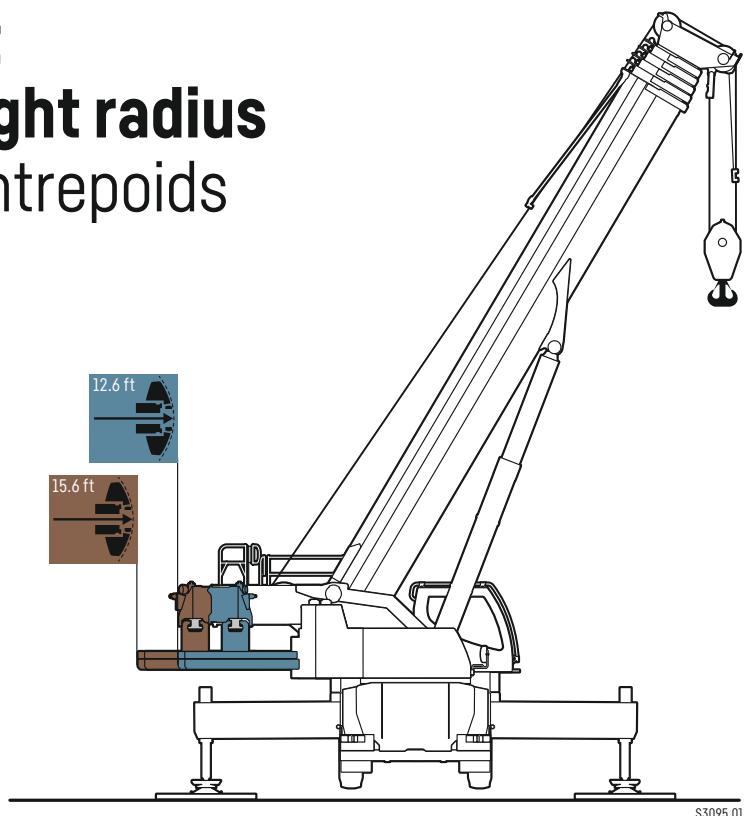

S3095.01

# Counterweight

## Contrepoids

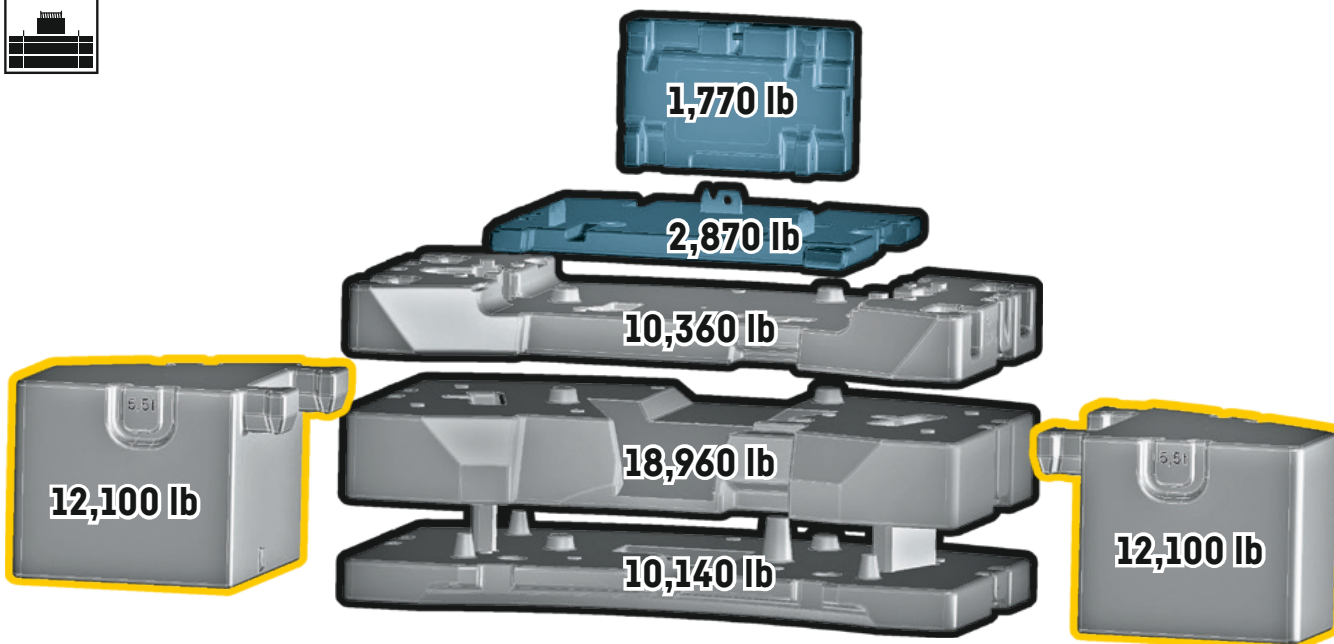
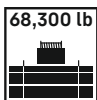

**26,400 lb axle load**  
26,400 lb de charge par essieu



**Technically transportable**  
Transport techniquement simplifié



**Additional counterweight**  
Contrepoids additionnel

# On-road driving

## Déplacement sur route

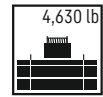
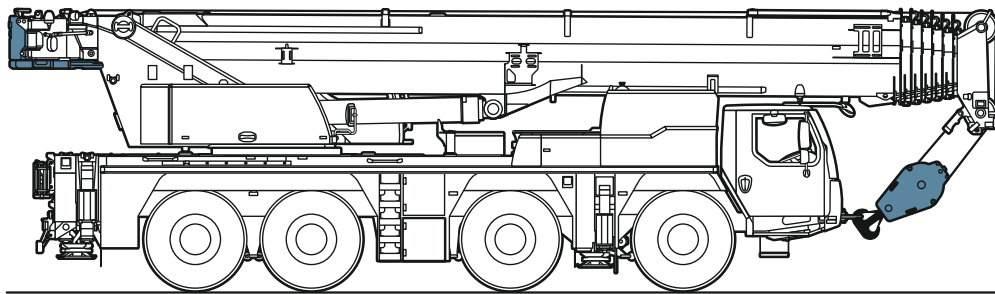

≤ 105,800 lb

≤ 26,400 lb ≤ 26,400 lb ≤ 26,400 lb ≤ 26,400 lb

# Jobsite driving

## Déplacement sur chantier

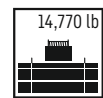
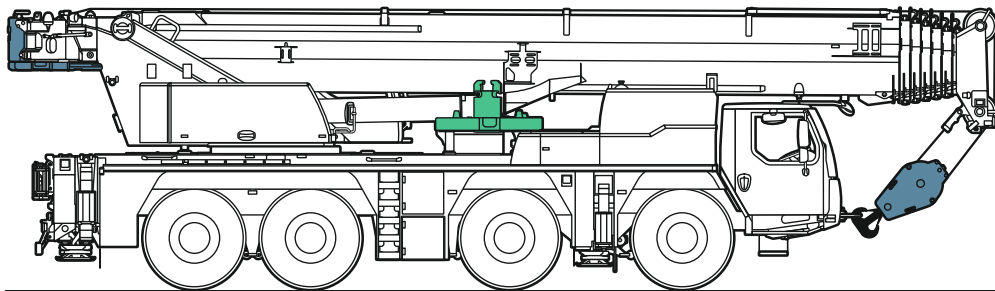

≤ 117,000 lb

≤ 28,700 lb ≤ 28,700 lb ≤ 29,800 lb ≤ 29,800 lb

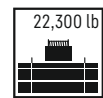
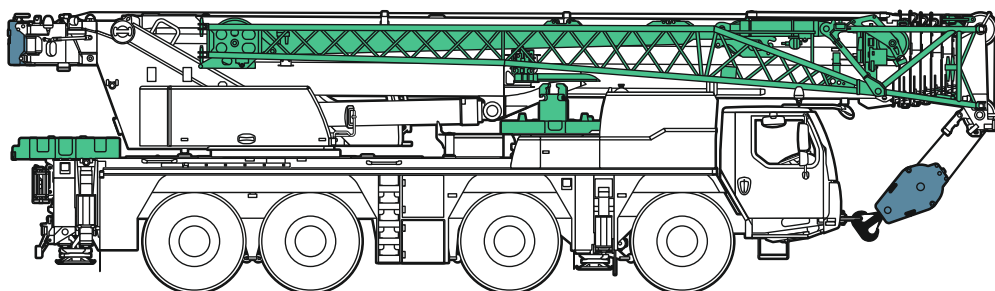

≤ 127,900 lb

≤ 32,000 lb ≤ 32,000 lb ≤ 32,000 lb ≤ 32,000 lb

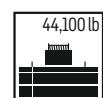
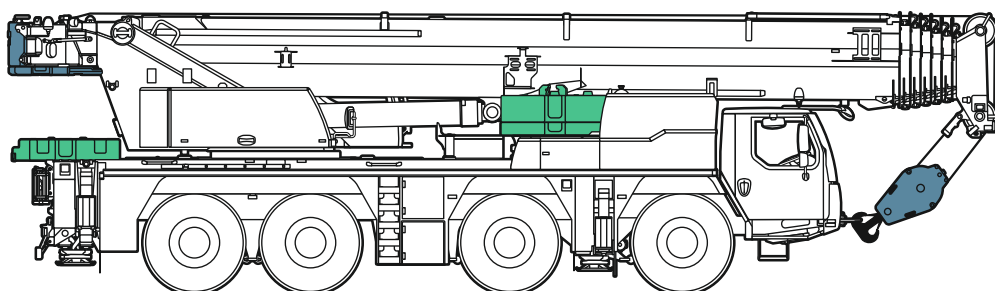

≤ 145,600 lb

≤ 36,400 lb ≤ 36,400 lb ≤ 36,400 lb ≤ 36,400 lb

US3342.02

# Boom/jib combinations

## Configurations de flèche

**T** Telescopic boom - Flèche télescopique

**K/NZK** Mechanically/hydraulically adjustable folding jib - Pointe pliante réglable mécaniquement/hydrauliquement

**V** Telescopic boom extension - Rallonge de flèche télescopique

**K** Assembly jib - Fléchette de montage





# Lifting heights

## Hauteurs de levage

T

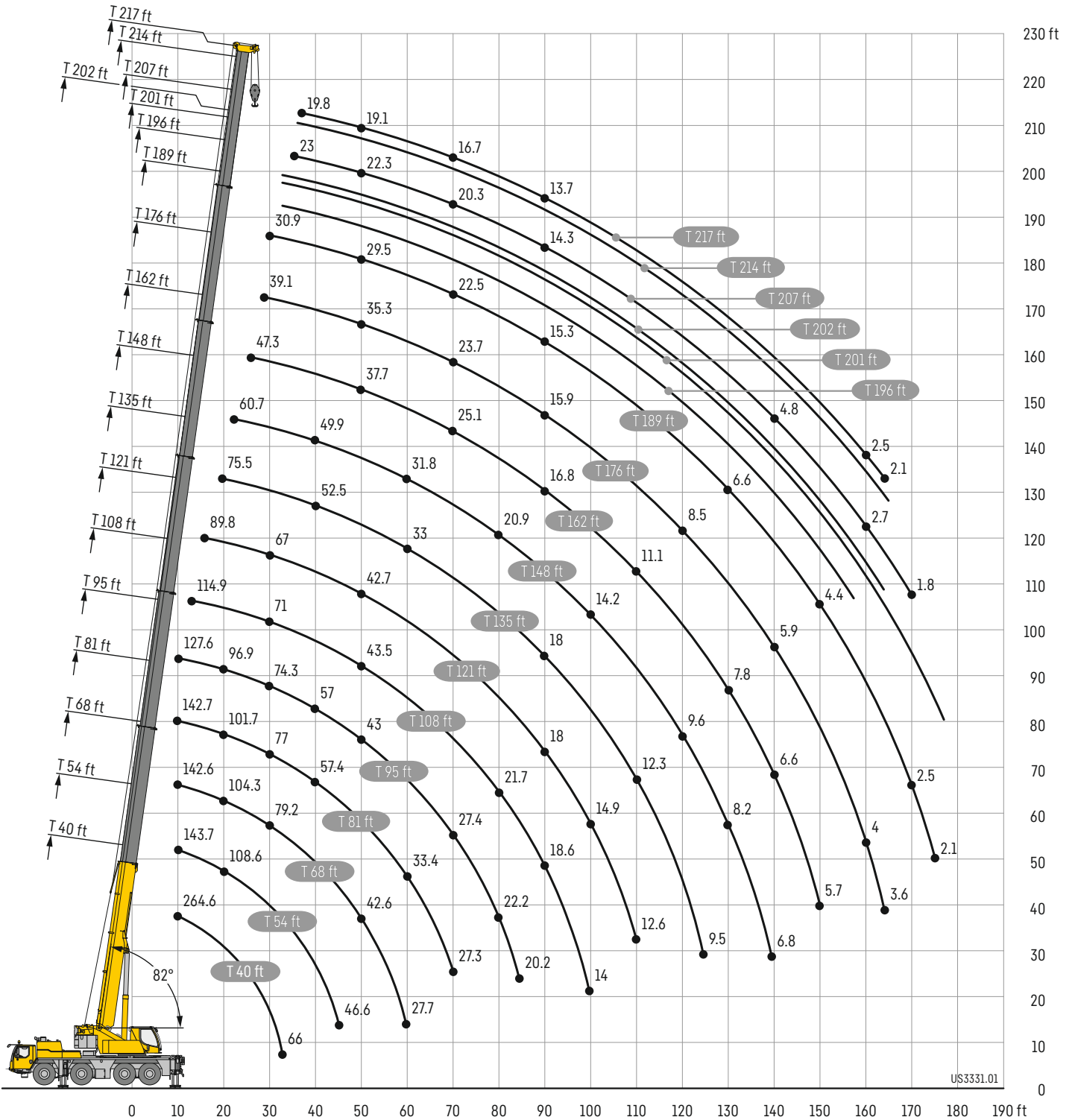

US3331.01

# Lifting capacities

## Forces de levage

T

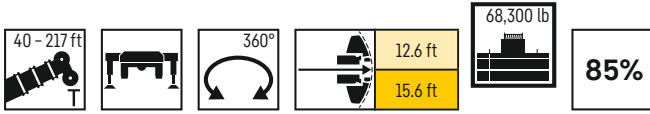

	40 ft		54 ft	68 ft	81 ft	95 ft	108 ft	121 ft	135 ft	148 ft	162 ft	176 ft	189 ft	196 ft	201 ft	202 ft	207 ft	214 ft	217 ft		
	*																				
10	264.6	153.2	143.7	142.6	142.7	127.6															10
11	202.1	153.2	143.7	142.6	142.7	138.5															11
12	162.1	151.4	143.7	142.6	142.5	137.2															12
13	155.1	147.2	143.7	141.1	135.7	129.8	114.9														13
14	147.1	140.6	138.7	133.7	128.7	123.2	114.5														14
15	139.2	134.6	131.4	127.5	123.4	117.7	109.6	89.8													15
16	132.4	128.7	125.5	121.3	116.9	110.8	104.4	92.8													16
17	126.9	123.3	121.2	116.4	112.6	106.3	101.3	92.6													17
18	122.1	118.2	116.7	112	108.6	102.4	98.6	91.7													18
19	117.6	113.4	112.6	108	104.7	99.7	95.7	89.7	75.5												19
20	113.3	109	108.6	104.3	101.7	96.9	92.8	87.9	75.3												20
22	105.3	101	101.9	98.9	95.3	90.9	87.3	82.7	74.9	60.7											22
24	98	94	95.5	92.9	89.3	87.7	83.1	78.3	73.4	60.6	47.3										24
26	90.9	87.7	89.5	88.3	85.3	83	78.6	74.2	70.4	60.3	48.9										26
28	83.8	81.6	83.9	83.9	81.3	78.4	74.6	70.5	67.5	60	48.8	39.1									28
30	76.1	75.4	77.9	79.2	77	74.3	71	67	65.1	59.5	48.7	39.1	30.9								30
32	66	66	72.4	73.8	73	70.5	67.7	63.8	62.1	58.3	48.5	39	30.9	26.7	23.2						32
34			67.6	68.9	69.2	67.2	64.5	61.6	59.3	56.1	48.2	38.9	30.9	26.6	23.1	24.8	23				34
36			63.3	64.6	64.9	63.9	61.5	59.6	56.8	53.8	47.9	38.8	30.9	26.3	23	24.8	23	20.3	19.8		36
38			59.4	60.7	61	60.7	58.7	57.7	54.4	52	47.3	38.5	30.7	26.1	22.8	24.7	22.9	20.2	19.7		38
40			55.6	57	57.4	57	55.9	55.1	52.5	49.9	46.4	38.2	30.6	25.8	22.6	24.6	22.8	20.1	19.6		40
45			46.6	49	49.3	49	49.4	48.7	46.4	44.2	41.7	37.2	30.1	24.9	22.2	24.3	22.6	19.9	19.4		45
50				42.6	42.9	43	43.5	42.7	40.6	39.2	37.7	35.3	29.5	23.9	21.6	23.9	22.3	19.6	19.1		50
55				37.4	37.7	38.8	38.3	37.5	36.6	35.3	33.9	32	28.6	22.9	21	23.5	21.9	19.2	18.7		55
60				27.7	33.4	34.4	34	33.2	33	31.8	30.4	29.1	27.4	21.9	20.3	22.9	21.4	18.7	18		60
65					30.4	30.7	30.2	29.5	30	28.8	27.9	26.4	24.8	20.9	19.5	22.3	20.9	18.2	17.4		65
70					27.3	27.4	26.9	26.5	26.6	26.2	25.1	23.7	22.5	19.8	18.8	21.1	20.3	17.7	16.7		70
75						24.6	24.1	24.6	23.8	23.4	22.5	22	21	18.6	18	19.5	19.4	17.1	16.1		75
80						22.2	21.7	22.1	21.4	20.9	20.7	20	19	16.9	17.2	17.5	17.5	16.4	15.4		80
85						20.2	19.9	19.9	19.2	18.9	18.7	17.8	17.1	15.2	16.4	15.8	15.8	15.5	14.6		85
90							18.6	18	18	17.3	16.8	15.9	15.3	13.5	15.2	14.2	14.3	14	13.7		90
95							16.9	16.4	16.3	15.7	15.1	14.2	13.6	11.8	13.6	12.7	12.8	12.6	12.4		95
100							14	14.9	14.8	14.2	13.6	12.8	12.2	10.4	12.2	11.2	11.3	11.2	11.1		100
105								13.6	13.5	12.8	12.3	11.5	10.9	9.2	10.9	9.9	10	10	9.8		105
110								12.6	12.3	11.6	11.1	10.3	9.7	8.2	9.7	8.9	9	8.9	8.8		110
115									11.2	10.5	10	9.3	8.8	7.4	8.8	8	8.1	8	7.9		115
120									10.3	9.6	9.1	8.5	8	6.6	8	7.2	7.3	7.3	7.1		120
125									9.5	8.9	8.4	7.8	7.3	5.9	7.3	6.5	6.6	6.6	6.4		125
130										8.2	7.8	7.1	6.6	5.2	6.6	5.9	6	5.9	5.8		130
135										7.6	7.2	6.5	6	4.6	6	5.3	5.4	5.3	5.2		135
140										6.8	6.6	5.9	5.4	3.9	5.5	4.7	4.8	4.7	4.6		140
145											6.1	5.4	4.9	3.3	5	4.1	4.3	4.2	4.1		145
150											5.7	5	4.4	2.7	4.5	3.6	3.8	3.7	3.6		150
155												4.5	3.9	2.2	4	3	3.2	3.2	3		155
160												4	3.4		3.5	2.5	2.7	2.7	2.5		160
165												3.6	2.9		3	2.1	2.2	2.2	2.1		165
170													2.5		2.6		1.8				170
175													2.1		2.2						175
180															1.8						180

\* ± 0° over rear - en arriere

t\_284\_001\_10051\_00\_000 - t\_284\_001\_15301\_00\_000 - t\_284\_10301\_00\_000

# Lifting capacities

## Forces de levage

T



	40 ft	54 ft	68 ft	81 ft	95 ft	108 ft	121 ft	135 ft	148 ft	162 ft	176 ft	189 ft	196 ft	201 ft	202 ft	207 ft	214 ft	217 ft	
10	153.2	143.7	142.6	142.7	127.6														10
11	153.2	143.7	142.6	142.7	138.5														11
12	150.8	143.7	142.6	142.5	137.2														12
13	145.5	143.7	141.1	135.7	129.8	114.9													13
14	138.5	138.4	133.7	128.7	123.2	114.5													14
15	132.2	131.4	127.5	123.4	117.7	109.6	89.8												15
16	126.4	125.5	121.3	116.9	110.8	104.4	92.8												16
17	121	121.2	116.4	112.6	106.3	101.3	92.6												17
18	116	116.6	112	108.6	102.4	98.6	91.7												18
19	111.3	112.1	108	104.7	99.7	95.7	89.7	75.5											19
20	106.9	107.6	104.3	101.7	96.9	92.8	87.9	75.3											20
22	97.4	99.3	98.7	95.3	90.9	87.3	82.6	74.9	60.7										22
24	88.5	90.5	91.3	89.3	87.7	82.6	77.8	72	60.6	47.3									24
26	81	83.5	84.8	83.8	80.4	75.4	70.7	67.7	60.3	48.9									26
28	73.8	76.7	78.2	77.5	73.3	68.9	67.3	63.2	58.8	48.8	39.1								28
30	67.5	70.3	71.8	70.9	67.4	64.6	62	58.6	55.4	48.7	39.1	30.9							30
32	62	64.8	66.2	65.2	62	60.9	57.4	54.2	51.5	47.2	39	30.9	26.7	23.2					32
34		59.9	61.4	60.2	57.4	56.6	53.3	51.2	48.3	44.7	38.9	30.9	26.6	23.1	24.8	23			34
36		55.3	56.9	56	54.7	52.7	49.7	47.8	45.4	43.1	38.8	30.9	26.3	23	24.8	23	20.3	19.8	36
38		50.6	52.5	52.2	51.6	49.3	46.9	44.7	43.1	40.8	37.5	30.7	26.1	22.8	24.7	22.9	20.2	19.7	38
40		46.4	48.3	48.6	48.4	46.1	44.1	42.8	40.6	38.6	36.1	30.6	25.8	22.6	24.6	22.8	20.1	19.6	40
45		38.2	40	41.5	41.5	39.7	38.2	37.2	35.9	33.9	32	29.9	24.9	22.2	24.3	22.6	19.9	19.4	45
50			33.8	35.2	35.4	34.5	34.3	32.7	31.4	29.9	28.6	26.4	23.9	21.6	23.9	22.3	19.6	19.1	50
55			28.9	30.3	30.4	30.4	30.3	28.7	27.7	26.9	25.2	23.9	21.4	21	22	21.5	19.2	18.7	55
60			25	26.4	26.5	27	26.5	26.2	24.9	23.7	22.2	21	18.6	20	19.2	19.1	18.4	18	60
65				23.1	23.4	23.5	23	23	22.1	21	19.6	18.6	16.2	17.9	16.8	16.8	16.3	16.1	65
70				20.4	20.4	20.6	20.3	20.1	19.4	18.6	17.4	16.4	14.1	15.9	14.8	14.8	14.4	14.1	70
75					18	18.2	17.8	17.6	16.9	16.3	15.4	14.5	12.2	14.1	13	13	12.7	12.4	75
80					15.9	16.1	15.7	15.6	14.9	14.3	13.4	12.7	10.6	12.5	11.4	11.4	11.2	10.9	80
85					14.2	14.3	13.9	13.7	13.1	12.5	11.6	10.9	9.2	10.9	9.9	10	9.8	9.6	85
90						12.7	12.3	12.2	11.5	10.9	10.1	9.4	7.9	9.4	8.6	8.7	8.6	8.4	90
95						11.4	11	10.8	10.1	9.6	8.9	8.3	6.8	8.3	7.5	7.6	7.5	7.4	95
100						10.3	9.7	9.6	9	8.6	7.9	7.4	5.8	7.4	6.6	6.7	6.6	6.4	100
105							8.8	8.7	8.1	7.7	7	6.5	4.8	6.5	5.7	5.8	5.7	5.5	105
110							8.1	7.9	7.4	6.9	6.2	5.7	4	5.8	4.9	5	4.9	4.7	110
115								7.2	6.7	6.2	5.5	5	3.2	5.1	4.1	4.3	4.1	3.9	115
120								6.6	6	5.6	4.9	4.4	2.5	4.4	3.4	3.6	3.4	3.2	120
125								6	5.5	5	4.3	3.8	1.8	3.8	2.8	2.9	2.8	2.6	125
130									4.9	4.5	3.8	3.2		3.3	2.2	2.3	2.2	2	130
135									4.4	3.9	3.2	2.6		2.7					135
140									3.9	3.4	2.7	2.1		2.2					140
145										2.9	2.2								145
150										2.5									150

t\_284\_001\_15305\_00\_000 · t\_284\_001\_10305\_00\_000



# Lifting capacities

## Forces de levage

T

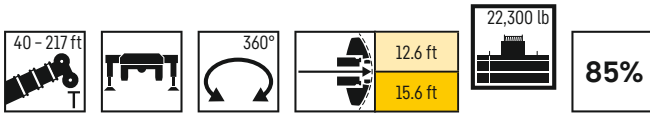

	40 ft	54 ft	68 ft	81 ft	95 ft	108 ft	121 ft	135 ft	148 ft	162 ft	176 ft	189 ft	196 ft	201 ft	202 ft	207 ft	214 ft	217 ft	
10	153.2	143.7	142.6	142.7	127.6														10
11	153.2	143.7	142.6	142.7	138.5														11
12	149.6	143.7	142.6	142.5	137.2														12
13	142.8	142.3	141.1	135.7	129.7	114.9													13
14	136	136	133.7	128.7	123.2	113.1													14
15	129.8	129.7	127.5	123.4	116.8	106.2	89.8												15
16	124	123.9	121.3	116.9	107.9	100	91.5												16
17	117.2	118.4	116.3	108.8	100.4	95.1	88.2												17
18	110.5	111.5	108.4	101	96.6	89.2	82.8												18
19	104.4	105.5	100.5	95	90.3	84	78.5	72.5											19
20	98.7	100.5	95.5	90.3	85.4	79.4	76	70.3											20
22	87.8	88.8	85.6	80.8	75.7	73.1	67.9	63.3	58.5										22
24	78.5	78.6	75.9	72	69.8	65.7	61.8	58.1	53.7	46.9									24
26	69.2	69.9	67.9	64.9	63.2	59.5	56.1	52.9	49.6	44.8									26
28	60.1	62.8	61.3	60.1	57.5	54.2	51.2	49.4	46	42.8	37.9								28
30	52.8	56.6	55.7	55.1	52.7	49.6	48.3	45.5	43	40	36.9	30.9							30
32	46.7	50.6	51	50.4	48.2	45.9	44.4	41.8	39.6	37	34.4	30.9	26.7	23.2					32
34		45.4	46.6	46.2	44.3	43.2	40.9	38.7	36.7	34.8	31.9	29.4	26.5	23.1	24.8	23			34
36		41	42.7	42.6	40.9	40	37.9	36.7	34.7	32.8	30.6	28.1	25.4	23	24.6	23	20.3	19.8	36
38		37	39.2	39.4	38.1	37.1	35.4	34.1	32.2	30.5	28.5	26.6	24	22.8	24.3	22.9	20.2	19.7	38
40		33.5	35.7	36.5	35.4	34.5	33.1	31.8	30	28.4	26.5	25	22.2	22.6	23	22.5	20.1	19.6	40
45		26.7	28.7	30.3	29.9	29.2	28	27.1	25.4	24.1	22.3	21	18.4	20.5	19.2	19.2	18.5	18.1	45
50			23.5	25.1	25.3	25	24	23.2	21.8	20.5	19	17.7	15.2	17.4	16.1	16.1	15.6	15.3	50
55			19.6	20.9	21.1	21.3	20.7	20	18.8	17.7	16.2	15.1	12.7	14.8	13.5	13.6	13.1	12.9	55
60			16.4	17.6	17.8	18	17.6	17.4	16.3	15.3	13.9	12.8	10.5	12.6	11.4	11.5	11.1	10.8	60
65				14.9	15.1	15.3	14.9	14.8	14	13.2	12	11	8.7	10.8	9.5	9.6	9.4	9.1	65
70				12.7	12.8	13	12.7	12.5	11.8	11.2	10.2	9.3	7.1	9.2	8	8.1	7.9	7.6	70
75					11	11.2	10.8	10.6	10	9.5	8.7	7.9	5.7	7.8	6.6	6.7	6.5	6.3	75
80					9.4	9.6	9.3	9.2	8.6	8.2	7.4	6.6	4.5	6.6	5.4	5.5	5.4	5.2	80
85					8.4	8.5	8.2	8.1	7.5	7.1	6.3	5.5	3.4	5.5	4.3	4.4	4.3	4.1	85
90						7.5	7.2	7.1	6.6	6.1	5.3	4.5	2.3	4.5	3.3	3.5	3.3	3.1	90
95						6.7	6.4	6.3	5.7	5.3	4.5	3.7		3.6	2.4	2.6	2.4	2.2	95
100						6.1	5.6	5.5	5	4.5	3.6	2.9		2.8					100
105							5	4.8	4.3	3.9	2.9	2.1		2					105
110							4.4	4.2	3.7	3.2	2.2								110
115								3.6	3.1	2.6									115
120								3.1	2.5	2									120
125								2.6	2										125

t\_284\_001\_15315\_00\_000 - t\_284\_001\_10315\_00\_000

# Lifting capacities

## Forces de levage

T



	40 ft	54 ft	68 ft	81 ft	95 ft	108 ft	121 ft	135 ft	148 ft	162 ft	176 ft	189 ft	196 ft	201 ft	202 ft	207 ft	214 ft	217 ft	
10	153.2	143.7	142.6	142.7	127.6														10
11	153.1	143.7	142.6	142.7	138.5														11
12	148.9	143.7	142.5	142.4	134.3														12
13	141.5	141.1	140.8	134	126	111.2													13
14	134.7	134.7	133.5	123.2	114.7	103.5													14
15	128.2	128.2	125.7	115.6	104.7	98.7	88.2												15
16	120.5	121	114.6	105.5	99.2	91.6	84.3												16
17	113.2	113.1	104.8	98.6	92.8	85.6	80.3												17
18	106.6	104	98.3	93.1	86.9	81.1	76.5												18
19	100.2	97.5	91.6	86.9	81.1	77.6	71.9	66.3											19
20	93.9	90.7	85.9	81.5	77.4	73.1	67.7	63.5											20
22	81.4	79.2	76.1	72.2	69.5	65	60.7	56.7	52.3										22
24	70.8	69.6	67.3	65.5	62.1	58.2	54.9	51.5	47.6	43.7									24
26	60.8	61.7	60.3	58.9	55.8	52.1	50.5	47.3	44.4	40.4									26
28	52.6	54.9	53.9	53	50.2	48.5	45.7	42.9	40.4	37.5	34.8								28
30	46	49	48.4	47.8	45.7	44.2	41.7	40.2	37.7	35.3	32.9	29.4							30
32	40	44	43.8	43.5	41.9	40.4	38.5	36.8	34.6	32.6	30.3	27.8	25.2	23.2					32
34		39.1	39.9	39.7	38.4	37.2	35.4	33.9	31.9	30.1	27.9	26.1	23.2	23.1	23.4	22.4			34
36		34.9	36.4	36.5	35.4	34.3	32.7	31.3	29.5	27.7	25.7	24.1	21.3	22.5	22	21.6	19.8	19.2	36
38		31.3	33.4	33.7	32.6	31.8	30.3	29.1	27.3	25.7	23.8	22.3	19.5	21.6	20.3	20.1	19.1	18.5	38
40		28.2	30.4	31.1	30.2	29.4	28.2	27	25.4	23.9	22.1	20.6	17.9	20.1	18.7	18.7	17.9	17.5	40
45		22.2	24.2	25.7	25.3	24.8	23.6	22.8	21.3	20	18.4	17.1	14.5	16.7	15.3	15.4	14.9	14.6	45
50			19.5	20.9	21.1	21	20.1	19.4	18.1	16.9	15.4	14.2	11.8	13.9	12.6	12.7	12.3	12	50
55			15.9	17.2	17.4	17.6	17.1	16.6	15.4	14.4	12.9	11.9	9.5	11.6	10.4	10.5	10.2	9.9	55
60			13.1	14.3	14.4	14.6	14.3	14.1	13.2	12.2	10.9	9.9	7.6	9.7	8.5	8.6	8.3	8.1	60
65				11.9	12	12.2	11.9	11.7	11	10.3	9.2	8.2	6	8	6.8	7	6.8	6.5	65
70				10	10.1	10.3	10	9.8	9.2	8.7	7.7	6.8	4.5	6.7	5.5	5.6	5.4	5.2	70
75					8.6	8.8	8.5	8.4	7.8	7.4	6.3	5.5	3.3	5.4	4.2	4.4	4.2	4	75
80					7.5	7.6	7.4	7.3	6.7	6.3	5.2	4.4	2	4.3	3.1	3.3	3.1	2.9	80
85					6.6	6.7	6.4	6.3	5.7	5.3	4.2	3.4		3.4		2.1			85
90						5.8	5.6	5.4	4.9	4.4	3.3	2.5		2.5					90
95						5.1	4.8	4.7	4.1	3.5	2.5								95
100						4.6	4.2	4	3.5	2.8									100
105							3.5	3.4	2.8	2.1									105
110							2.9	2.8	2.2										110
115								2.2											115

t\_284\_001\_15317\_00\_000 · t\_284\_001\_10317\_00\_000

# Lifting capacities

## Forces de levage

T

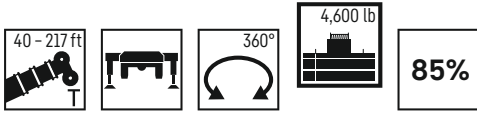

	40 ft	54 ft	68 ft	81 ft	95 ft	108 ft	121 ft	135 ft	148 ft	162 ft	176 ft	189 ft	196 ft	201 ft	202 ft	207 ft	214 ft	217 ft		
10	153.2	143.7	142.6	142.7	127.6															10
11	152.1	143.7	142.6	137.9	128.2															11
12	147.4	143.7	139.2	128.9	118															12
13	139.7	139.8	129.1	117.7	106	99.1														13
14	131.6	129.1	118	107.4	97.9	90.5														14
15	122.8	117.2	106.1	99.7	92	86.1	75.5													15
16	114.4	105.7	98.3	92	86.4	80.9	73.6													16
17	104.3	97.4	90.5	84.8	81.2	74.9	69													17
18	94.4	88.8	84.6	79.7	75.6	69.8	64.2													18
19	86	83	78.7	75.4	70.5	64.8	59.8	56.2												19
20	78.8	76.4	73.1	70.3	65.7	60.5	57.1	52.8												20
22	66.9	65.6	63.3	61	57.1	54.1	50.7	46.9	43.6											22
24	56.6	56.3	54.9	53.3	50.6	48.3	45.3	42.6	39.1	34.8										24
26	48.7	48.9	48.2	47.4	45.1	43.1	40.6	38.6	36	33.5										26
28	41.5	43.1	42.7	42.3	40.4	38.8	36.7	34.9	32.5	30.3	28									28
30	35.3	38.2	38.1	38	36.6	35.1	33.3	31.7	29.5	27.6	25.3	23.5								30
32	30.4	34.1	34.3	34.4	33.1	32	30.3	29	27	25.2	23.1	21.4	18.5	20.7						32
34		30.4	31	31.2	30.2	29.3	27.7	26.5	24.7	23.1	21.1	19.5	16.7	18.9	17.5	17.5				34
36		26.9	28.2	28.5	27.7	26.9	25.5	24.4	22.7	21.1	19.3	17.8	15.1	17.3	15.9	15.9	15.3	14.9		36
38		23.9	25.7	26.2	25.4	24.8	23.5	22.5	20.9	19.4	17.7	16.3	13.6	15.8	14.5	14.5	14.1	13.7		38
40		21.3	23.3	24.1	23.4	22.8	21.8	20.8	19.3	17.9	16.3	14.9	12.3	14.5	13.2	13.2	12.9	12.6		40
45		16.2	18	19.4	19.3	18.9	17.9	17.2	15.9	14.7	13.2	12	9.5	11.7	10.4	10.4	10.1	9.9		45
50			14	15.4	15.7	15.8	15	14.4	13.2	12.1	10.7	9.6	7.2	9.4	8.1	8.2	8	7.7		50
55			11	12.3	12.5	12.8	12.4	12	11	10	8.6	7.6	5.3	7.5	6.2	6.3	6.1	5.9		55
60			8.9	9.9	10.1	10.3	10	9.8	9.1	8.2	7	6	3.7	5.9	4.6	4.8	4.6	4.4		60
65				8.3	8.4	8.6	8.3	8.2	7.5	6.7	5.5	4.6		4.5	3.3	3.4	3.2	2.9		65
70				7	7.1	7.2	7	6.8	6.2	5.4	4.2	3.3		3.3	1.8					70
75					6	6.1	5.9	5.7	5	4.3	3.1	2.1		2.1						75
80					5	5.2	4.9	4.8	4	3.3	2									80
85					4.2	4.4	4.1	4	3.2	2.2										85
90						3.6	3.3	3.2	2.2											90
95						2.9	2.6	2.5												95
100						2.3	1.8													100

t\_284\_001\_15321\_00\_000



# Lifting heights

## Hauteurs de levage

TK/TNZK

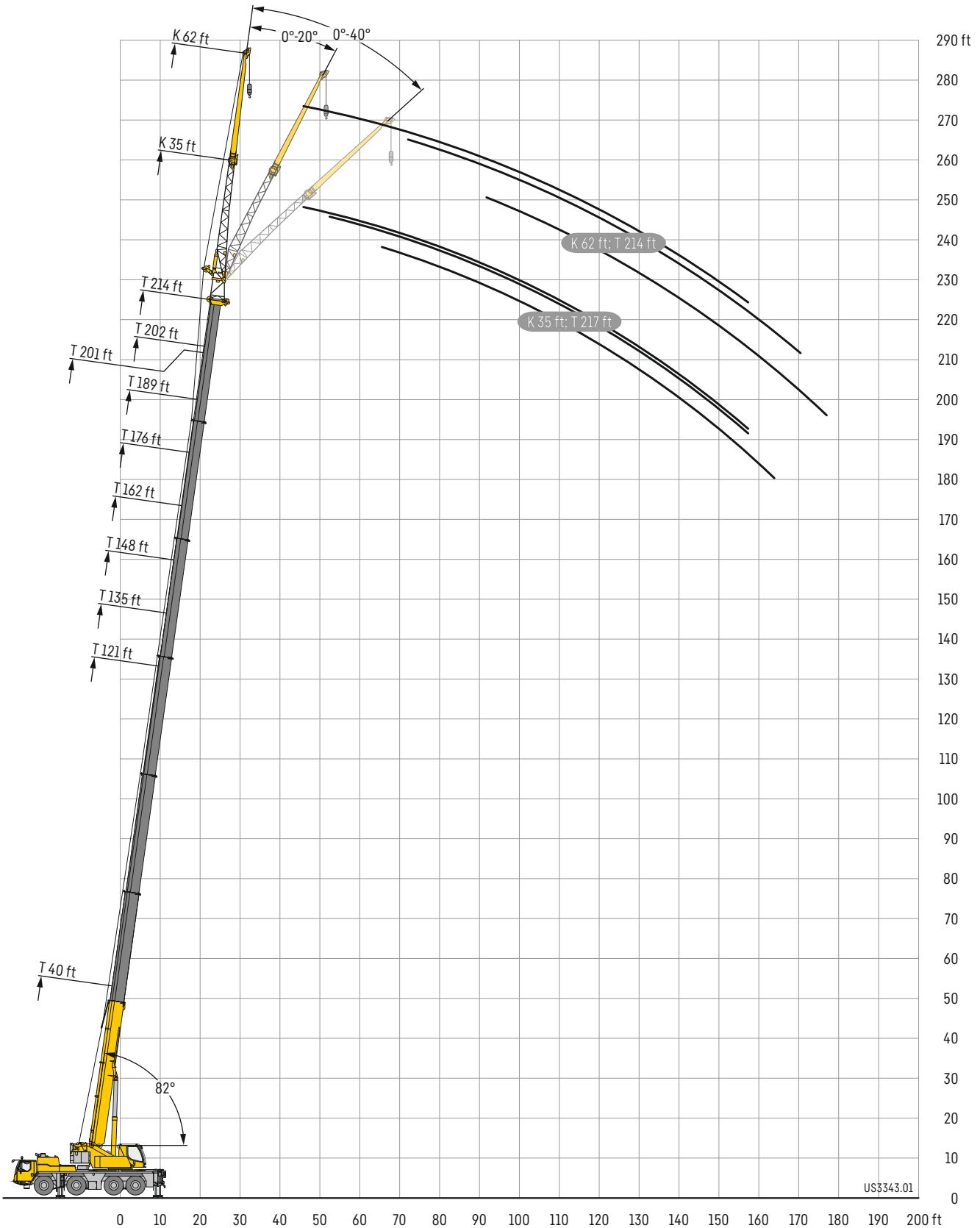

US3343.01

# Lifting capacities

## Forces de levage

# TK/TNZK

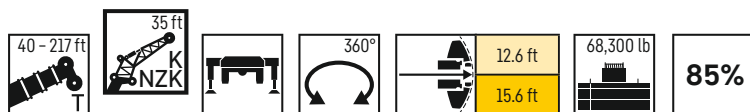

	40 ft		121 ft			135 ft			148 ft			162 ft			176 ft			189 ft			201 ft			202 ft			214 ft			217 ft								
	35 ft																																					
	0°	20°	40°	0°	20°	40°	0°	20°	40°	0°	20°	40°	0°	20°	40°	0°	20°	40°	0°	20°	40°	0°	20°	40°	0°	20°	40°	0°	20°	40°	0°	20°		40°				
10	32.5																																10					
11	32.5																																	11				
12	32.5																																		12			
13	32.5																																		13			
14	32.5	32.5																																	14			
15	32.5	32.5																																		15		
16	32.5	32.5																																		16		
17	32.5	32.4																																		17		
18	32.5	32.1																																		18		
19	32.5	31.5																																		19		
20	32.5	30.7																																		20		
22	32.3	29.2		32.5																																22		
24	31.3	27.8	21.6	32.5																																24		
26	29.6	26.6	20.9	32.5			32.5																													26		
28	28	25.4	20.2	32.5			32.5																														28	
30	26.4	24.4	19.6	32.5	32.5		32.5				32.4																										30	
32	24.8	23.4	19	32.5	32.3		32.5				32.3																										32	
34	23.4	22.5	18.6	32.5	32		32.5	30.7		32.1					27.3																						34	
36	22.2	21.7	18.1	32.5	31.4		32.5	30.3		32	28.4				27.2																						36	
38	21	20.9	17.7	32.5	30.7	21.3	32.5	29.9		31.8	28.1				27.1									22.1													38	
40	20	20.2	17.3	32.5	30	21	32.5	29.5	21.1	31.5	27.8				26.9	24.9							22													40		
45	17.7	18.7	16.5	32.5	28.3	20.3	32.5	28.4	20.4	30.9	26.9	20.3			26.6	24.4							21.9	20.3												45		
50	15.9	17.5	16	32.5	26.7	19.6	32.4	27.1	19.8	30.2	26.2	19.7	26.2	23.9	19.5	21.5	20.1					17.3	16.1													50		
55	14.3	16.5	15.7	31.8	25.4	19	31.1	25.8	19.2	29.3	25.4	19.2	25.9	23.4	19	21	20	18.5				16.8	16													55		
60	13.1	14.8	15.3	29.9	24.2	18.5	28.5	24.6	18.6	27	24.6	18.7	25.2	22.9	18.5	20.5	19.8	18.1				16.5	15.8	15.3												60		
65	12.1	13	8.8	27.1	23.1	18	25.4	23.5	18.2	24.5	23.6	18.2	22.7	22.5	18.1	20.1	19.6	17.8				16.1	15.7	15.3												65		
70				24.3	22.1	17.6	22.7	22.6	17.7	21.9	22.4	17.8	20.9	21.8	17.7	19	19.3	17.4				15.8	15.6	15.3												70		
75				21.7	21.2	17.2	20.4	21.5	17.4	19.6	20.9	17.5	19.1	19.9	17.3	17.5	18.9	17.1				15.6	15.4	15.3												75		
80				19.2	20.4	16.8	18.2	19.5	17	17.6	19	17.1	17.1	18.4	17.1	16.4	17	16.8				14.8	15.2	15												80		
85				17	18.2	16.5	16	17.3	16.7	15.6	17	16.7	15.4	16.7	16.5	15.1	15.3	16				13.7	14.6	14.5												85		
90				15.2	16.2	16.3	14.2	15.3	16	13.8	15	15.9	13.7	14.9	15.9	13.7	14.5	14.8				12.3	13.5	13.9													90	
95				13.5	14.4	15.1	12.5	13.5	14.4	12.3	13.2	14.1	12.5	13.2	14.1	12.4	13.3	14				11.6	12.1	13.1													95	
100				12	12.9	13.5	11.4	12	12.7	11.7	11.7	12.5	12	11.7	12.5	11.7	11.8	12.6				11	10.9	11.8													100	
105				10.7	11.5	12	10.8	10.6	11.2	11.1	10.8	11	11.3	11.1	11	10.6	11.1	11.2				9.9	10.5	10.5													105	
110				9.5	10.2	10.6	10.2	10.1	10.1	10.5	10.4	10.4	10.3	10.6	10.6	9.5	10.2	10.5				9	9.8	10													110	
115				8.9	9.1	9.5	9.7	9.6	9.7	9.8	9.9	9.9	9.2	9.8	10.1	8.6	9.2	9.7				8.1	8.8	9.3													115	
120				8.5	8.6	8.7	9.2	9.2	9.3	9	9.4	9.5	8.5	9	9.4	7.8	8.4	8.8				7.3	7.9	8.4													120	
125				8.1	8.2	8.3	8.8	8.8	8.9	8.2	8.7	9	7.7	8.2	8.6	7.1	7.6	8				6.6	7.2	7.6													125	
130				7.7	7.8	7.9	8.2	8.4	8.5	7.6	8	8.2	7.1	7.5	7.8	6.4	6.9	7.3				5.9	6.5	6.9													130	
135				7.4	7.5	7.6	7.6	7.9	8	7	7.3	7.5	6.5	6.9	7.2	5.8	6.3	6.6				5.3	5.9	6.2													135	
140				7.1	7.1	7.2	7	7.3	7.4	6.4	6.7	6.9	5.9	6.3	6.5	5.2	5.7	6				4.8	5.3	5.6													140	
145				6.8			6.5	6.7	6.8	5.9	6.2	6.3	5.4	5.8	6	4.7	5.2	5.4				4.3	4.7	5													145	
150							6	6.2	6.2	5.5	5.7	5.8	4.9	5.3	5.4	4.3	4.6	4.9				3.7	4.2	4.5													150	
155							5.6	5.7	5.7	5	5.2	5.3	4.5	4.8	4.9	3.7	4.2	4.4				3.2	3.7	4													155	
160							5.3			4.6	4.8	4.8	4	4.3	4.5	3.2	3.6	3.9				2.7	3.2	3.4													160	
165							4.1	4.3	4.3	3.6	3.8	3.9	2.8	3.2	3.3	2.2	2.7	2.9				2.2	2.7	2.9													165	
170							3.7	3.8	3.7	3.1	3.4	3.4	2.4	2.7	2.8	1.8	2.2	2.4																				170
175							3			2.7			1.9																									175
180													2.4																									180
185													2																									185

t\_284\_003\_00501\_00\_000 · t\_284\_003\_00001\_00\_000

# Lifting capacities

## Forces de levage

# TK/TNZK

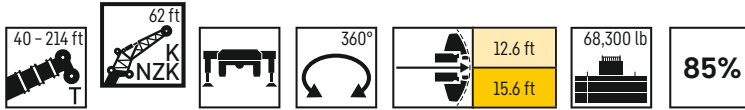

	40 ft			121 ft			135 ft			148 ft			162 ft			176 ft			189 ft			201 ft			202 ft			214 ft			
	62 ft																														
	0°	20°	40°	0°	20°	40°	0°	20°	40°	0°	20°	40°	0°	20°	40°	0°	20°	40°	0°	20°	40°	0°	20°	40°	0°	20°	40°	0°	20°	40°	
11	15.6																														11
12	15.5																														12
13	15.4																														13
14	15.3																														14
15	15.1																														15
16	15																														16
17	14.8																														17
18	14.6																														18
19	14.4																														19
20	14.2																														20
22	13.8																														22
24	13.4																														24
26	13																														26
28	12.6	10.6																													28
30	12.2	10.2																													30
32	11.8	9.9																													32
34	11.4	9.7																													34
36	11.1	9.4																													36
38	10.7	9.2																													38
40	10.4	9																													40
45	9.7	8.6	7.7																												45
50	9.2	8.2	7.4																												50
55	8.7	7.9	7.2																												55
60	8.1	7.6	7																												60
65	7.6	7.4	6.9																												65
70	7.1	7.2	6.8																												70
75	6.6	7	6.8																												75
80	6.2	6.9	6.8																												80
85	5.8	6.9	6.8																												85
90	5.5	6.8	6.8																												90
95	5.2																														95
100																															100
105																															105
110																															110
115																															115
120																															120
125																															125
130																															130
135																															135
140																															140
145																															145
150																															150
155																															155
160																															160
165																															165
170																															170
175																															175
180																															180
185																															185
190																															190
195																															195
200																															200

t\_284\_003\_03501\_00\_000 · t\_284\_003\_03001\_00\_000

# Lifting heights

## Hauteurs de levage

TVK/TVNZK

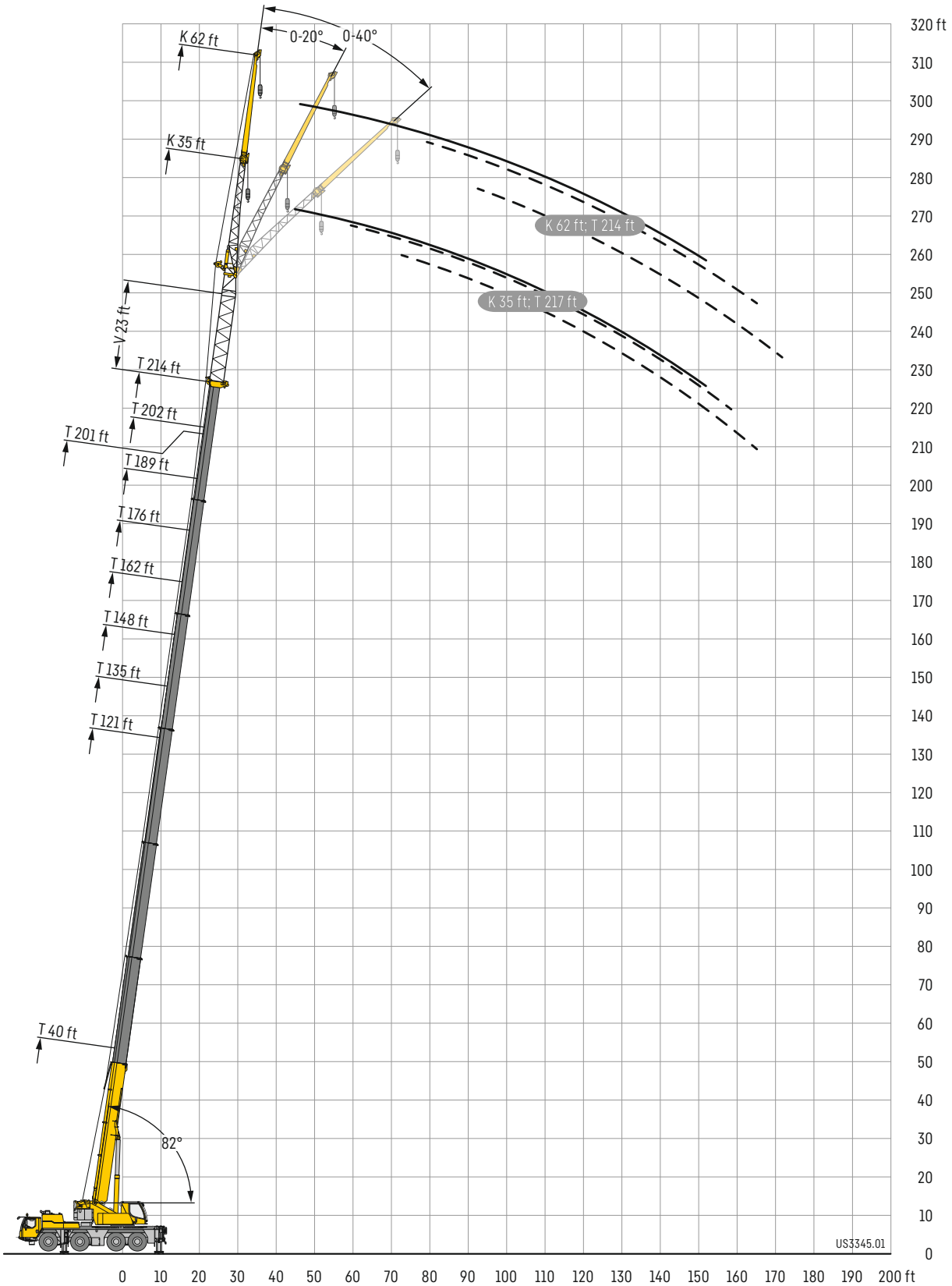

# Lifting capacities

## Forces de levage

# TVK/TVNZK

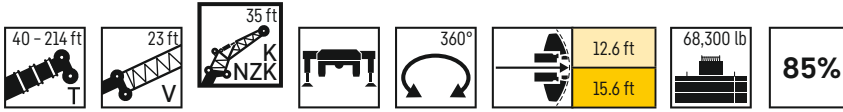

	40 ft + 23 ft		121 ft + 23 ft		135 ft + 23 ft		148 ft + 23 ft		162 ft + 23 ft		176 ft + 23 ft		189 ft + 23 ft		201 ft + 23 ft		202 ft + 23 ft		214 ft + 23 ft							
	35 ft																									
	0°	20°	40°	0°	20°	40°	0°	20°	40°	0°	20°	40°	0°	20°	40°	0°	20°	40°	0°	20°		40°	0°	20°	40°	
10	28.9																								10	
11	28.6																									11
12	28.2																									12
13	27.9																									13
14	27.5																									14
15	27.1																									15
16	26.6																									16
17	26.2																									17
18	25.7	24																								18
19	25.2	23.6																								19
20	24.8	23.2																								20
22	23.8	22.3																								22
24	22.9	21.5																								24
26	22.1	20.7																								26
28	21.3	19.9	18.9																							28
30	20.5	19.2	18.3																							30
32	19.8	18.5	17.6																							32
34	19.1	17.9	17.1																							34
36	18.4	17.3	16.5																							36
38	17.8	16.7	16																							38
40	17.2	16.2	15.5																							40
45	15.8	15	14.5																							45
50	14.6	13.9	13.5																							50
55	13.4	12.9	12.7																							55
60	12.4	12	11.8																							60
65	11.5	11.2	11.1																							65
70	10.7	10.5	10.5																							70
75	10.1	9.9	10																							75
80	9.5	9.4	9.7																							80
85	9	9.1	9.3																							85
90	8.5	8.6																								90
95																										95
100																										100
105																										105
110																										110
115																										115
120																										120
125																										125
130																										130
135																										135
140																										140
145																										145
150																										150
155																										155
160																										160
165																										165
170																										170
175																										175
180																										180
185																										185
190																										190
195																										195

t\_284\_005\_00501\_00\_000 - t\_284\_005\_00001\_00\_000



# Lifting capacities

## Forces de levage

# TVK/TVNZK

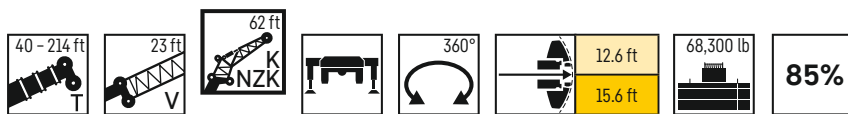

	40 ft + 23 ft			121 ft + 23 ft			135 ft + 23 ft			148 ft + 23 ft			162 ft + 23 ft			176 ft + 23 ft			189 ft + 23 ft			201 ft + 23 ft			202 ft + 23 ft			214 ft + 23 ft			
	62 ft																														
	0°	20°	40°	0°	20°	40°	0°	20°	40°	0°	20°	40°	0°	20°	40°	0°	20°	40°	0°	20°	40°	0°	20°	40°*	0°	20°	40°	0°	20°	40°*	
15	13.5																													15	
16	13.4																													16	
17	13.4																													17	
18	13.3																													18	
19	13.2																													19	
20	13.1																													20	
22	13																													22	
24	12.8																													24	
26	12.6																													26	
28	12.3																													28	
30	12.1																													30	
32	11.9	10				13.4																								32	
34	11.6	9.8				13.3																								34	
36	11.4	9.6				13.2				12.5												9.1								36	
38	11.1	9.4				13.1				12.4												9.1								38	
40	10.9	9.2				13				12.3												9								40	
45	10.3	8.8				12.7				12.1												11.4								45	
50	9.8	8.5	7.5			12.4	9.7			11.9	9.6											10.2								50	
55	9.3	8.2	7.3			12	9.4			11.7	9.3											10	9.2							55	
60	8.9	7.9	7.2			11.7	9.1			11.4	9.1											9.9	8.8							60	
65	8.5	7.7	7			11.3	8.9	7.5		11.1	8.9	7.5										9.8	8.6							65	
70	8.1	7.5	6.9			10.9	8.7	7.4		10.8	8.7	7.4										9.6	8.4							70	
75	7.6	7.3	6.8			10.5	8.5	7.3		10.5	8.5	7.3										9.4	8.3	7.2						75	
80	7.3	7.1	6.8			10.2	8.3	7.2		10.1	8.3	7.2										9.2	8.1	7.1						80	
85	6.9	6.8	6.7			9.8	8.2	7.1		9.8	8.2	7.1										9	8	7						85	
90	6.6	6.5	6.6			9.6	8	7		9.6	8	7										8.8	7.9	7						90	
95	6.3	6.3	6.4			9.3	7.9	7		9.3	7.9	7										8.6	7.8	6.9						95	
100	6.1	6	6.2			9.1	7.7	6.9		9.1	7.8	6.9										8.4	7.7	6.9						100	
105	5.8	5.8	6.1			8.8	7.6	6.9		8.8	7.7	6.9										8.2	7.5	6.8						105	
110	5.5	5.7	6			8.5	7.5	6.8		8.6	7.5	6.8										7.9	7.4	6.8						110	
115	5.2	5.6				8.3	7.4	6.8		8.3	7.4	6.8										7.6	7.3	6.8						115	
120						8	7.3	6.8		7.8	7.3	6.8										7.2	7.1	6.7						120	
125						7.8	7.1	6.8		7.2	7.2	6.7										6.6	7	6.7						125	
130						7.3	7	6.7		6.5	7.1	6.7										6	6.7	6.6						130	
135						6.7	6.9	6.7		5.9	6.7	6.7										5.7	6.5	6.6						135	
140						6.1	6.7	6.6		5.4	6.2	6.6										5.5	5.9	6.4						140	
145						5.6	6.3	6.5		5.2	5.6	6.2										5.4	5.3	6						145	
150						5.1	5.7	6.1		5	5.1	5.6										5.1	5.2	5.3						150	
155						4.6	5.2	5.6		4.8	4.9	5.1										4.9	5	5						155	
160						4.4	4.7	5.1		4.7	4.7	4.8										4.7	4.8	4.9						160	
165						4.2	4.3	4.6		4.5	4.6	4.7										4.4	4.6	4.8						165	
170						4	4.1	4.2		4.3	4.4	4.5										4	4.4	4.6						170	
175						3.9	4	4.1		4.2	4.2	4.3										3	3.7	4						175	
180						3.7	3.8			3.8	4.1	4.2										3	3.3	3.6						180	
185						3.5	3.6			3.5	3.9	4										2.3	3.3	3.6						185	
190						3.4	3.4			3.1	3.5											2.5	2.9	3.2						190	
195						3.2				2.8	3.1											2.1	2.6	2.7						195	
200										2.5	2.7											1.8	2.2	2.3						200	
205										2.2	2.4																			205	
210										2																				210	

\* only possible in TVNZK mode - uniquement possible en cas de fonctionnement de la pointe pliante hydraulique de la fleche telescopique (TVNZK)

t\_284\_005\_03501\_00\_000 - t\_284\_005\_03001\_00\_000

# Lifting heights

## Hauteurs de levage

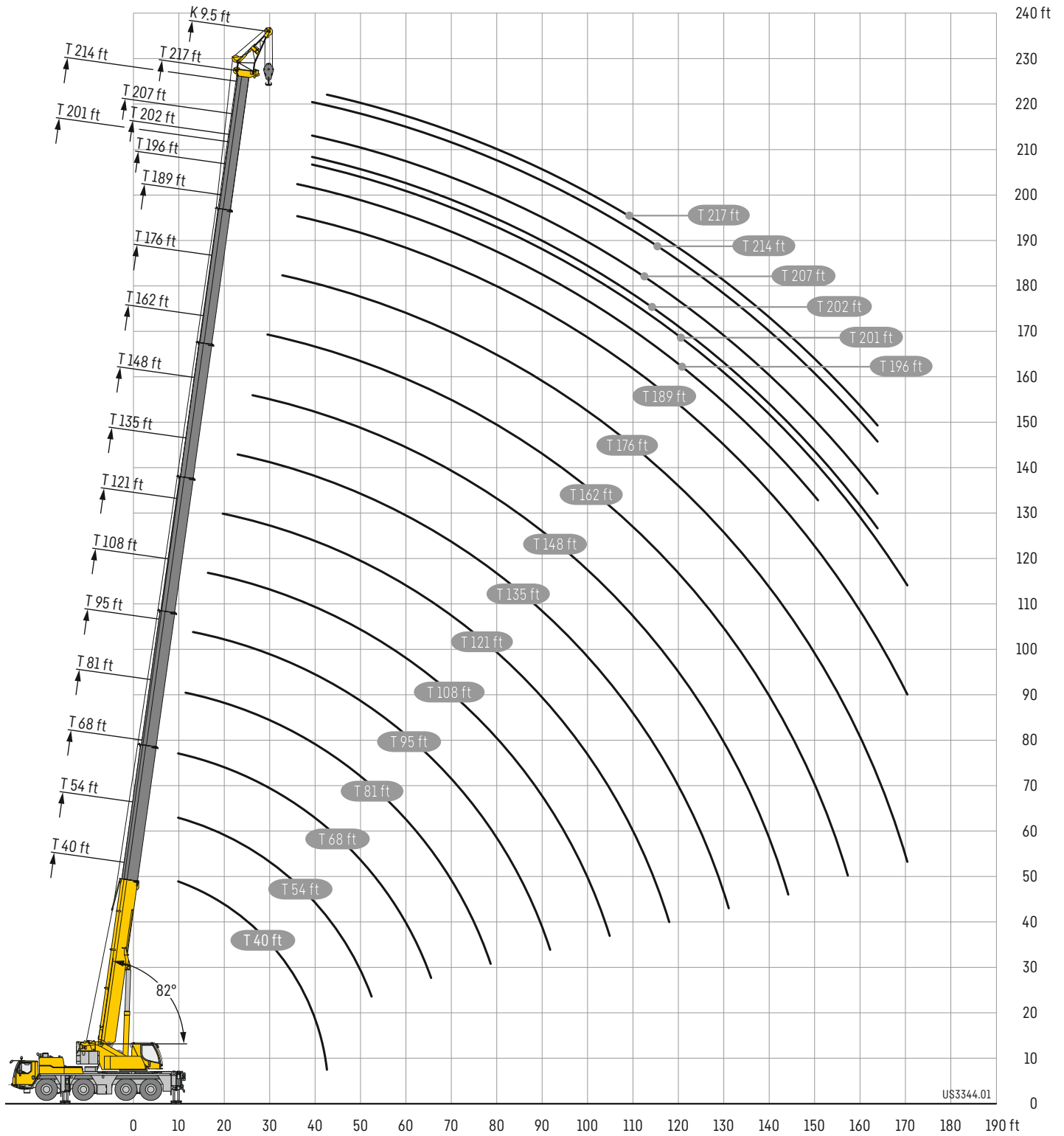

# Lifting capacities

## Forces de levage

TK

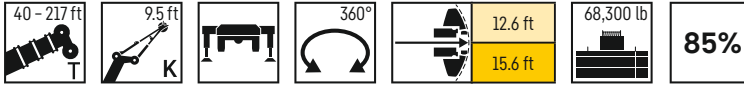

	40 ft	54 ft	68 ft	81 ft	95 ft	108 ft	121 ft	135 ft	148 ft	162 ft	176 ft	189 ft	196 ft	201 ft	202 ft	207 ft	214 ft	217 ft	
	9.5 ft																		
10	64.1	64.1	64.1																10
11	64.1	64.1	64.1	64.1															11
12	64.1	64.1	64.1	64.1															12
13	64.1	64.1	64.1	64.1	64.1														13
14	64.1	64.1	64.1	64.1	64.1														14
15	64.1	64.1	64.1	64.1	64.1														15
16	64.1	64.1	64.1	64.1	64.1	64.1													16
17	64.1	64.1	64.1	64.1	64.1	64.1													17
18	64.1	64.1	64.1	64.1	64.1	64.1													18
19	64.1	64.1	64.1	64.1	64.1	64.1	64.1												19
20	64.1	64.1	64.1	64.1	64.1	64.1	64.1												20
22	64.1	64.1	64.1	64.1	64.1	64.1	64.1												22
24	64.1	64.1	64.1	64.1	64.1	64.1	64.1	64.1											24
26	64.1	64.1	64.1	64.1	64.1	64.1	64.1	64	51.7										26
28	64.1	64.1	64.1	64.1	64.1	64.1	64.1	63.7	51.6	36.3									28
30	64.1	64.1	64.1	64.1	64.1	64.1	64.1	63.9	61.1	41.9									30
32	64.1	64.1	64.1	64.1	64.1	64.1	62	58.5	51.1	41.8	33.8								32
34	64.1	64.1	64.1	64.1	63.7	62.8	59.3	56.3	50.7	41.6	33.8	24.3							34
36	63.3	63.8	64.1	63.4	62.3	60.3	56.7	53.8	50.1	41.4	33.7	26.4	22.9						36
38	59.4	60.3	60.6	61.7	60.2	57.8	54.3	51.5	48.3	41.1	33.5	26.3	22.8	19.6	21.2	19.4			38
40	55.6	56.6	57	58.1	57.6	55.2	52.2	49.4	46.4	40.8	33.3	26.1	22.7	19.5	21.2	19.4	17.2	16.8	40
45		48.4	49.9	50	49.7	48.6	46.3	43.8	42.2	39.7	32.6	25.8	22.2	19.1	21	19.2	17	16.6	45
50		42	43.4	43.6	43.2	42.4	40.4	39.8	38.1	35.8	31.8	25.4	21.4	18.6	20.6	18.9	16.8	16.4	50
55		36.7	38.2	38.3	37.9	37.1	37.2	35.5	33.7	32.4	30.6	24.9	20.6	18.1	20.3	18.6	16.5	16.1	55
60			33.8	33.9	33.5	33.4	33.4	31.6	30.5	29.2	27.3	24.2	19.7	17.6	19.9	18.3	16.1	15.8	60
65			30	30.1	29.7	30.5	29.7	28.9	27.3	26.2	25.1	23.5	18.9	17.1	19.4	17.9	15.8	15.4	65
70				26.7	27.3	27.2	26.3	25.8	25	24.1	23.1	21.5	18	16.5	18.9	17.5	15.4	14.8	70
75				23.9	24.8	24.3	23.4	23.5	22.9	22.1	20.8	19.4	17.1	15.9	18.2	17	14.9	14.3	75
80				21.7	22.3	21.8	21	21	20.7	19.8	18.8	18.2	16.1	15.3	16.9	16.3	14.4	13.7	80
85					20.2	19.6	19.4	18.9	18.5	17.9	17.5	16.6	14.7	14.6	15.3	15.1	13.9	13.2	85
90					18.3	17.6	17.8	17.1	16.5	16.5	15.6	15	13.1	14	13.8	13.8	13.3	12.5	90
95					16.6	15.9	16.1	15.4	15.1	14.8	13.9	13.3	11.6	13.1	12.3	12.4	12.1	11.7	95
100						14.9	14.6	14.4	13.9	13.3	12.4	11.9	10.1	11.8	10.9	11	10.8	10.6	100
105						13.9	13.2	13.2	12.5	11.9	11.1	10.5	9	10.5	9.6	9.7	9.6	9.5	105
110						10.7	12	12	11.3	10.7	9.9	9.4	8	9.3	8.6	8.7	8.6	8.5	110
115							11	10.8	10.2	9.7	9	8.5	7.1	8.5	7.7	7.8	7.7	7.6	115
120							10	9.9	9.3	8.8	8.2	7.7	6.3	7.7	6.9	7	7	6.8	120
125								9.1	8.5	8.1	7.4	7	5.6	6.9	6.2	6.3	6.2	6.1	125
130								8.4	7.9	7.4	6.8	6.3	5	6.3	5.6	5.6	5.6	5.4	130
135								7.8	7.3	6.8	6.2	5.7	4.3	5.7	4.9	5	5	4.8	135
140									6.7	6.2	5.6	5.1	3.6	5.1	4.4	4.5	4.4	4.3	140
145									6.2	5.7	5.1	4.6	3	4.6	3.8	3.9	3.9	3.7	145
150									5.2	5.3	4.6	4.1	2.4	4.1	3.2	3.4	3.3	3.1	150
155										4.8	4	3.5	1.9	3.6	2.7	2.8	2.8	2.6	155
160										4.3	3.6	3		3	2.1	2.3	2.3	2.1	160
165											3.1	2.5		2.6		1.8	1.8		165
170											2.7	2.1		2.1					170
175											2.3								175

t\_284\_006.00501\_00\_000 · t\_284\_006.00001\_00\_000

# Equipment

## Crane carrier

<b>Frame</b>	Liebherr designed and manufactured, box-type, torsion resistant design of hightensile fine grained structural steel.
<b>Outriggers</b>	4-point supporting system, hydraulically telescopable into horizontal and vertical direction. Operation with remote control, automatic support leveling, electronic inclination display.
<b>Engine</b>	6-cylinder Diesel, make Liebherr, watercooled, output 330 kW (449 h.p.), max. torque 1722 lb-ft. Exhaust emissions acc. to (EU) 2016/1628, EPA/CARB or ECE-R.96. Fuel reservoir: 145 gallons.
<b>Transmission</b>	ZF 12-speed gear box with automatic control system. ZF-intarder fitted directly to the gear. Two-stage transfer case with lockable transfer differential.
<b>Axles</b>	Low maintenance carrier axles, all 4 axles steered. Axle 2, 3 and 4 are equipped with planetary gears, all driven axles with transverse differential locks.
<b>Cardan shaft</b>	All cardan shafts with 70° diagonal toothing and maintenance free.
<b>Suspension</b>	All axles are mounted on hydropneumatic suspension – “Niveumatik suspension” and are lockable hydraulically.
<b>Tyres</b>	8 tyres, size: 445/95 R 25 (16.00 R 25).
<b>Steering</b>	2-circuit system with hydraulic servo steering. Active speed depending rear axle steering, special steering programs for various driving situations.
<b>Brakes</b>	Service brake: all-wheel servo-air brake, all axles are equipped with disc brakes, dual circuit. Parking brake: Spring brake actuator, acting on the wheels of the 2nd to 4th axle. Sustained-action brakes: Engine brake as exhaust retarder with Liebherr additional brake system ZBS. Intarder 3 in gearbox.
<b>Driver's cab</b>	Spacious corrosion resistant with comfort furnishings, mounted on rubber shock absorbers, safety glazing.
<b>Electrical system</b>	Modern data bus technique, 24 Volt DC.

## Crane superstructure

<b>Frame</b>	Liebherr-manufactured, torsionally rigid steel construction made from high-tensile fine-grain steel. Triple-roller slewing rim.
<b>Crane drive</b>	Diesel-hydraulic with axial variable displacement pumps with automatic capacity control, 1 double gear pump, driven by the carrier Diesel engine, open regulated oil circuits with electrically controlled “load sensing”, operation of 4 movements simultaneously.
<b>Control</b>	Electric “Load Sensing” control, simultaneous operation of 4 working motions, 2 self-centering hand control levers (joy-stick type).
<b>Hoist gear</b>	Axial piston fixed displacement motor, Liebherr hoist drum with integrated planetary gear and spring-loaded static brake.
<b>Luffing gear</b>	1 differential ram with pilot-controlled brake valve.
<b>Slewing gear</b>	Axial piston fixed displacement motor, planetary gear, spring-loaded static brake. Slewing gear invertible from released to locked as a standard feature.
<b>Crane cab</b>	Large screen area, compound glass, comfort furnishing, cabin tilttable 20° to rear.
<b>Safety devices</b>	LICCON2 safe load indicator, test system hoist limit switch, safety valves to prevent pipe and hose ruptures.
<b>Telescopic boom</b>	1 base section and 6 telescopic sections. All telescopic sections hydraulically extendable independent of one another. Rapid-cycle telescoping system TELEMATIK. Boom length: 40 ft – 217 ft.
<b>Counterweight</b>	44,100 lb
<b>Electrical system</b>	Modern data bus technique, 24 Volt DC.

## Additional equipment

<b>K</b>	Assembly jib 9.5 ft.
<b>K</b>	Single folding jib, 35 ft. Double swing-away jib 35 ft – 62 ft. Mechanical adjustment 0°; 20°; 40°.
<b>NZK</b>	Single folding jib, 35 ft. Double swing-away jib 35 ft – 62 ft. Hydraulic adjustment 0° – 40°.
<b>V</b>	Telescopic boom extension 23 ft.
<b>2nd hoist gear</b>	For two-hook operation or for operation with swing-away jib if the hoist rope shall remain reeved.
<b>Additional counterweight</b>	24,200 lb for a total counterweight of 68,300 lb.
<b>Tyres</b>	8 tyres, size 525/80 R 25 (20.5 R 25).
<b>Other items of equipment available on request.</b>	

# Équipement

## Châssis porteur

<b>Cadre</b>	Fabrication Liebherr, construction en caisson indéformable, en acier à haute résistance à grains fins.
<b>Calage</b>	Dispositif de calage horizontal et vertical en 4 points, entièrement déployable hydrauliquement. Utilisation avec commande à distance, mise à niveau automatique du calage, inclinomètre électronique.
<b>Moteur</b>	Moteur diesel, 6 cylindres, fabriqué par Liebherr, à refroidissement par eau, de 330 kW (449 ch), couple max. 1722 lb-ft. Emissions des gaz d'échappement conformes au directive (EU) 2016/1628, EPA/CARB ou ECE-R.96. Capacité du réservoir à carburant: 145 gallons.
<b>Boîte de vitesse</b>	Boîte de vitesses ZF à 12 rapports, mécanisme automatisé à commande. Ralentisseur hydrodynamique ZF directement accouplé à la boîte. Boîte de transfert à 2 étages avec blocage de différentiel.
<b>Essieux</b>	Essieux nécessitant peu d'entretien, les 4 essieux sont directeurs. Les essieux 2, 3 et 4 sont des essieux planétaires, tous les essieux moteurs avec différentiel transversal.
<b>Arbres articulés</b>	Tous les flasques de croisillons avec denture en croix 70° et sans entretien.
<b>Suspension</b>	Suspension hydropneumatique «Niveumatik» – sur tous les essieux. Chaque essieu peut être bloqué hydrauliquement.
<b>Pneumatiques</b>	8 pneus de taille: 445/95 R 25 (16.00 R 25).
<b>Direction</b>	2 circuits avec direction assistée hydraulique. Direction active des essieux arrière et dépendante de la vitesse, programmes de direction spéciaux pour les différents modes de déplacement.
<b>Freins</b>	Freins de service: servofrein à air comprimé, tous les essieux sont munis de freins à disque, à 2 circuits. Frein à main: ressort accumulé agissant sur les roues des essieux 2 à 4. Freins continus: frein moteur par clapet sur échappement avec système de ralentissement Liebherr ZBS. Ralentisseur 3 monté sur boîte de vitesse.
<b>Cabine</b>	Spacieuse cabine, traitement anticorrosion, équipement «grand confort», suspension par silentbloks, vitrage de sécurité.
<b>Installation électrique</b>	Technique moderne de transmission de données par BUS de données, courant continu 24 Volts.

## Partie tournante

<b>Cadre</b>	Fabrication Liebherr, construction soudée indéformable, en acier à grain fin haute résistance. Couronne d'orientation à triple rangée de rouleaux.
<b>Entraînement</b>	Diesel hydraulique avec pompes à débit variable et régulation de puissance automatique, 1 pompe à engrenages double, entraînés par le moteur Diesel du porteur, circuits hydrauliques ouverts avec «load sensing», régulé électriquement. 4 mouvements simultanés praticables.
<b>Commande</b>	Direction électrique «Load Sensing», 4 mouvements de travail dirigeable simultanément, deux leviers de commande à 4 positions et à auto-centrage.
<b>Mécanisme de levage</b>	Moteur à cylindrée constante et à pistons axiaux. Treuil de marque Liebherr équipé d'un engrenage planétaire et d'un frein d'arrêt commandé par ressort.
<b>Mécanisme de relevage</b>	1 vérin différentiel avec clapet de frein commandé.
<b>Dispositif de rotation</b>	Moteur à cylindrée constante à pistons axiaux, engrenage planétaire, frein d'arrêt commandé par ressort. Orientation de série commutable en circuit hydraulique ouvert ou fermé (freinage automatique ou au pied).
<b>Cabine de grue</b>	Large champ de vision, vitrage de sécurité, équipement pour un confort idéal, cabine inclinable de 20° vers l'arrière.
<b>Dispositif de sécurité</b>	Contrôleur de charge «LICCON2», système test limitation de la course pour le levage, soupape de sûreté contre la rupture de tubes et de tuyaux.
<b>Flèche télescopique</b>	1 élément de base et 6 éléments télescopiques. Tous les éléments télescopables indépendamment les uns des autres. Système de télescopage séquentiel rapide, TELEMATIK. Longueur de flèche: 40 ft – 217 ft.
<b>Contrepoids</b>	44,100 lb
<b>Installation électrique</b>	Technique moderne de transmission de données par BUS de données. Courant continu 24 Volts.

## Équipement supplémentaire

<b>K</b>	Flechette de montage 9.5 ft.
<b>K</b>	Flechette pliante simple, longueur 35 ft. Double flechette pliante 35 ft – 62 ft. Réglage mécanique 0° ; 20° ; 40°.
<b>NZK</b>	Flechette pliante simple, longueur 35 ft. Double flechette pliante 35 ft – 62 ft. Réglage hydraulique 0° – 40°.
<b>V</b>	Rallonge flèche télescopique 23 ft.
<b>2ème mécanisme de levage</b>	Pour l'utilisation du deuxième crochet, ou bien pour une utilisation avec fléchette pliante lorsque le câble de levage principal rest mouflé.
<b>Contrepoids additionnel</b>	24,200 lb pour un contrepoids total de 68,300 lb.
<b>Pneumatiques</b>	8 pneus. Taille: 525/80 R 25 (20.5 R 25).
<b>Autres équipements supplémentaires sur demande.</b>	



# Description of symbols

## Explication des symboles



**Max. capacity**  
Capacité max.



**Max. hoist height**  
Hauteur de levage max.



**Max. radius**  
Portée max.



**Tyres**  
Pneumatiques



**Hookblock/Capacity**  
Moufle à crochet/Capacité de charge



**No. of sheaves**  
Poulies



**No. of lines**  
Brins



**Weight**  
Poids



**Crane carrier**  
Châssis porteur



**Driving speed**  
Vitesse de translation



**Gradability**  
Aptitude à gravir les pentes



**Transmission**  
Boîte de vitesse



**Gear**  
Vitesse



**Driving speed - Onroad gear**  
Vitesse de translation - Vitesse de route



**Driving speed - Crawl speed**  
Vitesse de translation - Marche lente



**Crane superstructure**  
Partie tournante de la grue



**infinitely variable**  
en continu



**Rope diameter**  
Diamètre



**Rope length**  
Longueur du câble



**Max. single line pull**  
Effort au brin maxi.



**Hoist gear**  
Treuil de levage



**Slewing speeds**  
Vitesses d'orientation



**Boom length**  
Longueur de la flèche



**Boom position**  
Position de la flèche



**Counterweight**  
Contrepoids



**Counterweight radius**  
Rayon de contrepoids



**Outriggers**  
Calage



**Slewing gear / Working area**  
Mécanisme d'orientation / Plage de travail



**Standard**  
Norme



**Radius**  
Portée



**Telescopic boom**  
Flèche télescopique



**Mechanically/hydraulically adjustable folding jib**  
Pointe pliante réglable mécaniquement/hydrauliquement



**Telescopic boom extension**  
Rallonge flèche télescopique



**Assembly jib**  
Flechette de montage

## Remarks

1. The lifting capacities do not exceed 85 % of the tipping load according to ASME B 30.5. The crane's structural steelwork is in accordance with EN 13000 and ASME B 30.5.
2. For the calculation of the load charts at least a wind speed of 30 ft/s (9 m/s, 20 mph) and regarding the load a sail area of 1 m<sup>2</sup> per ton load and a wind resistance coefficient of 1.2 on the load have been taken into account. For lifting of loads with large sail areas and/or high wind resistance coefficients the maximum wind speed as stated in the load charts has to be reduced.
3. The lifting capacities stated are valid for lifting operation only (corresponding with crane classification according to ISO 4301-1, crane group A1).
4. Lifting capacities are given in kip.
5. The weight of the hook blocks and hooks is part of the load and therefore it must be deducted from the lifting capacities.
6. Working radii are measured from the slewing centre.
7. The stated lengths of the telescopic boom are maximum values and may deviate slightly.
8. The lifting capacities given for the telescopic boom apply if the folding jib is removed.
9. Subject to modification of lifting capacities.
10. Lifting capacities above 153,200 lb / 181,200 lb only with additional pulley block/special equipment.
11. The data of this brochure serves only for general information. All information is provided without warranty. Instructions for the correct commissioning of the crane please take from the operation manual and the load chart book.
12. The pictures contain also accessories and special equipment not included in the standard scope of delivery.

## Remarques

1. La capacité de charge ne doit pas dépasser 85 % de la charge de basculement conformément à ASME B 30.5. La structure métallique de la grue est conforme à EN 13000 et ASME B 30.5.
2. Une vitesse de vent de 30 ft/s (9 m/s, 20 mph) minimum, une surface de prise au vent de 1 m<sup>2</sup> par tonne ainsi qu'un coefficient de résistance au vent de la charge 1,2 sont pris en compte pour le calcul des tableaux de charge. Lorsque des charges ayant une surface de prise au vent et/ou un coefficient de résistance au vent plus élevé(e)s) sont levées, la vitesse de vent maximale indiquée dans les tableaux de charge doit être réduite.
3. Forces de levage pour application de grue de montage (correspond à la classification de grues selon ISO 4301-1, groupe de grues A1).
4. Les charges sont indiquées en kip.
5. Le poids du crochet de levage resp. de la moufle à crochet est une partie de la charge et doit donc être déduit de la capacité de charge.
6. Les portées sont calculées à partir de l'axe de rotation.
7. Les longueurs indiquées pour la flèche télescopique sont des valeurs maximales et peuvent légèrement varier dans la réalité.
8. Les charges indiquées pour la flèche télescopique sont valables lorsque la fléchette pliante est démontée.
9. Charges données sous réserve de modification.
10. Forces de levage plus de 153,200 lb / 181,200 lb seulement avec moufle additionnel/equipement supplémentaire.
11. Les données de cette brochure sont données à titre informatif. Ces renseignements sont sans garantie. Les consignes relatives à la bonne mise en service de la grue sont disponibles dans le manuel d'utilisation et le manuel de tableaux de charge.
12. Les figures contiennent également des accessoires et des équipements spéciaux non inclus de série dans la livraison.

# Customer Service

Personal. Competent. Reliable.  
Personnalisé. Compétent. Fiable.



To ensure your Liebherr remains a Liebherr.

- Commission and training by experienced service technicians
- Worldwide service network with over 80 branches
- 24/7 technical support worldwide
- Fast availability of spare parts
- Attractive packages for maintenance and service

De sorte que votre Liebherr reste une Liebherr.

- Mise en route et formation effectuées par des techniciens qualifiés
- Service-Après-Vente Mondial représenté par plus de 80 correspondants
- Assistance Technique 24/24 et 7/7 jours
- Rapide disponibilité des pièces de rechanges
- Kits d'entretiens pour révisions et maintenances à un prix attractif

## Proposition 65



**WARNING:** This product can expose you to chemicals, including exhaust emissions, including lead and lead compounds, which are known to the State of California to cause cancer, birth defects or other reproductive harm.  
For more information see: [www.P65warnings.ca.gov/diesel](http://www.P65warnings.ca.gov/diesel)

Änderungen vorbehalten · Subject to modification · Sous réserve de modifications · Con riserva di modifiche · Salvo modificaciones · Возможны изменения

Liebherr-Werk Ehingen GmbH · Postfach 1361 · 89582 Ehingen, Germany  
+49 73 91 5 02-0 · [www.liebherr.com](http://www.liebherr.com)

Get Your  
Contact



Printed in Germany (1)  
lwe-tg-284-01-us02-2021