

GR-800XL-4

80 US TON MAX. CRANE CAPACITY

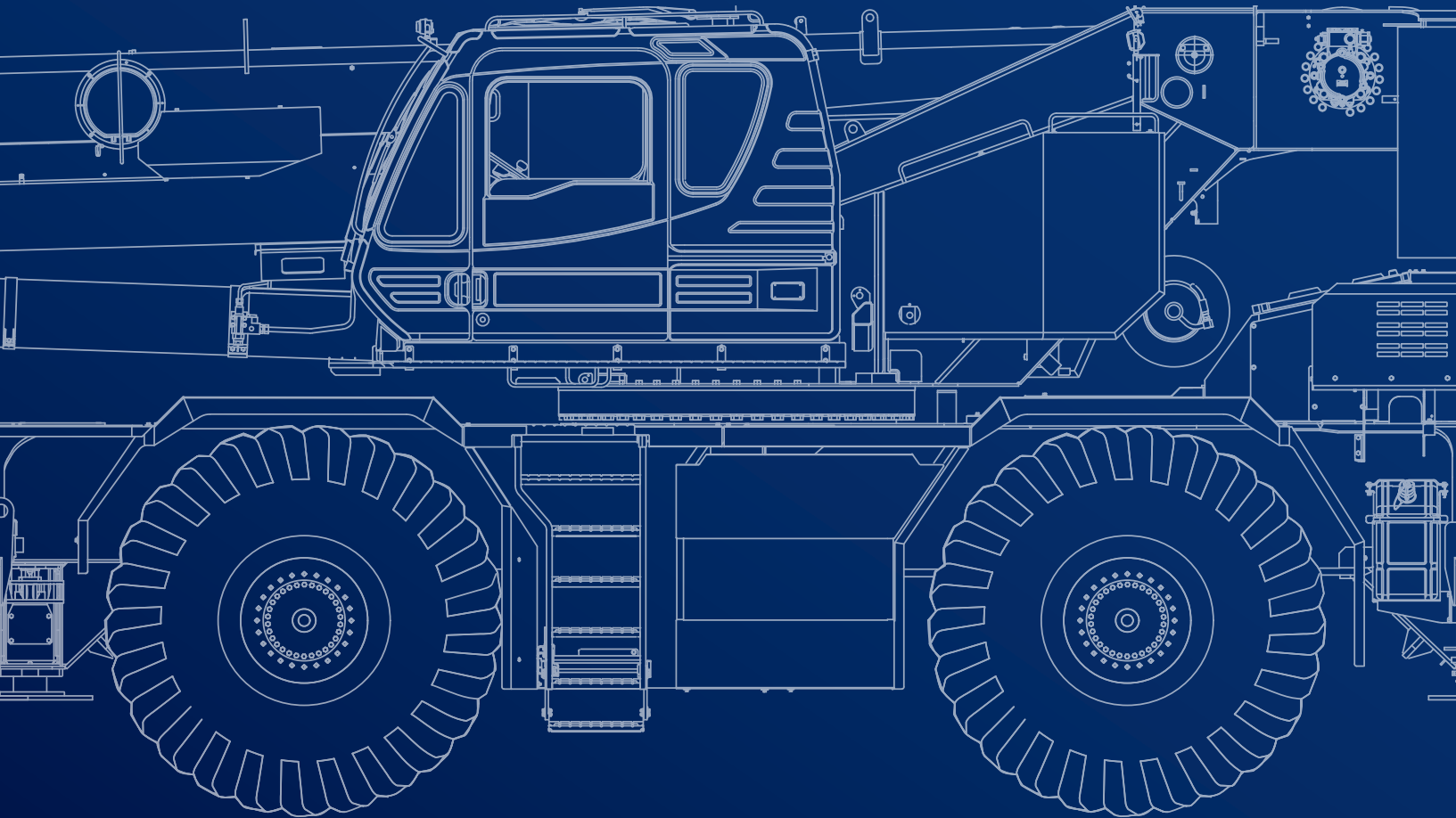

February 2023. Unless otherwise specified, all information in this brochure refers to a standard crane equipment, and it is intended as general information only. No liability is assumed. Errors reserved. Product specifications and prices are subject to changes without notice. The photographs and/or drawings in this brochure are for illustrative purposes only. For correct and safe crane operation, the original operating manual and lifting capacity charts are essential. Failure to follow the corresponding Operator's Manual when using our equipment or failure to otherwise act responsibly may result in property damage, serious injury or death. The sole warranty applicable with respect to our equipment is the standard warranty as per general terms and conditions of sales and service (ask your local Tadano dealer for details), and Tadano makes no other warranty, express or implied. All rights reserved. Any use of the trademarks, logos, brand names and model names used herein is prohibited.

© Tadano Ltd. 2023

Contents

Specifications	5
Vehicle dimensions	6-7
General dimensions	7
Off-road driving	9
Axle weight distribution chart	10
Speeds and gradeability	10
Steering.....	10
Operation	11
Main boom	12
Slewing	12
Hoist	12
Outrigger cylinders	12
Hook blocks	12
Line speeds and pulls	13
Drum wire rope capacities	13
Drum dimensions	13
MB: Main boom.....	14-19
FJ: Folding swing-away jib.....	20-26
Notes to Lifting Capacity	27
Warning and Operating Instructions for on Rubber Lifting Capacities	28
Notes for Load Moment Indicator (AML-E2).....	28
Technical Description	29
Crane specifications.....	30-31
Carrier specifications.....	31
Standard equipment.....	32-33
Optional equipment.....	33

Key

	Counterweight		Rope diameter
	Lifting capacities on outriggers · 360°		Rope length
	Radius		Hook block
	Main boom		Number of lines
	Main boom length		Number of sheaves in hook block
	Folding swing-away jib		Line pulls available
	Free on wheels		Possible load of hook block
	Tires		Weight of hook block
	Hook block		Distance head sheave axle – hook ground
	Hoist		Max. outrigger load
	Travel speed		Length of stroke (support cylinders)
	Gradeability		Base machine
	Working speeds		Gross vehicle weight
	Rope		Weight on front axle
	Base jib		Weight on rear axle
	Top jib		Wire rope layer
	Boom telescoping		Total wire rope
	Boom elevation		Smart Chart: Smart crane control system for main boom and rooster sheave operation enabling higher lifting capacities especially over outriggers. Enables safe use of the full capacity of the crane even in asymmetric outrigger configurations. Visualization of full working area in operator cabin. In-cab lift simulation.
	Slewing		
	Max. line pull		

SPECIFICATIONS

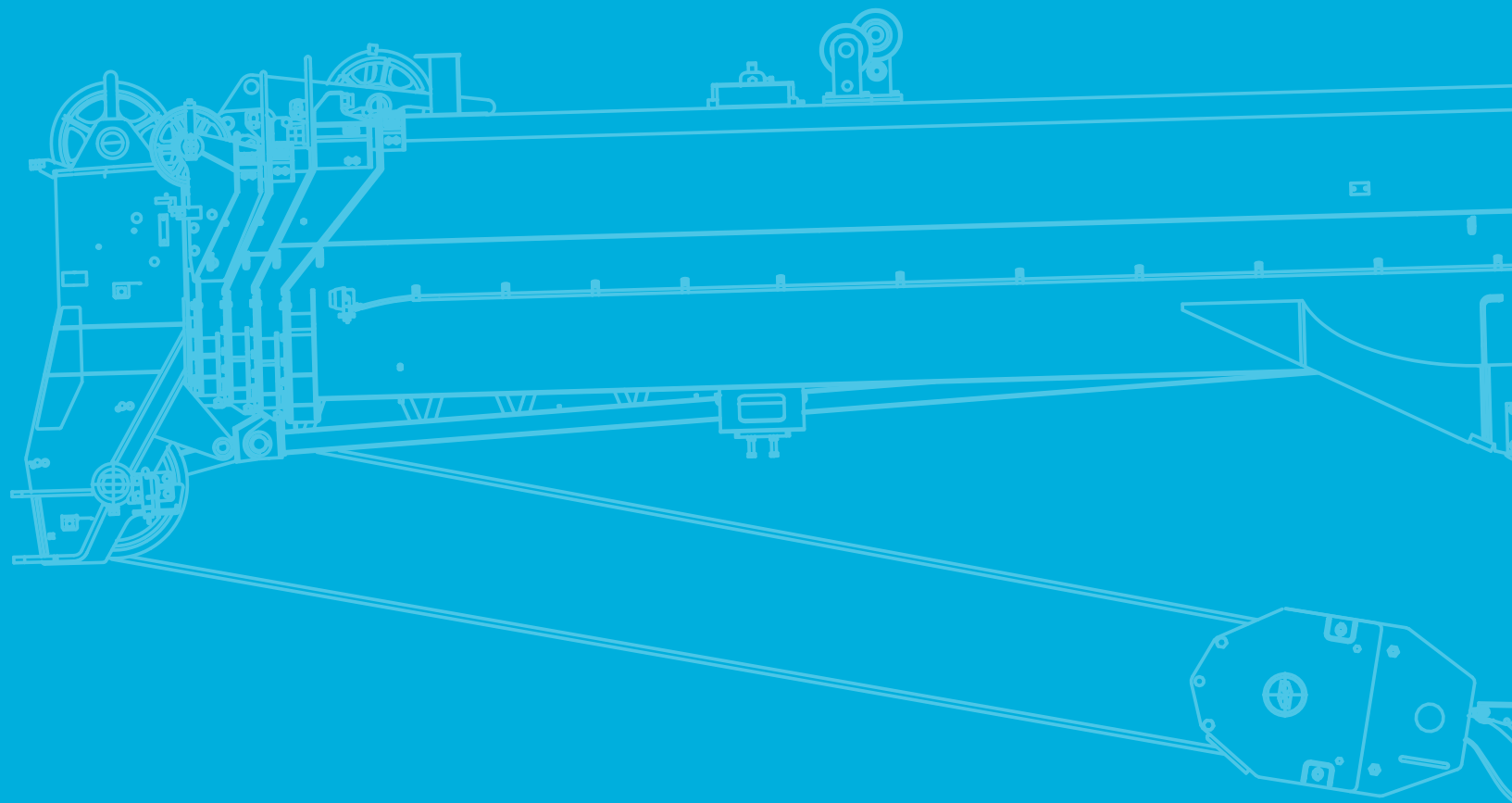

Specifications

Vehicle dimensions

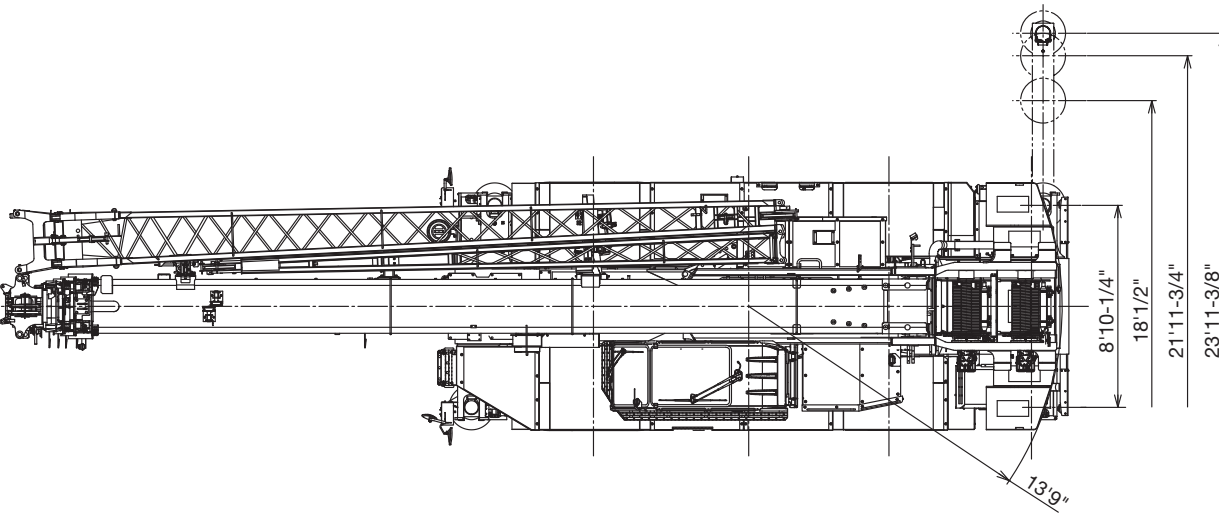
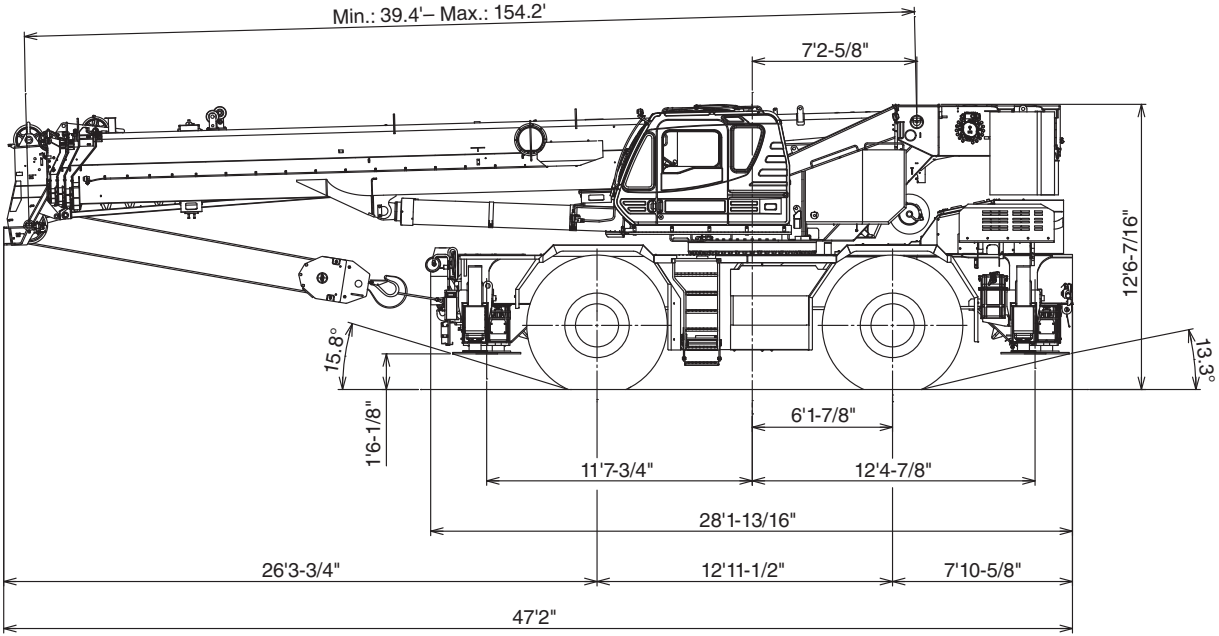

Dimension is with boom angle at -1.6 degree.

Specifications

Vehicle dimensions

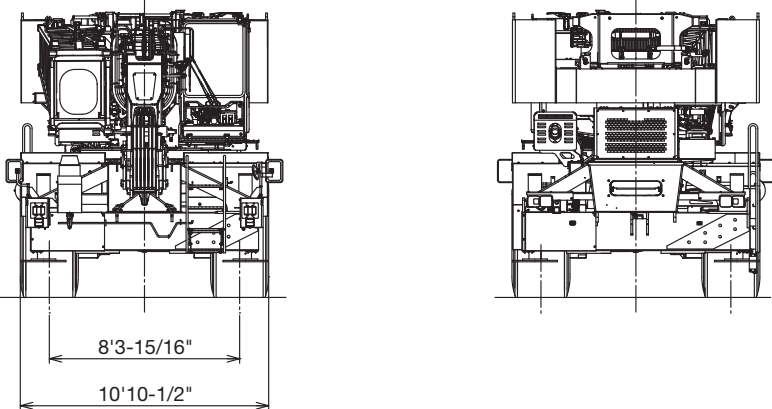

General dimensions







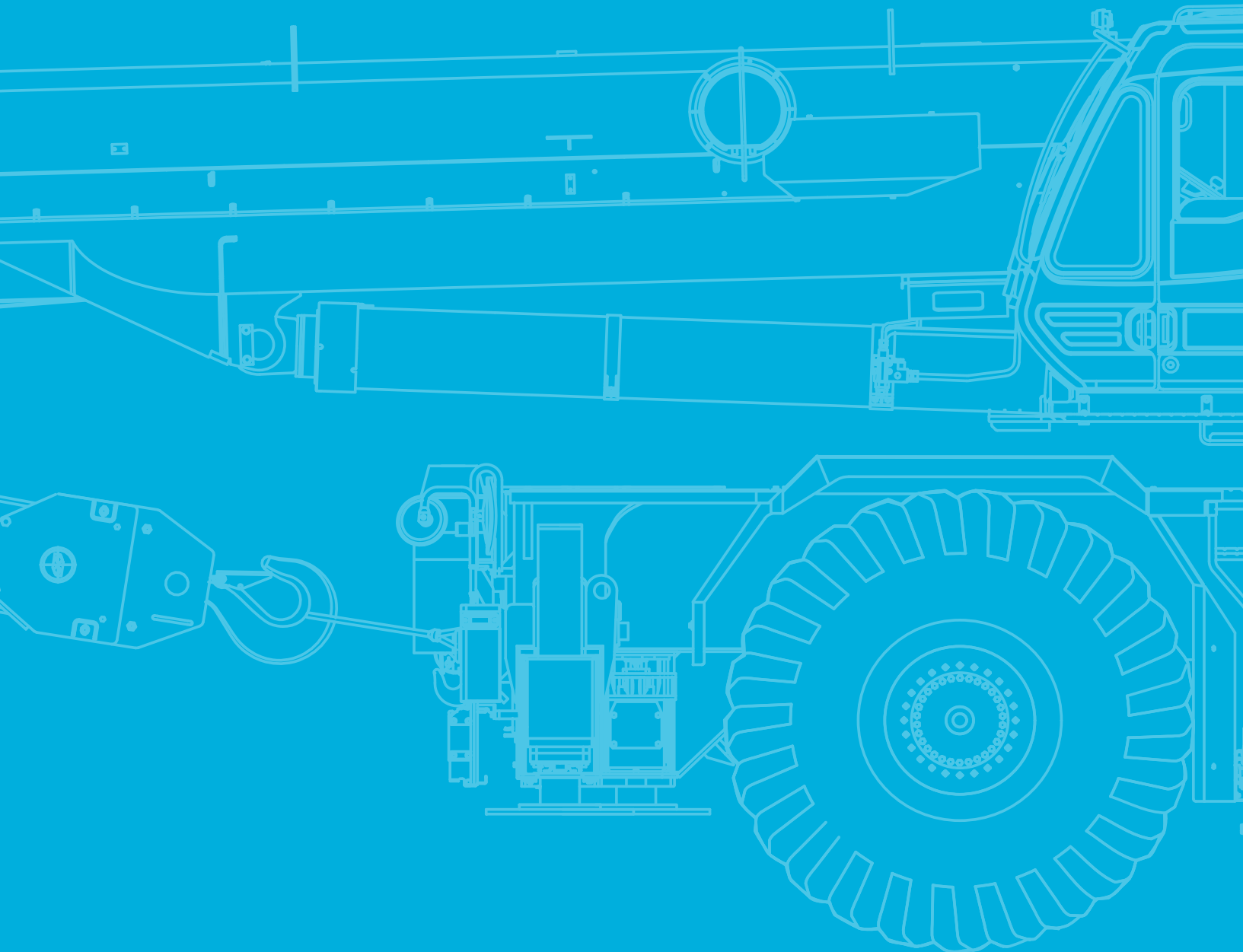

Overall length	approx. 47' 2"
Overall width	approx. 10' 10-1/2"
Overall height	approx. 12' 6-7/16"
4 wheel steer*	22' 4"
2 wheel steer*	35' 9-3/32"

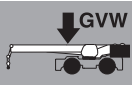
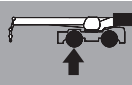

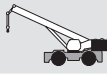
* Turning radius (29.5-25 tires)



TECHNICAL DATA FOR OFF-ROAD DRIVING

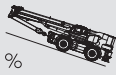

Off-road driving

Axle weight distribution chart			
			
	99,800 lb	54,960 lb	44,840 lb
Remove:			
 7.3 ton	-360 lb	-550 lb	190 lb
 80 ton	-1,200 lb	-2,200 lb	1,010 lb
 Top jib	-740 lb	-990 lb	250 lb
 Base jib	-1,910 lb	-3,760 lb	1,850 lb
	-9,600 lb	4,240 lb	-13,830 lb
Add:			
Auxiliary power unit (option)	780 lb	480 lb	300 lb

Speeds and gradeability	
	29.5-25 34PR
 %	79 % at stall 57 % Machine should be operated within the limit of engine crankcase design (30°: Cummins B6.7)
	22 mph

Steering	
	4 wheel steer
	2 wheel steer

TECHNICAL DATA FOR OPERATION

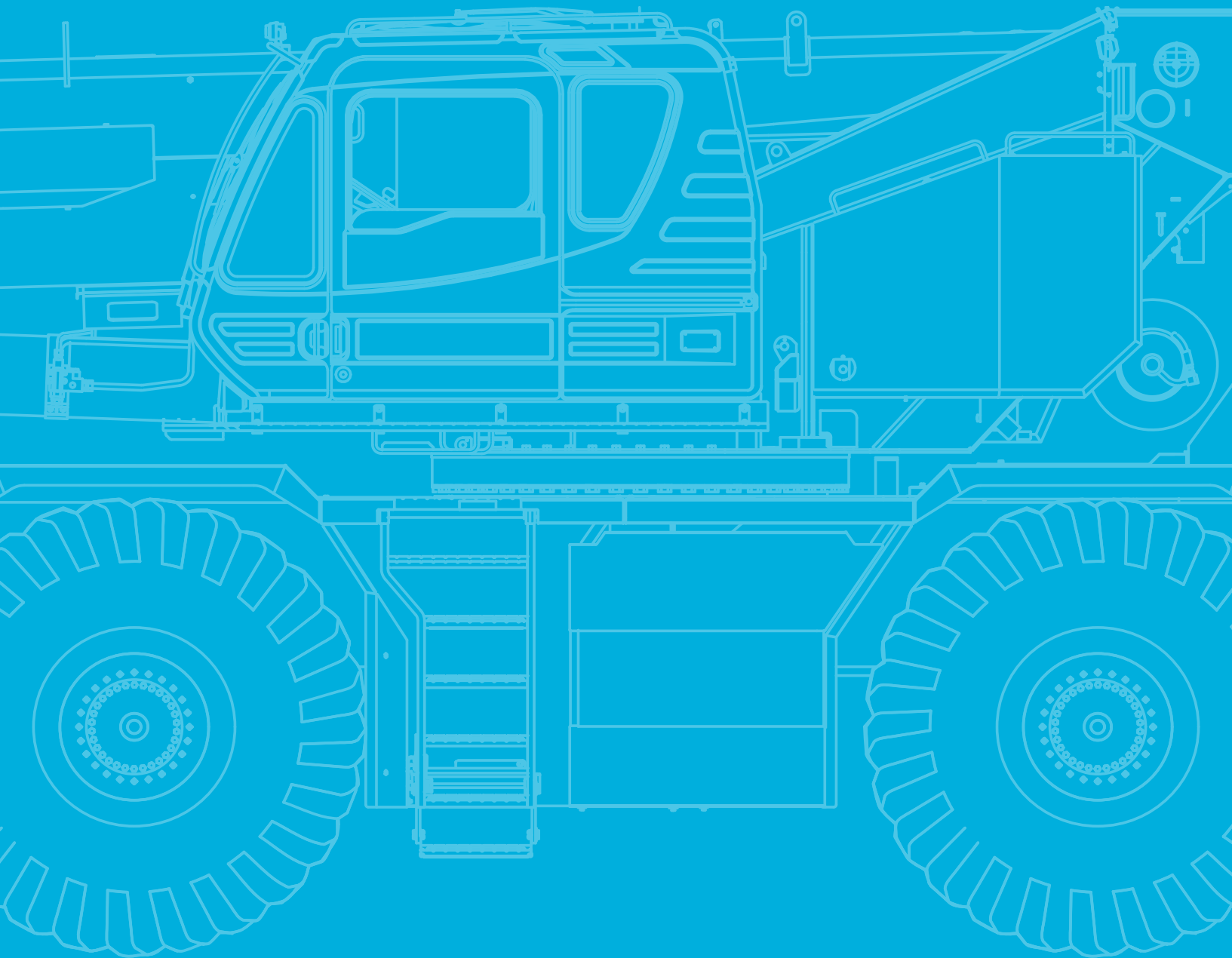

Operation







Main boom

	approx. 142 s (39.4 ft - 154.2 ft)		-1.5° - 80.5° approx. 46 s (20° - 60°)
---	------------------------------------	---	---



Slewing

	1.5 min ⁻¹
---	-----------------------





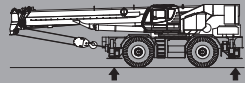

Hoist

				
	526 ft/min	14,600 lb	3/4"	830'
	526 ft/min	14,600 lb	3/4"	830'

Outrigger cylinders

		
	112,500 lb	112,500 lb
	26.4"	26.4"



Hook Blocks

					
7.3 ton	14,500 lb	-	1	360 lb	7.7 ft
80 ton	160,000 lb	6	12	1,200 lb	8.1 ft

Operation

Line speeds and pulls

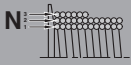
Main or auxiliary hoist - 14'-1/4" drum

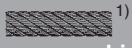
 N	 low		 high	
	low	high	low	high
1	278 ft/min.	387 ft/min.	20,000 lb	14,400 lb
2	302 ft/min.	421 ft/min.	18,100 lb	13,000 lb
3	327 ft/min.	456 ft/min.	16,600 lb	11,900 lb
4	352 ft/min.	491 ft/min.	15,300 lb	10,900 lb
5	377 ft/min.	526 ft/min.	14,100 lb	10,100 lb
6	402 ft/min.	560 ft/min.	13,200 lb	9,400 lb
7 ³⁾	427 ft/min.	595 ft/min.	12,300 lb	8,800 lb

Maximum permissible line pull wire strength 14,600 lb.



1) Line speed based only on hook block, not loaded.

2) Developed by machinery with each layer of wire rope, but not based on rope strength or other limitation in machinery or equipment.

3) Seventh layer of wire rope are not recommended for hoisting operations.

Drum wire rope capacities

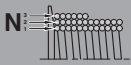
Main and auxiliary drum grooved lagging 3/4" wire rope

 N		 Σ
1	128.0 ft	128.0 ft
2	139.4 ft	267.4 ft
3	150.9 ft	418.3 ft
4	162.1 ft	580.4 ft
5	173.9 ft	754.3 ft
6	185.4 ft	939.6 ft
7	196.9 ft	1,136.5 ft

Drum dimensions

Root diameter	14-1/4"
Length	26-13/16"
Flange diameter	25-7/8"

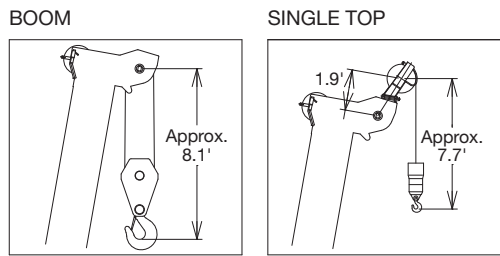
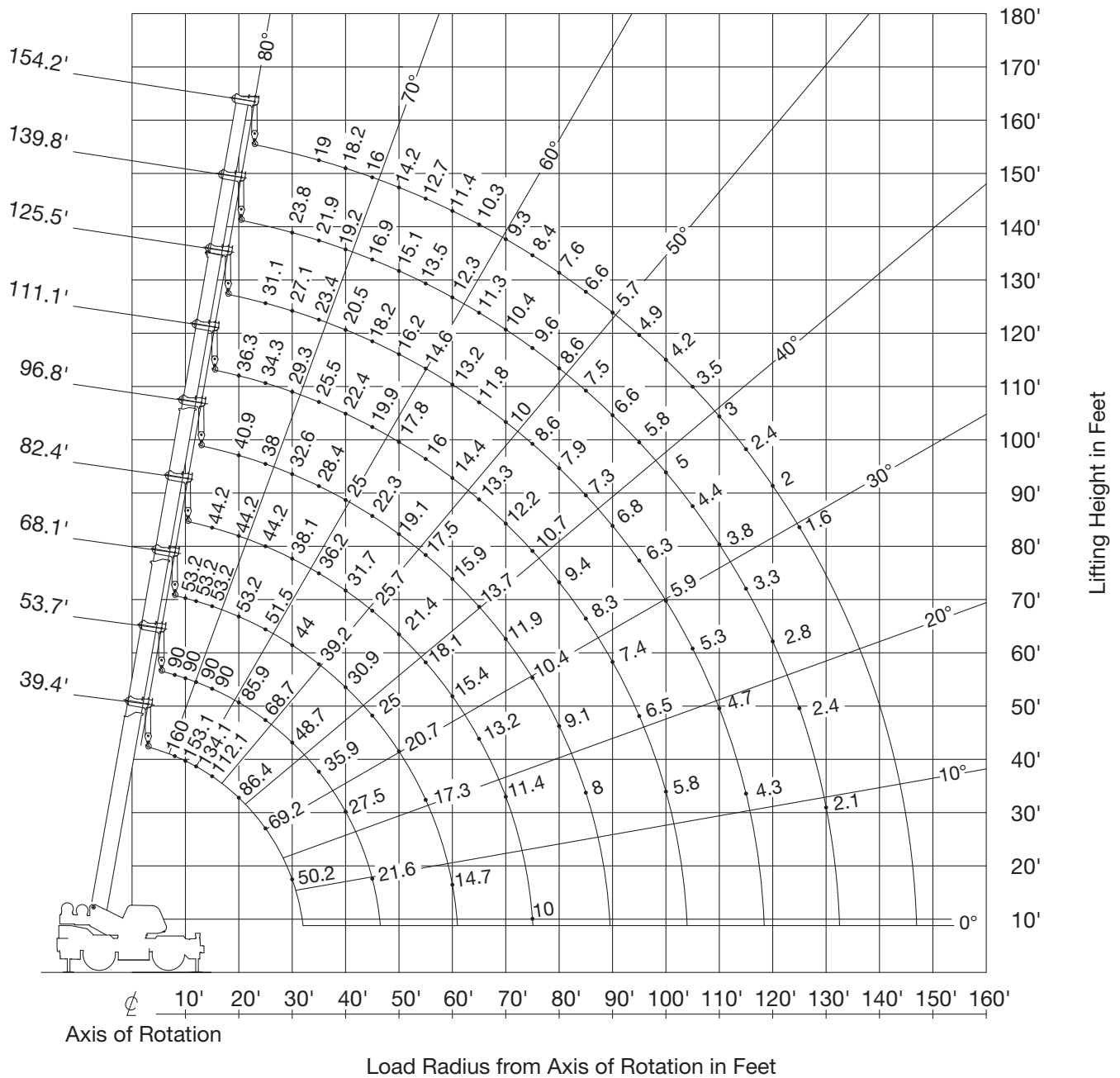

NOTE:

Boom geometry shown is for unloaded condition and machine standing level on firm supporting surface. Boom deflection and subsequent radius and boom angle change must be accounted for when applying load to hook. When boom length is same as telescoping mode 1 and 2, it show large load.

Operation

Fully extended – 360°

9,600 lb		23' 11-3/8" x 24' 0-5/8"														360°	
ft		39.4'	53.7'	68.1'	68.1'	82.4'	82.4'	96.8'	96.8'	111.1'	111.1'	125.5'	125.5'	139.8'	139.8'	154.2'	ft
		1,000 lb															
8	160,000	90,000	-	-	-	-	-	-	-	-	-	-	-	-	-	-	8
10	153,100	90,000	53,200	41,000	-	-	-	-	-	-	-	-	-	-	-	-	10
12	134,100	90,000	53,200	41,000	-	-	-	-	-	-	-	-	-	-	-	-	12
15	112,100	90,000	53,200	41,000	44,200	36,200	-	-	-	-	-	-	-	-	-	-	15
20	86,400	85,900	53,200	41,000	44,200	36,200	40,900	34,300	36,300	33,300	-	-	-	-	-	-	20
25	69,200	68,700	51,500	41,000	44,200	36,200	38,000	33,800	34,300	30,600	31,100	26,200	-	-	-	-	25
30	50,200	48,700	44,000	41,000	38,100	36,200	32,600	29,400	29,300	26,600	27,100	22,400	23,800	22,300	-	-	30
35	-	35,900	35,100	39,200	33,000	36,200	28,400	26,000	25,500	23,500	23,400	19,500	21,900	20,900	19,000	-	35
40	-	27,500	26,900	30,900	28,300	31,700	25,000	23,200	22,400	21,000	20,500	17,200	19,200	18,500	18,200	-	40
45	-	21,600	21,100	25,000	22,400	25,700	22,300	21,000	19,900	18,900	18,200	15,300	16,900	16,500	16,000	-	45
50	-	-	16,800	20,700	18,100	21,400	18,900	19,100	17,800	17,200	16,200	13,700	15,100	14,900	14,200	-	50
55	-	-	13,500	17,300	14,900	18,100	15,600	17,500	16,000	15,700	14,600	12,300	13,500	13,500	12,700	-	55
60	-	-	10,900	14,700	12,200	15,400	13,000	15,900	13,500	14,400	13,200	11,200	12,100	12,300	11,400	-	60
65	-	-	-	-	10,100	13,200	10,900	13,700	11,400	13,300	11,800	10,200	11,000	11,300	10,300	-	65
70	-	-	-	-	8,400	11,400	9,200	11,900	9,700	12,200	10,000	9,300	10,000	10,400	9,300	-	70
75	-	-	-	-	6,900	10,000	7,700	10,400	8,200	10,700	8,600	8,600	8,800	9,600	8,400	-	75
80	-	-	-	-	-	-	6,400	9,100	7,000	9,400	7,300	7,900	7,600	8,600	7,600	-	80
85	-	-	-	-	-	-	5,400	8,000	5,900	8,300	6,200	7,300	6,500	7,500	6,600	-	85
90	-	-	-	-	-	-	-	-	5,000	7,400	5,300	6,800	5,600	6,600	5,700	-	90
95	-	-	-	-	-	-	-	-	4,100	6,500	4,500	6,300	4,700	5,800	4,900	-	95
100	-	-	-	-	-	-	-	-	3,400	5,800	3,800	5,900	4,000	5,000	4,200	-	100
105	-	-	-	-	-	-	-	-	-	-	3,100	5,300	3,400	4,400	3,500	-	105
110	-	-	-	-	-	-	-	-	-	-	2,600	4,700	2,800	3,800	3,000	-	110
115	-	-	-	-	-	-	-	-	-	-	2,100	4,300	2,300	3,300	2,400	-	115
120	-	-	-	-	-	-	-	-	-	-	-	1,800	2,800	2,000	2,000	-	120
125	-	-	-	-	-	-	-	-	-	-	-	-	1,400	2,400	1,600	-	125
130	-	-	-	-	-	-	-	-	-	-	-	-	-	2,100	-	-	130
		0°	0°	0°	0°	0°	0°	0°	0°	0°	0°	0°	0°	13°	0°	33°	

Telescopic conditions (%)

1)	1, 2	1	1	2	1	2	1	2	1	2	1	2	1	2	1, 2	1)	
	2.	0	50	100	0	100	0	100	0	100	0	100	0	100	50	100	2.
	3.	0	0	0	33	16	50	33	67	50	83	67	100	83	100	100	3.
	4.	0	0	0	33	16	50	33	67	50	83	67	100	83	100	100	4.
	Top	0	0	0	33	16	50	33	67	50	83	67	100	83	100	100	Top

	(ft)	39.4'	53.7'	68.1'	68.1'	82.4'	82.4'	96.8'	96.8'	111.1'	111.1'	125.5'	125.5'	139.8'		
	(ft)	32.5	46.8	61.1	61.0	75.3	75.3	89.4	89.5	103.6	103.3	117.8	117.3	131.4		
	²⁾ (lb)	25,900	15,100	8,900	12,500	6,200	9,300	4,400	7,100	3,000	5,400	1,900	3,700	2,000		
1)		1, 2	1	1	2	1	2	1	2	1	2	1	2	2		1)

1) Telescopic mode 2) Loaded boom angle (°)

NOTE:

The lifting capacity data stored in the LOAD MOMENT INDICATOR (AML-E2) is based on the standard number of parts of line listed in the chart. Standard number of parts of line for each boom length should be according to the following table:

	(ft)	39.4'	39.4' to 53.7'	53.7' to 154.2'	Single top jib
1)		1, 2	1	2	1, 2
		12	8	4	4
					1

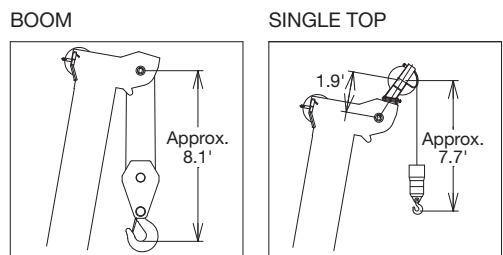
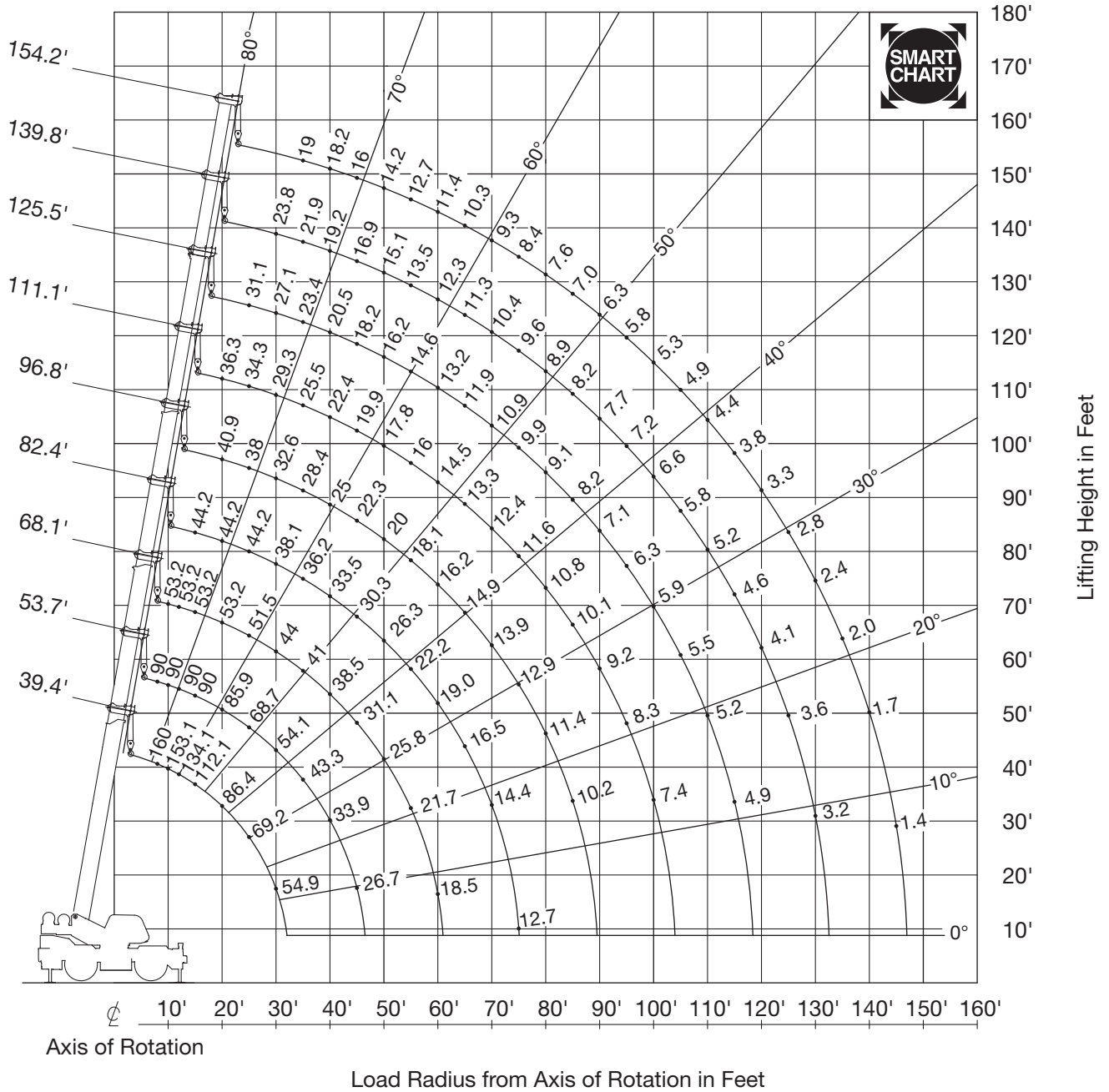

NOTE:

Boom geometry shown is for unloaded condition and machine standing level on firm supporting surface. Boom deflection and subsequent radius and boom angle change must be accounted for when applying load to hook. When boom length is same as telescoping mode 1 and 2, it show large load.

Fully extended – 360° – Smart Chart

9,600 lb		23' 11-3/8" x 24' 0-5/8"														360°	
ft		39.4'	53.7'	68.1'	68.1'	82.4'	82.4'	96.8'	96.8'	111.1'	111.1'	125.5'	125.5'	139.8'	139.8'	154.2'	ft
		1,000 lb															
8	160,000	90,000	-	-	-	-	-	-	-	-	-	-	-	-	-	-	8
10	153,100	90,000	53,200	41,000	-	-	-	-	-	-	-	-	-	-	-	-	10
12	134,100	90,000	53,200	41,000	-	-	-	-	-	-	-	-	-	-	-	-	12
15	112,100	90,000	53,200	41,000	44,200	36,200	-	-	-	-	-	-	-	-	-	-	15
20	86,400	85,900	53,200	41,000	44,200	36,200	40,900	34,300	36,300	33,300	-	-	-	-	-	-	20
25	69,200	68,700	51,500	41,000	44,200	36,200	38,000	33,800	34,300	30,600	31,100	26,200	-	-	-	-	25
30	54,900	54,100	44,000	41,000	38,100	36,200	32,600	29,400	29,300	26,600	27,100	22,400	23,800	22,300	-	-	30
35	-	43,300	38,300	41,000	33,000	36,200	28,400	26,000	25,500	23,500	23,400	19,500	21,900	20,900	19,000	-	35
40	-	33,900	33,100	38,500	29,000	33,500	25,000	23,200	22,400	21,000	20,500	17,200	19,200	18,500	18,200	-	40
45	-	26,700	26,000	31,100	25,700	30,300	22,300	21,000	19,900	18,900	18,200	15,300	16,900	16,500	16,000	-	45
50	-	-	20,900	25,800	22,300	26,300	20,000	19,100	17,800	17,200	16,200	13,700	15,100	14,900	14,200	-	50
55	-	-	17,000	21,700	18,400	22,200	18,100	17,500	16,000	15,700	14,600	12,300	13,500	13,500	12,700	-	55
60	-	-	13,900	18,500	15,300	19,000	16,200	16,100	14,500	14,400	13,200	11,200	12,100	12,300	11,400	-	60
65	-	-	-	-	12,900	16,500	13,700	14,900	13,200	13,300	11,900	10,200	11,000	11,300	10,300	-	65
70	-	-	-	-	10,800	14,400	11,700	13,900	12,100	12,400	10,900	9,300	10,000	10,400	9,300	-	70
75	-	-	-	-	9,100	12,700	10,000	12,900	10,500	11,600	9,900	8,600	9,100	9,600	8,400	-	75
80	-	-	-	-	-	-	8,500	11,400	9,100	10,800	9,100	7,900	8,300	8,900	7,600	-	80
85	-	-	-	-	-	-	7,300	10,200	7,800	10,100	8,200	7,300	7,600	8,200	7,000	-	85
90	-	-	-	-	-	-	-	-	6,800	9,200	7,100	6,800	6,900	7,700	6,300	-	90
95	-	-	-	-	-	-	-	-	5,800	8,300	6,200	6,300	6,400	7,200	5,800	-	95
100	-	-	-	-	-	-	-	-	5,000	7,400	5,400	5,900	5,600	6,600	5,300	-	100
105	-	-	-	-	-	-	-	-	-	-	4,600	5,500	4,900	5,800	4,900	-	105
110	-	-	-	-	-	-	-	-	-	-	4,000	5,200	4,200	5,200	4,400	-	110
115	-	-	-	-	-	-	-	-	-	-	3,400	4,900	3,600	4,600	3,800	-	115
120	-	-	-	-	-	-	-	-	-	-	-	-	3,100	4,100	3,300	-	120
125	-	-	-	-	-	-	-	-	-	-	-	-	2,700	3,600	2,800	-	125
130	-	-	-	-	-	-	-	-	-	-	-	-	2,300	3,200	2,400	-	130
135	-	-	-	-	-	-	-	-	-	-	-	-	-	-	2,000	-	135
140	-	-	-	-	-	-	-	-	-	-	-	-	-	-	1,700	-	140
145	-	-	-	-	-	-	-	-	-	-	-	-	-	-	1,400	-	145

Telescopic conditions (%)

1)	1, 2	1	1	2	1	2	1	2	1	2	1	2	1	2	1, 2	1)
2.)	0	50	100	0	100	0	100	0	100	0	100	0	100	50	100	2.
3.)	0	0	0	33	16	50	33	67	50	83	67	100	83	100	100	3.
4.)	0	0	0	33	16	50	33	67	50	83	67	100	83	100	100	4.
Top	0	0	0	33	16	50	33	67	50	83	67	100	83	100	100	Top

(ft)	39.4'	53.7'	68.1'	68.1'	82.4'	82.4'	96.8'	96.8'	111.1'	111.1'	125.5'	125.5'	139.8'	139.8'	
(ft)	32.5	46.8	61.1	61.0	75.3	75.3	89.4	89.5	103.7	103.4	117.8	117.2	131.9	131.3	
2) (lb)	25,900	15,100	8,900	12,500	6,200	9,300	4,500	7,100	3,100	5,600	2,200	4,200	1,400	2,600	
1)	1, 2	1	1	2	1	2	1	2	1	2	1	2	1	2	1)

1) Telescopic mode 2) Loaded boom angle (°)

NOTE:

The lifting capacity data stored in the LOAD MOMENT INDICATOR (AML-E2) is based on the standard number of parts of line listed in the chart. Standard number of parts of line for each boom length should be according to the following table:

(ft)	39.4'	39.4' to 53.7'	53.7' to 154.2'	Single top jib
1)	1, 2	1	2	1, 2
	12	8	4	4





Smart Chart

On rubber stationary

9,600 lb		0°*			
	39.4'	68.1'	82.4'	96.8'	
ft	1,000 lb				
10	65,500	-	-	-	
12	56,700	-	-	-	
15	46,800	-	-	-	
20	35,200	37,300	26,500	-	
25	22,900	26,100	26,200	26,000	
30	-	19,000	19,600	19,700	
35	-	14,400	14,900	15,300	
40	-	11,100	11,600	11,900	
45	-	8,600	9,100	9,500	
50	-	6,700	7,200	7,500	
55	-	5,200	5,700	6,000	
60	-	4,000	4,400	4,700	
65	-	-	3,400	3,700	
70	-	-	2,600	2,900	
75	-	-	1,900	2,100	
80	-	-	-	1,500	
	0°	0°	0°	20°	

Telescopic conditions (%)



1)	1, 2	2	2	2
2.)	0	0	0	0
3.)	0	33	50	67
4.)	0	33	50	67
Top	0	33	50	67

	(ft)	39.4'	68.1'	82.4'
	(ft)	32.5	61.3	75.3
	²⁾ 0° (lb)	13,400	3,000	1,900

- 1) Telescopic mode
- 2) Loaded boom angle (°)
- * over front

NOTE:



The lifting capacity data stored in the LOAD MOMENT INDICATOR (AML-E2) is based on the standard number of parts of line listed in the chart. Standard number of parts of line for on-rubber operation should be according to the chart.

	(ft)	39.4'	42.0' to 96.8'	Single top jib
		6	4	1

9,600 lb		360°			
	39.4'	68.1'	82.4'	96.8'	
ft	1,000 lb				
10	38,200	-	-	-	
12	31,400	-	-	-	
15	20,900	-	-	-	
20	11,400	14,800	15,500	-	
25	6,300	9,500	10,200	10,600	
30	-	6,200	6,800	7,200	
35	-	3,900	4,500	4,800	
40	-	2,200	2,800	3,200	
45	-	-	1,500	1,900	
50	-	-	-	-	
55	-	-	-	-	
60	-	-	-	-	
65	-	-	-	-	
70	-	-	-	-	
75	-	-	-	-	
80	-	-	-	-	
	0°	44°	52°	57°	

Telescopic conditions (%)

1)	1, 2	2	2	2
2.)	0	0	0	0
3.)	0	33	50	67
4.)	0	33	50	67
Top	0	33	50	67

	(ft)	39.4'
	(ft)	32.5
	²⁾ 0° (lb)	3,700

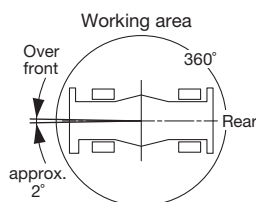

Operation

MB

On rubber creep

9,600 lb		0°*			
	39.4'	68.1'	82.4'	96.8'	
ft	1,000 lb				
10	48,500	-	-	-	
12	41,800	-	-	-	
15	33,900	-	-	-	
20	24,900	27,100	26,500	-	
25	18,800	21,200	21,600	21,800	
30	-	17,000	17,400	17,600	
35	-	13,700	14,100	14,400	
40	-	11,100	11,600	11,800	
45	-	8,600	9,100	9,500	
50	-	6,700	7,200	7,500	
55	-	5,200	5,700	6,000	
60	-	4,000	4,400	4,700	
65	-	-	3,400	3,700	
70	-	-	2,600	2,900	
75	-	-	1,900	2,100	
80	-	-	-	1,500	
	0°	0°	0°	20°	

Telescopic conditions (%)

1)	1, 2	2	2	2
	2.	0	0	0
	3.	0	33	50
	4.	0	33	50
	Top	0	33	50

	(ft)	39.4'	68.1'	82.4'
	(ft)	32.5	61.3	75.3
	²⁾ (lb)	11,200	3,000	1,900

1) Telescopic mode

2) Loaded boom angle (°)

* over front

NOTE:

The lifting capacity data stored in the LOAD MOMENT INDICATOR (AML-E2) is based on the standard number of parts of line listed in the chart. Standard number of parts of line for on-rubber operation should be according to the chart.

	(ft)	39.4'	42.0' to 96.8'	Single top jib
		6	4	1

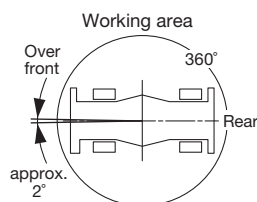

Operation

Fully extended – 360°

9,600 lb					23' 11-3/8" x 24' 0-5/8"					360°												
		154.2' + 33.2'					154.2' + 58.1'															
		3.5°			25°			45°					3.5°			25°			45°			
ft		1,000 lb									ft		1,000 lb									
40	10,400	-	-	-	-	-	-	-	-	-	40	-	-	-	-	-	-	-	-	-	-	-
45	10,400	-	-	-	-	-	-	-	-	-	45	-	-	-	-	-	-	-	-	-	-	-
50	10,400	-	-	-	-	-	-	-	-	-	50	6,700	-	-	-	-	-	-	-	-	-	-
55	10,400	10,200	-	-	-	-	-	-	-	-	55	6,700	-	-	-	-	-	-	-	-	-	-
60	10,400	10,200	-	-	-	-	-	-	-	-	60	6,700	-	-	-	-	-	-	-	-	-	-
65	10,400	10,200	8,800	-	-	-	-	-	-	-	65	6,700	-	-	-	-	-	-	-	-	-	-
70	9,500	9,600	8,800	8,800	-	-	-	-	-	-	70	6,700	-	-	-	-	-	-	-	-	-	-
75	8,600	8,800	8,400	8,400	-	-	-	-	-	-	75	6,700	6,000	-	-	-	-	-	-	-	-	-
80	7,700	8,000	8,000	8,000	-	-	-	-	-	-	80	6,700	5,800	-	-	-	-	-	-	-	-	-
85	7,000	7,300	7,400	7,400	-	-	-	-	-	-	85	6,700	5,700	4,800	-	-	-	-	-	-	-	-
90	6,300	6,600	6,700	6,700	-	-	-	-	-	-	90	6,500	5,500	4,700	-	-	-	-	-	-	-	-
95	5,400	6,000	6,200	6,200	-	-	-	-	-	-	95	5,700	5,400	4,600	-	-	-	-	-	-	-	-
100	4,600	5,400	5,600	5,600	-	-	-	-	-	-	100	4,900	5,300	4,500	-	-	-	-	-	-	-	-
105	3,900	4,700	5,100	5,100	-	-	-	-	-	-	105	4,300	5,200	4,400	-	-	-	-	-	-	-	-
110	3,300	4,000	4,500	4,500	-	-	-	-	-	-	110	3,700	4,900	4,300	-	-	-	-	-	-	-	-
115	2,800	3,400	3,800	3,800	-	-	-	-	-	-	115	3,100	4,300	4,200	-	-	-	-	-	-	-	-
120	2,300	2,900	3,200	3,200	-	-	-	-	-	-	120	2,600	3,700	4,100	-	-	-	-	-	-	-	-
125	1,900	2,400	2,700	2,700	-	-	-	-	-	-	125	2,200	3,200	3,900	-	-	-	-	-	-	-	-
130	1,400	1,900	2,200	2,200	-	-	-	-	-	-	130	1,800	2,700	3,300	-	-	-	-	-	-	-	-
135	-	1,500	-	-	-	-	-	-	-	-	135	1,400	2,200	2,800	-	-	-	-	-	-	-	-
140	-	-	-	-	-	-	-	-	-	-	140	-	1,800	2,400	-	-	-	-	-	-	-	-
145	-	-	-	-	-	-	-	-	-	-	145	-	1,500	1,900	-	-	-	-	-	-	-	-
150	-	-	-	-	-	-	-	-	-	-	150	-	-	1,500	-	-	-	-	-	-	-	-
1)	1, 2	1, 2	1, 2	1, 2							1)	1, 2	1, 2	1, 2	1, 2							

		139.8' + 33.2'					139.8' + 58.1'															
		3.5°			25°			45°					3.5°			25°			45°			
ft		1,000 lb									ft		1,000 lb									
35	10,400	11,500	-	-	-	-	-	-	-	-	35	-	-	-	-	-	-	-	-	-	-	-
40	10,400	11,500	-	-	-	-	-	-	-	-	40	6,700	-	-	-	-	-	-	-	-	-	-
45	10,400	11,500	-	-	-	-	-	-	-	-	45	6,700	7,200	-	-	-	-	-	-	-	-	-
50	10,400	11,500	10,200	10,900	-	-	-	-	-	-	50	6,700	7,200	-	-	-	-	-	-	-	-	-
55	10,400	11,500	10,200	10,900	8,800	9,100	-	-	-	-	55	6,700	7,200	-	-	-	-	-	-	-	-	-
60	10,400	11,400	10,200	10,600	8,800	9,100	-	-	-	-	60	6,700	7,200	-	-	-	-	-	-	-	-	-
65	10,400	10,400	10,200	9,800	8,800	9,000	-	-	-	-	65	6,700	7,200	6,000	-	-	-	-	-	-	-	-
70	9,900	9,400	10,100	9,100	8,800	8,600	-	-	-	-	70	6,700	7,200	6,000	6,200	-	-	-	-	-	-	-
75	8,900	8,600	9,100	8,500	8,800	8,100	-	-	-	-	75	6,700	7,200	6,000	6,000	4,800	-	-	-	-	-	-
80	8,100	7,900	8,300	7,800	8,400	7,600	-	-	-	-	80	6,700	7,200	6,000	5,900	4,800	4,800	-	-	-	-	-
85	7,400	7,300	7,600	7,300	7,700	7,200	-	-	-	-	85	6,700	7,000	5,800	5,700	4,800	4,800	-	-	-	-	-
90	6,500	6,700	6,900	6,700	7,100	6,700	-	-	-	-	90	6,700	6,400	5,600	5,600	4,700	4,700	-	-	-	-	-
95	5,600	6,200	6,400	6,200	6,500	6,200	-	-	-	-	95	6,000	5,900	5,500	5,400	4,600	4,500	-	-	-	-	-
100	4,800	5,700	5,600	5,800	5,900	5,800	-	-	-	-	100	5,200	5,400	5,400	5,200	4,500	4,500	-	-	-	-	-
105	4,100	5,000	4,800	5,400	5,300	5,400	-	-	-	-	105	4,500	5,000	5,200	5,000	4,400	4,300	-	-	-	-	-
110	3,500	4,300	4,100	4,900	4,500	5,000	-	-	-	-	110	3,900	4,700	5,100	4,700	4,300	4,300	-	-	-	-	-
115	2,900	3,800	3,500	4,300	3,900	4,600	-	-	-	-	115	3,400	4,100	4,500	4,400	4,200	4,200	-	-	-	-	-
120	2,400	3,300	3,000	3,700	3,200	4,000	-	-	-	-	120	2,900	3,600	3,900	4,100	4,100	4,100	-	-	-	-	-
125	2,000	2,800	2,400	3,200	2,700	3,400	-	-	-	-	125	2,400	3,100	3,300	3,800	4,000	3,900	-	-	-	-	-
130	1,500	2,400	2,000	2,800	2,200	-	-	-	-	-	130	2,000	2,700	2,800	3,500	3,400	3,600	-	-	-	-	-
135	1,200	2,000	1,500	2,300	-	-	-	-	-	-	135	1,600	2,300	2,400	3,100	2,900	3,400	-	-	-	-	-
140	-	1,700	1,100	2,000	-	-	-	-	-	-	140	1,300	2,000	2,000	2,600	2,400	3,100	-	-	-	-	-
145	-	1,300	-	1,600	-	-	-	-	-	-	145	-	1,700	1,600	2,300	2,000	2,600	-	-	-	-	-
150	-	-	-	-	-	-	-	-	-	-	150	-	1,400	1,200	1,900	1,600	2,200	-	-	-	-	-
155	-	-	-	-	-	-	-	-	-	-	155	-	1,100	-	1,600	-	1,800	-	-	-	-	-
160	-	-	-	-	-	-	-	-	-	-	160	-	-	-	1,300	-	-	-	-	-	-	-
1)	1	2	1	2	1	2					1)	1	2	1	2	1	2					

1) Telescopic mode

Operation

Fully extended – 360°

9,600 lb								23' 11-3/8" x 24' 0-5/8"								360°							
				125.5' + 33.2'								125.5' + 58.1'											
ft		3.5°		25°		45°		ft		3.5°		25°		45°									
				1,000 lb								1,000 lb											
35	14,600	11,500	-	-	-	-	35	-	-	-	-	-	-	-	-								
40	14,600	11,500	-	-	-	-	40	-	7,200	-	-	-	-	-	-								
45	14,600	11,500	12,600	10,900	-	-	45	8,700	7,200	-	-	-	-	-	-								
50	14,600	11,500	12,600	10,900	-	-	50	8,700	7,200	-	-	-	-	-	-								
55	14,200	11,500	12,500	10,900	10,000	9,100	55	8,700	7,200	-	-	-	-	-	-								
60	12,800	10,500	12,000	10,100	9,800	9,100	60	8,700	7,200	-	-	-	-	-	-								
65	11,500	9,500	11,600	9,300	9,600	8,800	65	8,700	7,200	6,700	6,300	-	-	-	-								
70	10,400	8,600	10,500	8,600	9,400	8,300	70	8,500	7,200	6,400	6,300	-	-	-	-								
75	9,500	7,900	9,600	7,900	9,200	7,800	75	8,100	7,200	6,200	6,100	5,100	4,800	-	-								
80	8,700	7,200	8,800	7,300	8,900	7,300	80	7,800	7,000	6,000	5,900	4,900	4,800	-	-								
85	7,600	6,600	8,100	6,700	8,200	6,700	85	7,500	6,400	5,900	5,700	4,800	4,700	-	-								
90	6,600	6,100	7,400	6,200	7,500	6,200	90	7,200	5,900	5,700	5,600	4,700	4,600	-	-								
95	5,700	5,600	6,400	5,700	6,900	5,700	95	6,300	5,400	5,500	5,300	4,600	4,500	-	-								
100	4,900	5,100	5,600	5,200	6,000	5,300	100	5,500	5,000	5,300	5,000	4,500	4,400	-	-								
105	4,200	4,700	4,800	4,800	5,100	4,900	105	4,800	4,600	5,200	4,700	4,300	4,300	-	-								
110	3,600	4,400	4,100	4,500	4,400	4,500	110	4,200	4,200	5,000	4,400	4,300	4,200	-	-								
115	3,000	4,000	3,500	4,100	3,700	4,200	115	3,600	3,900	4,700	4,100	4,200	4,100	-	-								
120	2,500	3,700	3,000	3,800	-	-	120	3,100	3,600	4,000	3,800	4,100	3,900	-	-								
125	2,100	3,400	2,400	3,500	-	-	125	2,600	3,300	3,500	3,500	4,000	3,600	-	-								
130	1,700	3,200	2,000	3,200	-	-	130	2,200	3,000	3,000	3,200	3,500	3,300	-	-								
135	1,300	2,800	1,500	3,000	-	-	135	1,800	2,800	2,500	3,000	3,000	3,000	-	-								
140	-	2,500	1,100	2,600	-	-	140	1,500	2,600	2,100	2,700	2,400	2,800	-	-								
145	-	2,200	-	-	-	-	145	1,100	2,400	1,700	2,500	-	-	-	-								
150	-	-	-	-	-	-	150	-	2,200	1,300	2,300	-	-	-	-								
155	-	-	-	-	-	-	155	-	2,000	-	2,100	-	-	-	-								
160	-	-	-	-	-	-	160	-	1,700	-	1,900	-	-	-	-								
1)	1	2	1	2	1	2	1)	1	2	1	2	1	2										

1) Telescopic mode

Operation

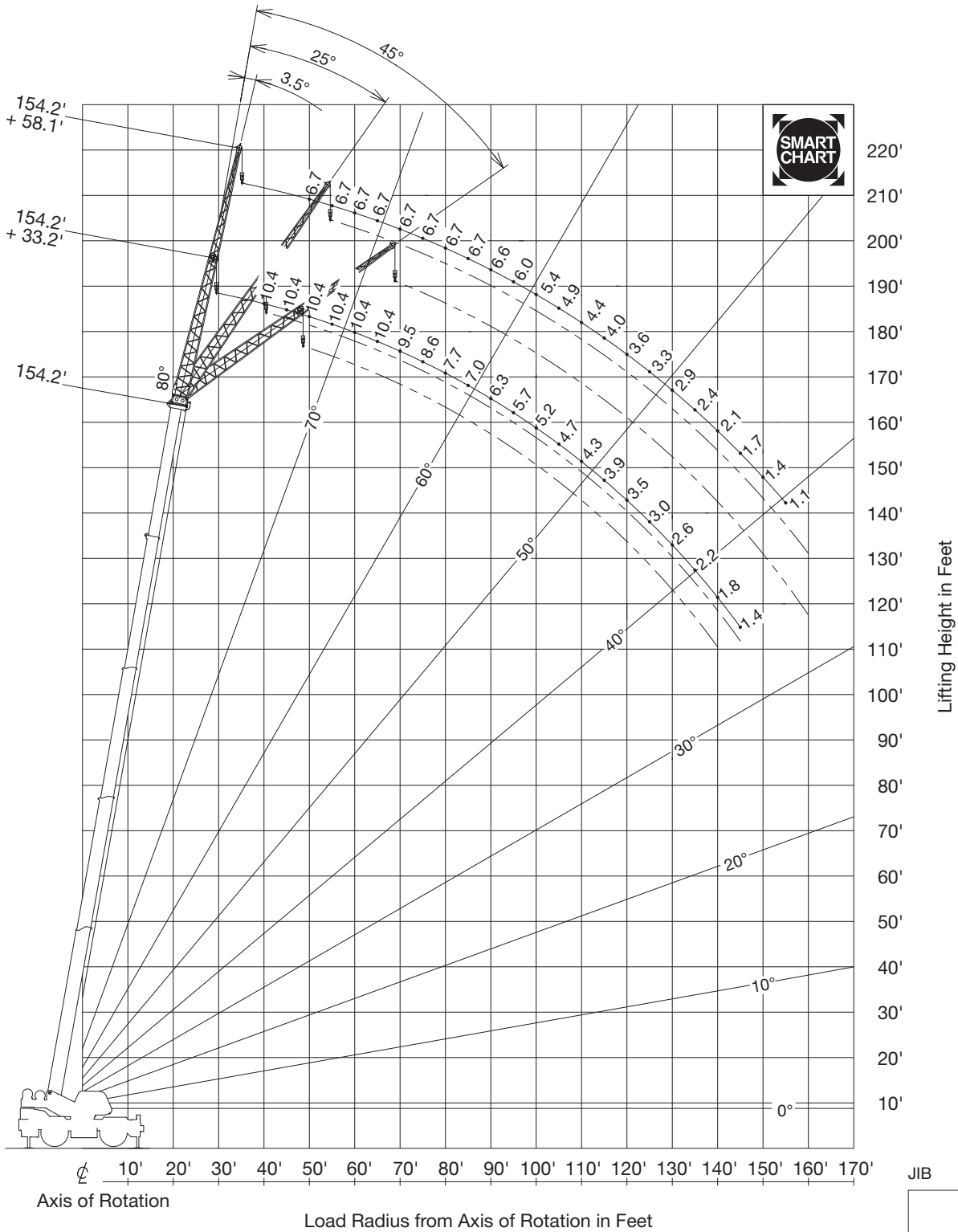

NOTE:

Jib geometry shown is for unloaded condition and machine standing level on firm supporting surface. Boom deflection and subsequent radius and boom angle change must be accounted for when applying load to hook.

Operation

Fully extended – 360° – Smart Chart

9,600 lb				23' 11-3/8" x 24' 0-5/8"				360°			
		154.2' + 33.2'				154.2' + 58.1'					
		3.5°		25°		45°					
ft		1,000 lb						ft		1,000 lb	
40	10,400	-	-	-	-	-	-	40	-	-	-
45	10,400	-	-	-	-	-	-	45	-	-	-
50	10,400	-	-	-	-	-	-	50	6,700	-	-
55	10,400	10,200	-	-	-	-	-	55	6,700	-	-
60	10,400	10,200	-	-	-	-	-	60	6,700	-	-
65	10,400	10,200	8,800	-	-	-	-	65	6,700	-	-
70	9,500	9,600	8,800	-	-	-	-	70	6,700	-	-
75	8,600	8,800	8,400	-	-	-	-	75	6,700	6,000	-
80	7,700	8,000	8,000	-	-	-	-	80	6,700	5,800	-
85	7,000	7,300	7,400	-	-	-	-	85	6,700	5,700	4,800
90	6,300	6,600	6,700	-	-	-	-	90	6,600	5,500	4,700
95	5,700	6,000	6,200	-	-	-	-	95	6,000	5,400	4,600
100	5,200	5,500	5,600	-	-	-	-	100	5,400	5,300	4,500
105	4,700	5,000	5,100	-	-	-	-	105	4,900	5,200	4,400
110	4,300	4,500	4,700	-	-	-	-	110	4,400	4,900	4,300
115	3,900	4,100	4,300	-	-	-	-	115	4,000	4,500	4,200
120	3,500	3,700	3,900	-	-	-	-	120	3,600	4,100	4,100
125	3,000	3,400	3,500	-	-	-	-	125	3,300	3,700	3,900
130	2,600	3,000	3,200	-	-	-	-	130	2,900	3,400	3,600
135	2,200	2,600	2,800	-	-	-	-	135	2,400	3,100	3,300
140	1,800	2,200	2,300	-	-	-	-	140	2,100	2,800	3,000
145	1,400	1,800	-	-	-	-	-	145	1,700	2,400	2,600
150	-	-	-	-	-	-	-	150	1,400	2,100	2,400
155	-	-	-	-	-	-	-	155	1,100	1,700	2,100
160	-	-	-	-	-	-	-	160	-	1,400	1,700
1)	1, 2	1, 2	1, 2					1)	1, 2	1, 2	1, 2

		139.8' + 33.2'					
		3.5°		25°		45°	
ft		1,000 lb					
35	10,400	11,500	-	-	-	-	-
40	10,400	11,500	-	-	-	-	-
45	10,400	11,500	-	-	-	-	-
50	10,400	11,500	10,200	10,900	-	-	-
55	10,400	11,500	10,200	10,900	8,800	9,100	-
60	10,400	11,400	10,200	10,600	8,800	9,100	-
65	10,400	10,400	10,200	9,800	8,800	9,000	-
70	9,900	9,400	10,100	9,100	8,800	8,600	-
75	8,900	8,600	9,100	8,500	8,800	8,100	-
80	8,100	7,900	8,300	7,800	8,400	7,600	-
85	7,400	7,300	7,600	7,300	7,700	7,200	-
90	6,700	6,700	6,900	6,700	7,100	6,700	-
95	6,100	6,200	6,400	6,200	6,500	6,200	-
100	5,600	5,800	5,800	5,800	5,900	5,800	-
105	5,100	5,300	5,300	5,400	5,400	5,400	-
110	4,700	5,000	4,900	5,000	5,000	5,000	-
115	4,300	4,600	4,500	4,700	4,600	4,700	-
120	3,700	4,300	4,100	4,300	4,200	4,300	-
125	3,200	4,000	3,700	4,000	3,800	4,000	-
130	2,700	3,500	3,200	3,700	3,300	3,800	-
135	2,300	3,100	2,700	3,400	-	-	-
140	1,900	2,700	2,200	3,000	-	-	-
145	1,600	2,300	1,800	2,500	-	-	-
150	-	2,000	-	2,200	-	-	-
155	-	1,700	-	1,800	-	-	-
160	-	-	-	-	-	-	-
1)	1	2	1	2	1	2	

		139.8' + 58.1'					
		3.5°		25°		45°	
ft		1,000 lb					
35	-	-	-	-	-	-	-
40	6,700	-	-	-	-	-	-
45	6,700	7,200	-	-	-	-	-
50	6,700	7,200	-	-	-	-	-
55	6,700	7,200	-	-	-	-	-
60	6,700	7,200	-	-	-	-	-
65	6,700	7,200	6,000	-	-	-	-
70	6,700	7,200	6,000	6,200	-	-	-
75	6,700	7,200	6,000	6,000	4,800	-	-
80	6,700	7,200	6,000	5,900	4,800	4,800	-
85	6,700	7,000	5,800	5,700	4,800	4,800	-
90	6,700	6,400	5,600	5,600	4,700	4,700	-
95	6,200	5,900	5,500	5,400	4,600	4,500	-
100	5,700	5,400	5,400	5,200	4,500	4,500	-
105	5,200	5,000	5,200	5,000	4,400	4,300	-
110	4,700	4,700	5,100	4,700	4,300	4,300	-
115	4,300	4,300	4,700	4,400	4,200	4,200	-
120	3,900	4,000	4,300	4,100	4,100	4,100	-
125	3,600	3,700	4,000	3,800	4,000	3,900	-
130	3,100	3,500	3,600	3,600	3,800	3,600	-
135	2,700	3,200	3,300	3,300	3,500	3,400	-
140	2,300	3,000	3,000	3,100	3,200	3,200	-
145	1,900	2,700	2,600	2,900	2,900	2,900	-
150	1,600	2,400	2,200	2,700	2,600	2,700	-
155	1,300	2,100	1,900	2,500	-	2,500	-
160	-	1,800	1,500	2,200	-	-	-
1)	1	2	1	2	1	2	



Smart Chart

1) Telescopic mode

Fully extended – 360° – Smart Chart

9,600 lb								23' 11-3/8" x 24' 0-5/8"								360°							
				125.5' + 33.2'								125.5' + 58.1'											
		3.5°		25°		45°				3.5°		25°		45°									
ft		1,000 lb						ft		1,000 lb													
35	14,600	11,500	-	-	-	-	35	-	-	-	-	-	-	-									
40	14,600	11,500	-	-	-	-	40	-	7,200	-	-	-	-	-									
45	14,600	11,500	12,600	10,900	-	-	45	8,700	7,200	-	-	-	-	-									
50	14,600	11,500	12,600	10,900	-	-	50	8,700	7,200	-	-	-	-	-									
55	14,200	11,500	12,500	10,900	10,000	9,100	55	8,700	7,200	-	-	-	-	-									
60	12,800	10,500	12,000	10,100	9,800	9,100	60	8,700	7,200	-	-	-	-	-									
65	11,500	9,500	11,600	9,300	9,600	8,800	65	8,700	7,200	6,700	6,300	-	-	-									
70	10,400	8,600	10,500	8,600	9,400	8,300	70	8,500	7,200	6,400	6,300	-	-	-									
75	9,500	7,900	9,600	7,900	9,200	7,800	75	8,100	7,200	6,200	6,100	5,100	4,800	-									
80	8,700	7,200	8,800	7,300	8,900	7,300	80	7,800	7,000	6,000	5,900	4,900	4,800	-									
85	7,900	6,600	8,100	6,700	8,200	6,700	85	7,500	6,400	5,900	5,700	4,800	4,700	-									
90	7,300	6,100	7,400	6,200	7,500	6,200	90	7,200	5,900	5,700	5,600	4,700	4,600	-									
95	6,700	5,600	6,800	5,700	6,900	5,700	95	6,600	5,400	5,500	5,300	4,600	4,500	-									
100	6,100	5,100	6,300	5,200	6,300	5,300	100	6,100	5,000	5,300	5,000	4,500	4,400	-									
105	5,600	4,700	5,800	4,800	5,900	4,900	105	5,600	4,600	5,200	4,700	4,300	4,300	-									
110	4,900	4,400	5,300	4,500	5,400	4,500	110	5,100	4,200	5,000	4,400	4,300	4,200	-									
115	4,300	4,000	4,800	4,100	5,000	4,200	115	4,700	3,900	4,900	4,100	4,200	4,100	-									
120	3,700	3,700	4,100	3,800	-	-	120	4,400	3,600	4,700	3,800	4,100	3,900	-									
125	3,200	3,400	3,600	3,500	-	-	125	3,800	3,300	4,300	3,500	4,000	3,600	-									
130	2,700	3,200	3,000	3,200	-	-	130	3,400	3,000	3,900	3,200	4,000	3,300	-									
135	2,300	2,900	2,500	3,000	-	-	135	2,900	2,800	3,600	3,000	3,800	3,000	-									
140	1,900	2,700	2,100	2,800	-	-	140	2,500	2,600	3,200	2,700	3,400	2,800	-									
145	1,500	2,500	-	-	-	-	145	2,200	2,400	2,700	2,500	-	-	-									
150	-	2,300	-	-	-	-	150	1,800	2,200	2,300	2,300	-	-	-									
155	-	-	-	-	-	-	155	1,500	2,000	1,900	2,100	-	-	-									
160	-	-	-	-	-	-	160	1,200	1,800	1,600	1,900	-	-	-									
1)	1	2	1	2	1	2	1)	1	2	1	2	1	2										



Smart Chart

1) Telescopic mode

Notes to Lifting Capacity

GENERAL

1. RATED LIFTING CAPACITIES apply only to the machine as originally manufactured and normally equipped by TADANO LTD. Modifications to the machine or use of optional equipment other than that specified can result in a reduction of capacity.
2. Hydraulic cranes can be hazardous if improperly operated or maintained. Operation and maintenance of this machine must be in compliance with information, in the operation manual supplied with the crane. If this manual is missing, order a replacement through the distributor.
3. The operator and other personnel associated with this machine shall fully acquaint themselves with the latest American National Standards Institute (ANSI) safety standards for cranes.

SET UP

1. Rated lifting capacities on the chart are the maximum allowable crane capacities and are based on the machine standing level on firm supporting surface under ideal job conditions. Depending on the nature of the supporting surface, it may be necessary to have structural supports under the outrigger floats or tires to spread the loads to a larger bearing surface.
2. For outrigger operation, outriggers shall be properly extended with tires free of supporting surface before operating crane.

OPERATION

1. Rated lifting capacities have been tested to and meet minimum requirements of SAE J1063-Cantilevered Boom Crane Structures Method of Test. Rated lifting capacities do not exceed 85% of the tipping load on outriggers fully extended as determined by SAE J765 -Crane Stability Test Code.
2. Rated lifting capacities for partially extended outriggers are determined from the formula, rated lifting capacities = (tipping load - 0.1 × tip reaction) / 1.25.
3. Rated lifting capacities are based on actual load radius increased by boom deflection.
4. The weight of handling device such as hook blocks, slings, etc., must be considered as part of the load and must be deducted from the lifting capacities.
5. Rated lifting capacities are based on freely suspended loads and make no allowance for such factors as the effect of wind, sudden stopping of loads, supporting surface conditions, inflation of tires, operating speeds, side loads, etc. Side pull on boom or jib is extremely dangerous. Such action can damage the boom, jib or slewing mechanism, and lead to overturning of the crane.
6. Rated lifting capacities do not account for wind on lifted load or boom. We recommend against working under the condition that the load is out of control due to a strong wind. During boom lift, consider that the rated lifting capacity is reduced by 50% when the wind speed is 20 mph to 27 mph; reduced by 70% when the wind speed is 27 mph to 31 mph. If the wind speed is 31 mph or over, stop operation. During jib lift, stop operation if the wind speed is 20 mph or over.
7. Rated lifting capacities at load radius shall not be exceeded. Do not tip the crane to determine allowable loads.
8. Do not operate at boom lengths, radii, or boom angle, where no capacities are shown. Crane may overturn without any load on the hook.
9. When boom length is between values listed, refer to the rated lifting capacities of the next longer and next shorter booms for the same radius. The lesser of the two rated lifting capacities shall be used.
10. When making lifts at a load radius not shown, use the next longer radius to determine allowable capacity.
11. Load per line should not exceed 14,600 lb for main winch and auxiliary winch.
12. Check the actual number of parts of line with LOAD MOMENT INDICATOR (AML-E2) before operation. Maximum lifting capacity is restricted by the number of parts of line of LOAD MOMENT INDICATOR (AML-E2). Limited capacity is as determined from the formula, single line pull for main winch 14,600 lb × number of parts of line.
13. The boom angle before loading should be greater to account for deflection. For rated lifting capacities, the loaded boom angle and the load radius is for reference only.
14. The 39.4' boom length capacities are based on boom fully retracted. If not fully retracted [less than 53.7' boom length], use the rated lifting capacities for the 53.7' boom length.
15. Extension or retraction of the boom with loads may be attempted within the limits of the RATED LIFTING CAPACITIES. The ability to telescope loads is limited by hydraulic pressure, boom angle, boom length, crane maintenance, etc. For lifting capacity of single top, deduct the weight of the load handling equipment from the rated lifting capacity of the boom.
16. For the lifting capacity of single top, the net capacity shall not exceed 14,600 lb including the main boom hook mass attached to the boom.
17. When the base jib or top jib or both jibs are removed, set the jib state switch to the REMOVED position.
18. When erecting and stowing jib, be sure to retain it by hand or by other means to prevent its free movement.
19. Use "ANTI-TWOBLOCK" disable switch when erecting and stowing jib and when stowing hook block. While the switch is pushed, the hoist does not stop, even when overwind condition occurs.
20. When lifting a load by using jib (aux. winch) and boom (main winch) simultaneously, do the following:
 - Enter the operation status as jib operation, not as boom operation.
 - Before starting operation, make sure that mass of load is within rated lifting capacity for jib.
21. Before telescoping the boom, set the telescoping mode selector switch to mode 1 or mode 2 fully retracted. A change of the telescoping mode is not permissible when the boom has been partially or fully extended.
22. Crane operation is prohibited without full counterweight 9,600 lb installed. Outriggers shall be extended 23' 11-3/8" spread when installing or removing removable counterweight.

DEFINITIONS

1. Load radius: Horizontal distance from a projection of the axis of rotation to supporting surface before loading to the center of the vertical hoist line or tackle with load applied.
2. Loaded boom angle: The angle between the boom base section and the horizontal, after lifting the rated lifting capacity at the load radius.
3. Working area: Area measured in a circular arc about the centerline of rotation.
4. Freely suspended load: Load hanging free with no direct external force applied except by the hoist line.
5. Side load: Horizontal side force applied to the lifted load either on the ground or in the air.

Warning and Operating Instructions for on Rubber Lifting Capacities

1. Rated lifting capacities on-rubber are in pounds and do not exceed 75% of tipping loads as determined by SAE J765-Crane Stability Test Code.
2. Rated lifting capacities shown in the chart are based on condition that crane is set on firm level surfaces with suspension-lock applied. They are based on actual load radius increased by tire deformation and boom deflection.
3. If the suspension-lock cylinders contain air, the axle will not be locked completely and rated lifting capacities may not be obtainable. Bleed the cylinders according to the operation safety and maintenance manual.
4. Rated lifting capacities are based on proper tire inflation, capacity and condition. Damaged tires are hazardous to safe operation of crane.
5. Tires shall be inflated to correct air pressure. Tires: 29.5-25 34PR · Air pressure: 57 psi.
6. Over front operation shall be performed within 2 degrees in front of chassis.
7. On-rubber lifting with "jib" is not permitted. Maximum permissible boom length is 96.8 ft.
8. When making lift on-rubber stationary, set parking brake.
9. For creep operation, boom must be centered over front of machine, slewing lock engaged, and load restrained from slewing. Travel slowly and keep the lifted load as close to the ground as possible, and especially avoid any abrupt steering, accelerating or braking.
10. Do not operate the crane while carrying the load.
11. Creep is motion for crane not to travel more than 200 ft in any 30 minute period and to travel at the speed of less than 1 mph.
12. For creep operation, choose the drive mode and proper gear according to the road or working condition.

Notes for Load Moment Indicator (AML-E2)

1. Set AML select keys in accordance with the actually operating crane conditions and don't fail to make sure, before crane operation, that the displays on front panel are correct.
2. When operating crane on outriggers:
 - Set „P.T.O.“ switch to "ON"
 - Press the outrigger state select key to register for the outrigger operation. If the display agrees with the actual state, press the set key to register. After the completion of the registration, the display returns to the crane operation status.
 - Press the lift state select key to register the lift state to be used (single top/jib/boom).
 - Each time the lift state select key is pressed, the display changes. If the display agrees with the actual state, press the set key to register. After the completion of the registration, the display returns to the crane operation status.
 - When erecting and stowing jib, select the status of jib set (jib state indicative symbol lights up).
3. When operating crane on-rubber:
 - Set „P.T.O.“ switch to "ON"
 - Press the outrigger state select key to register for the on-rubber operation. Each time the outrigger state select key is pressed, the display changes. Select the creep operation, the on-rubber state indicator symbol lights up.
 - Press the lift state select key to register the lift state.However, pay attention to the following.
 - (1) For stationary operation.
 - The front capacities are attainable only when the over front position symbol comes on.
 - When the boom is more than 2 degrees from centered over front of chassis, 360° capacities are in effect.
 - When a load is lifted in the front position and then slewed to the side area, make sure the value of the LOAD MOMENT INDICATOR (AML-E2) is below the 360° lifting capacity.
 - (2) For creep operation.
 - The creep capacities are attainable only when boom is in the straight forward position of chassis and the over front position symbol is on.
 - If boom is not in the straight forward position of chassis, never lift load.
4. This machine is equipped with an automatic slewing stopping device (for the details, see operation manual). But, operate very carefully because the automatic slewing stop does not work in the following cases.
 - During on-rubber operation.
 - When the „P.T.O.“ switch is set to „OVERRIDE“ and the „OVERRIDE“ key switch outside the cab is on.
5. During crane operation, make sure that the displays on front panel are in accordance with actual operating conditions.
6. The displayed values of LOAD MOMENT INDICATOR (AML-E2) are based on freely suspended loads and make no allowance for such factors as the effect of wind, sudden stopping of loads, supporting surface conditions, inflation of tire, operating speed, side loads, etc. For safe operation, it is recommended when extending and lowering boom or slewing, lifting loads shall be appropriately reduced.
7. LOAD MOMENT INDICATOR (AML-E2) is intended as an aid to the operator. Under no condition should it be relied upon to replace use of capacity charts and operating instruction. Sole reliance upon LOAD MOMENT INDICATOR (AML-E2) aids in place of good operating practice can cause an accident. The operator must exercise caution to assure safety.
8. The lifting capacity differs depending on the outrigger extension width and slewing position. Work with the capacity corresponding to the outrigger extension width and slewing position. For the relationship among the outrigger extension width, slewing position and lifting capacities, refer to the working area charts.

TECHNICAL DESCRIPTION

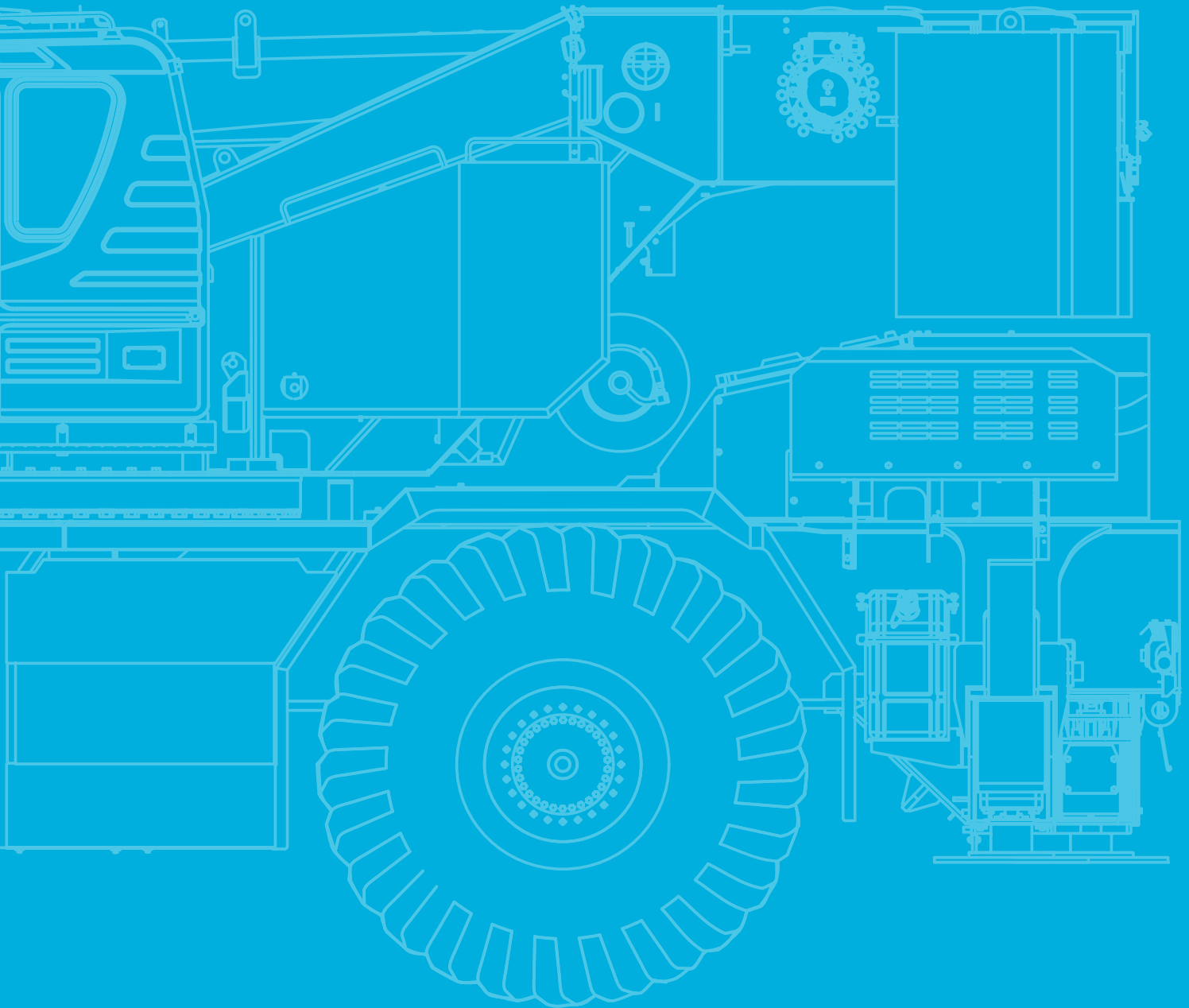

Technical Description

Crane specifications

Boom	5 section full power synchronized telescoping boom, 39.4' - 154.2', of round box construction with 5 sheaves, 17-5/16" root diameter, at boom head. The synchronization system consists of 2 telescope cylinders, an extension cable and retraction cable. Hydraulic cylinder fitted with holding valve. 2 easily removable wire rope guards, rope dead end provided on both sides of boom head. Boom telescope sections are supported by wear pads both vertically and horizontally. Extension speed 114.8' in 142 seconds.
Boom elevation	By a double acting hydraulic cylinder with holding valve. Elevation -1.5° - 80.5°, combination controls for hand or foot operation. Boom angle indicator. Automatic speed reduction and slow stop function. Boom raising speed 20° to 60° in 46 seconds.
Jib	2 stage bi-fold lattice type, 3.5°, 25° or 45° offset (tilt type). Single sheave, 15-5/8" root diameter, at the head of both jib sections. Stored alongside base boom section. Jib length is 33.2' or 58.1'. Assistant cylinders for mounting and stowing, controlled at right side of superstructure. Self stowing jib mounting pins.
Auxiliary lifting sheave (single top)	Single sheave, 15-5/8" root diameter. Mounted to main boom head for single line work (stowable).
Anti-two block	Pendant type over-winding cut out device with audio-visual (FAILURE lamp/BUZZER) warning system.
Slewing	Hydraulic axial piston motor through planetary slewing speed reducer. Continuous 360° full circle slewing on ball bearing turn table at 1.5 min ⁻¹ {rpm}. Equipped with manually locked/released slewing brake. A 360° positive slewing lock for pick and carry and travel modes, manually engaged in cab. Twin slewing system: Free slewing or lock slewing controlled by selector switch on front console.
Winch	<p>MAIN WINCH: Variable speed type with grooved drum driven by hydraulic axial piston motor through speed reducer. Power load lowering and raising. Equipped with automatic brake (neutral brake) and counterbalance valve. Controlled independently of auxiliary winch. Equipped with cable follower and drum rotation indicator.</p> <p>DRUM: Grooved 14-1/4" root diameter x 26-13/16" wide. Wire rope: 830' of 3/4" diameter rope. Drum capacity: 1135' 7 layers. Maximum single line pull: 1st layer 20,000 lb. Maximum permissible line pull wire strength: 14,600 lb.</p> <p>AUXILIARY WINCH: Variable speed type with grooved drum driven by hydraulic axial piston motor through speed reducer. Power load lowering and raising. Equipped with automatic brake (neutral brake) and counterbalance valve. Controlled independently of main winch. Equipped with cable follower and drum rotation indicator.</p> <p>DRUM: Grooved 14-1/4" root diameter x 26-13/16" wide. Wire rope: 456' of 3/4" diameter rope. Drum capacity: 1135' 7 layers. Maximum single line pull: 1st layer 20,000 lb. Maximum permissible line pull wire strength: 14,600 lb.</p> <p>WIRE ROPE: Non-rotating 3/4" P·S (19) + 39 x P·7 breaking strength 72,800 lb.</p>
Hook blocks	80 ton - 6 sheaves with swivel hook and safety latch, for 3/4" wire rope. 7.3 ton - Weighted hook with swivel and safety latch, for 3/4" wire rope.
Counterweight	9,600 lb.
Hydraulic system	<p>PUMPS: 2 variable piston pumps for crane functions. Tandem gear pump for steering slewing and other hydraulic systems. Powered by carrier engine. Pump disconnect for crane is engaged/disengaged by rotary switch from operator's cab.</p> <p>CONTROL VALVES: Multiple valves actuated by pilot pressure with integral pressure relief valves.</p> <p>RESERVOIR: 210 gallons capacity. External sight level gauge.</p> <p>FILTRATION: BETA10 = 10 return filter, full flow with bypass protection, located inside of hydraulic reservoir. Accessible for easy replacement.</p> <p>OIL COOLER: Air cooled fan type.</p>
Cab and controls	<p>Both crane and drive operations can be performed from one cab mounted on rotating superstructure. 20° tilt, left side, 1 man type, steel construction with sliding door access and safety glass windows opening at side. Door window is powered control. Windshield glass window and roof glass window are shatter-resistant. Tilt-telescoping steering wheel. Adjustable control lever stands for slewing, boom elevating, boom telescoping, auxiliary winch and main winch. Control lever stands can change neutral positions and tilt for easy access to cab. 3 way adjustable operator's seat with high back, headrest and armrest. Engine throttle knob. Foot operated controls: boom elevating boom telescoping, service brake and engine throttle. Hot water cab heater and air conditioning. Dash-mounted instrument panel, multi function display, starter switch (engine start/stop), 12 V power outlet, USB port, drive selector switch, parking brake switch, steering mode select switch, power window switch, pump engaged/disengaged switch, slewing brake switch, telescoping/auxiliary winch select switch, outrigger controls, free slewing/lock slewing selector switch, air conditioning control switch.</p> <p>Instruments panel: Torque converter oil temperature, engine water temperature, air pressure, fuel, speedometer, tachometer, hour meter and odometer/tripmeter.</p> <p>Multi function display: DEF level gauge, fuel consumption monitor.</p>

Technical Description

Crane specifications

Tadano electronic LOAD MOMENT INDICATOR system (AML-E2) including:
 Control lever lockout function with audible and visual pre-warning. Number of parts of line. Boom position indicator. Outrigger state indicator. Slewing angle. Boom angle / boom length / jib offset angle / jib length / load radius / rated lifting capacities / actual loads read out. Potential lifting height. Ratio of actual load moment to rated load moment indication. Automatic speed reduction and slow stop function on boom elevation and slewing. Working condition register switch. Load radius / boom angle / tip height / slewing range preset function. External warning lamp. Tare function. Main hydraulic oil pressure. Fuel consumption monitor. Main winch / auxiliary winch select. Drum rotation indicator (audible and visible type) main and auxiliary winch. On rubber indicator.

TADANO AML-E2 monitors outrigger extended length and automatically programs the corresponding „RATED LIFTING CAPACITIES“ table.

Operator's right hand console includes transmission gear selector, slewing lock lever and sight level bubble. Upper console includes, roof washer and wiper switch, emergency outrigger set up key switch, jib equipped / removed select switch, high speed winch (main/aux.) switch, cab tilt switch, pump disconnect enable switch and boom emergency telescoping switch (2nd and 3rd-top).

NOTE: Each crane motion speed is based on unladen conditions.

Carrier specifications

Type	Rear engine, left hand steering, driving axle 2-way selected type by manual switch, 4 x 2 front drive, 4 x 4 front and rear drive.
Frame	High tensile steel, all welded mono-box construction.
Engine	Model: Cummins B6.7 · Type: Direct injection diesel · No. of cylinders: 6 · Combustion: 4 cycle, turbo charged and after cooled · Bore x stroke: 4.212 in. x 4.882 in. · Displacement: 409 cu. in liters · Air inlet heater: 24 volt preheat · Air cleaner: Dry type, replaceable element · Oil filter: Full flow with replaceable element · Fuel filter: Full flow with replaceable element · Fuel tank: 79.2 gallons, right side of carrier · Cooling: Liquid pressurized, recirculating by-pass · Radiator: Fin and tube core, thermostat controlled · Fan: Suction type, 9-blade, 28 in. diameter · Starting: 24 volt · Charging: 24 volt system, negative ground · Battery: 2-120 amp. hour · Compressor, air: 17.0 cfm @ 2,400 rpm · Output, max.: Gross 280 HP (209 kW) @ 2,200 rpm · Torque, max.: 850 ft-lb (1,152 Nm) @ 1,500 rpm · Capacity: Cooling water 2.7 gallons, lubrication 4.0 gallons, fuel 79.2 gallons, DEF/AdBlue 15.0 gallons.
Transmission	Electronically controlled full automatic transmission. Torque converter driving full powershift with driving axle selector. 6 forward and 2 reverse speeds, constant mesh. 3 speeds - high range - 2 wheel drive; 4 wheel drive. 3 speeds - low range - 4 wheel drive.
Travel speed	22 mph.
Gradeability	79% (at stall), 57% (machine should be operated within the limit of engine crankcase design (30°: Cummins B6.7).
Axle	Front: Full floating type, steering and driving axle with planetary reduction. Rear: Full floating type, steering and driving axle with planetary reduction and non-spin rear differential.
Steering	Hydraulic power steering controlled by steering wheel. Four steering modes available: 2 wheel front, 2 wheel rear, 4 wheel coordinated and 4 wheel crab.
Suspension	Front: Rigid mounted to frame. Rear: Pivot mounted with hydraulic lockout device.
Brake systems	Service: Air over hydraulic disc brakes on all 4 wheels. Parking / Emergency: Spring applied-air released brake acting on input shaft of front axle. Auxiliary: Electropneumatic operated exhaust brake.
Tires	29.5-25 34PR (OR). Air pressure: 57 psi.
Outriggers	Four hydraulic, beam and jack outriggers. Vertical jack cylinders equipped with integral holding valve. Each outrigger beam and jack is controlled independently from cab. Beams extend to 23' 11-3/8" center-line and retract to within 10' 10-1/2" overall width with floats. Outrigger jack floats are attached thus eliminating the need of manually attaching and detaching them. Controls and sight bubble located in superstructure cab. Four outrigger extension lengths are provided with corresponding „RATED LIFTING CAPACITIES“ for crane duty in coned areas. Min. extension: 8' 10-1/4" center to center Mid. extension: 18' 1/2" center to center Mid. extension: 21' 11-3/4" center to center Max. extension: 23' 11-3/8" center to center Float size (diameter): 1' 11- 5/8"

Technical Description

Standard equipment

5 section full power partially synchronized boom	39.4' – 154.2'
Bi-fold lattice jib (tilt type)	33.2' or 58.1' – With 3.5°, 25° or 45° pinned offsets and self storing pins.
Quick reeving type bi-fold jib	
Anti-two block device	Overwind cutout.
Winch drum camera with light	
LED work lights	
Variable speed main winch	With grooved drum, cable follower, drum rotation indicator (audible, visible and thumper type) and 830' of 3/4" cable.
Variable speed auxiliary winch	With grooved drum, cable follower, drum rotation indicator (audible, visible and thumper type) and 456' of 3/4" cable.
Auxiliary lifting sheave	Single top, stowable.
2-speed winch	
Hook block	80 ton, 6 sheaves with swivel hook and safety latch for 3/4" wire rope.
Hook	7.3 ton, with swivel.
Tadano twin slewing system and 360° positive slewing lock	
Positive control	
Hydraulic oil cooler	
3 way adjustable cloth seat	With armrests, high back and seat belt.
Tilt-telescoping steering wheel	
Tinted safety glass and sun visor	
Front windshield wiper and washer	
Roof window wiper and washer	
Power window	Cab door.
12 V power outlet	
Ashtray	
Cab floor mat	
Pump disconnect in operator's cab	
Air conditioner	Hot water heater and cooler.
Full instrumentation package	
Self centering finger control levers	With pilot control.
Control pedals	For boom elevating and boom telescoping.
Warning device (visual)	Low oil pressure / high water temperature.
Air cleaner dust indicator	
Cup holder	
Battery disconnect	
USB port	
20° tilt cab	
Emergency steering system	
Tadano electronic load moment indicator system (AML-E2)	
Boom angle indicator	

Technical Description

Standard equipment

Outrigger extension length detector

Electronic crane monitoring system

Rear view camera

Right front view camera

Fenders

Air dryer

Complete highway light package

Towing hooks Front and rear.

Hook block tie down Front bumper.

Weighted hook storage compartment

Halogen head lamp

Independently controlled outriggers

Four outrigger extension positions

Self-storing outrigger pads

Electronic controlled automatic transmission driven by torque converter

Drive / steer 4 x 4 x 4.

Non-spin rear differential

Automatic rear axle oscillation lockout system

Tires 29.5-25 34 PR.

Disc brakes

Water separator with filter High filtration.

Back-up alarm

24 volt electric system

Tool storage compartment

Tire inflation kit

Engine Cummins B6.7 turbo charged after cooled engine (280 HP) with exhaust brake.

Engine over-run alarm

Lifting eyes

Telematics Machine data logging and monitoring system with HELLO-NET via internet (availability depends on countries).

Fuel consumption monitor

Eco mode system

Radiator cover

Clearance sonar Rear side.

Automatic pump disconnect

Over unwinding prevention

Optional equipment

Auxiliary power unit

tac.sales@tadano.com
www.tadanoamericas.com

Tadano PanAmerican Operations
4242 W Greens Road, Houston, TX 77066
Phone: +1 (281) 869-0030



Lifting your dreams

